

DEPARTMENT OF THE ARMY  
TECHNICAL MANUAL

TM 9-8014

DEPARTMENT OF THE AIR  
FORCE TECHNICAL ORDER

TO 36A-1-401

---

OPERATION AND ORGANIZATIONAL  
MAINTENANCE

1/4-TON 4 x 4

UTILITY TRUCK

M38A1 AND 1/4-TON

4 x 4

FRONT LINE  
AMBULANCE

M170

---

This manual is correct to 25 January 1955

\*TM 9-8014/TO 36A-1-401

TECHNICAL MANUAL } DEPARTMENTS OF THE ARMY AND  
No. 9-8014 } THE AIR FORCE  
TECHNICAL ORDER }  
No. 36A-1-401 } WASHINGTON 25, D. C., 6 April 1955

## OPERATION AND ORGANIZATIONAL MAINTENANCE:

### ¼-TON 4 x 4 UTILITY TRUCK M38A1 AND ¼-TON 4 x 4 FRONT LINE AMBULANCE M170

	Paragraphs	Page
CHAPTER 1. INTRODUCTION		
Section I. General.....	1-3	3-4
II. Description and data.....	4-7	5-18
CHAPTER 2. OPERATING INSTRUCTIONS		
Section I. Service upon receipt of materiel.....	8-11	20-22
II. Controls and instruments.....	12-40	22-33
III. Operation under usual conditions.....	41-52	33-39
IV. Operation of ambulance equipment.....	53-58	41-49
V. Operation under unusual conditions.....	59-64	50-55
CHAPTER 3. ORGANIZATIONAL MAINTENANCE IN- STRUCTIONS		
Section I. Parts, special tools, and equipment for opera- tion and organizational maintenance.....	65-68	57
II. Lubrication and painting.....	69-75	59-69
III. Preventive maintenance services.....	76-79	69-73
IV. Troubleshooting.....	80-103	79-99
V. Engine description and maintenance in vehicle.....	104-118	99-122
VI. Engine removal and replacement.....	119-125	123-135
VII. Cooling system.....	126-132	136-142
VIII. Fuel and air intake system.....	133-142	143-161
IX. Exhaust system.....	143-146	164-166
X. Ignition system.....	147-153	167-179
XI. Starting system.....	154-156	180-183
XII. Generating system.....	157-160	184-192
XIII. Batteries and lighting system.....	161-171	194-215
XIV. Instrument cluster, instruments, gages, switches, sending units, and horn.....	172-189	216-230
XV. Clutch.....	190, 191	230, 231
XVI. Transmission.....	192-196	232-235
XVII. Transfer.....	197-200	236-239
XVIII. Propeller shafts with universal joints.....	201-205	239-245
XIX. Front axle.....	206-214	245-259
XX. Rear axle.....	215-221	259-264
XXI. Steering system.....	222-230	264-275
XXII. Brake systems.....	231-238	275-289
XXIII. Springs and shock absorbers.....	239-247	290-299

\*This manual supersedes TM 9-804A/TO 19-75AA-98, 21 July 1952, including C 1, 20 April 1953.



<b>CHAPTER 3. ORGANIZATIONAL MAINTENANCE</b>	<i>Paragraphs</i>	<i>Page</i>
<b>INSTRUCTIONS—Continued</b>		
Section XXIV. Wheels and tires.....	248-252	299-304
XXV. Body and frame (M38A1).....	253-261	304-329
XXVI. Body and frame (M170).....	262-272	329-347
XXVII. Maintenance under unusual conditions....	273-277	347-350
XXVIII. Radio interference suppression.....	278-282	351, 352
<b>CHAPTER 4. SHIPMENT AND LIMITED STORAGE</b>		
<b>AND DESTRUCTION OF MATERIEL</b>		
<b>TO PREVENT ENEMY USE</b>		
Section I. Shipment and limited storage.....	283-287	353-364
II. Destruction of materiel to prevent enemy use.....	288-292	365-367
<b>APPENDIX. REFERENCES.....</b>		<b>368</b>
<b>INDEX.....</b>		<b>372</b>

# CHAPTER 1

## INTRODUCTION

---

### Section I. GENERAL

#### 1. Scope

*a.* These instructions are published for information and guidance of the personnel to whom this material is issued. They contain information on the operation and organizational maintenance of the materiel as well as descriptions of major units and their functions in relation to other components of the materiel.

*b.* The appendix contains a list of current references, including supply manuals, forms, technical manuals, and other available publications applicable to the materiel.

*c.* This manual differs from TM 9-804A, 21 July 1952, as shown below.

- (1) Adds information on the  $\frac{1}{4}$ -ton 4 x 4 front line ambulance M170.
- (2) Revises information on—name, caution, and instruction plates; tabulated data; controls and instruments; lubrication order; preventive maintenance services; troubleshooting; special tools, fuel lines, propeller shafts with universal joints, clutch controls and linkage, and springs and toe-in adjustment.
- (3) Deletes reference to—engine oil pan replacement, clutch replacement, Pitman arm replacement, and engine tuneup.

*d.* This edition is being published in advance of complete technical review of all concerned. Any errors or omissions will be brought to the attention of Chief of Ordnance, Washington 25, D. C., ATTN: ORDFM-Pub.

#### 2. Organizational Maintenance Allocation

In general, the prescribed organizational maintenance responsibilities will apply as reflected in the allocation of tools and spare parts in the appropriate columns of the current ORD 7 supply manual pertaining to this vehicle and in accordance with the extent of disassembly prescribed in this manual for the purpose of cleaning, lubricating, or replacing authorized spare parts. In all cases where the nature of repair, modification, or adjustment is beyond the scope or

facilities of the using organization, the supporting ordnance maintenance unit should be informed in order that trained personnel with suitable tools and equipment may be provided or other proper instructions issued.

*Note.* The replacement of certain assemblies (engine, transmission, transfer, front axle, and rear axle) is normally an ordnance maintenance operation, but may be performed in an emergency by the using organization, provided approval for performing these replacements is obtained from the supporting ordnance officer. A replacement assembly, any tools needed for the operation which are not carried by the using organization, any necessary special instructions regarding associated accessories, etc., may be obtained from the supporting ordnance maintenance unit.

### **3. Forms, Records, and Reports**

*a. General.* Responsibility for the proper execution of forms, records, and reports rests upon the officers of all units maintaining this equipment. However, the value of accurate records must be fully appreciated by all persons responsible for their compilation, maintenance, and use. Records, reports, and authorized forms are normally utilized to indicate the type, quantity, and condition of materiel to be inspected, to be repaired, or to be used in repair. Properly executed forms convey authorization and serve as records for repair or replacement of materiel in the hands of troops and for delivery of materiel requiring further repair to ordnance shops in arsenals, depots, etc. The forms, records, and reports establish the work required, the progress of the work within the shops, and the status of the materiel upon completion of its repair.

*b. Authorized Forms.* The forms generally applicable to units operating and maintaining these vehicles are listed in the appendix. No forms other than those approved for the Department of the Army will be used. Pending availability of all forms listed, old forms may be used. For a current and complete listing of all forms, refer to SR 310-20-6.

*c. Field Report of Accidents.* The reports necessary to comply with the requirements of the Army safety program are prescribed in detail in the SR 385-10-40 series of special regulations. These reports are required whenever accidents involving injury to personnel or damage to materiel occur. In addition to any applicable reports required above, details of the accident will be reported as prescribed in SR 385-310-1.

*d. Report of Unsatisfactory Equipment or Materials.* Suggestions for improvement in design and maintenance of equipment and spare parts, safety and efficiency of operation, or pertaining to the application of prescribed petroleum fuels, lubrication, and/or preserving materials, or technical inaccuracies will be reported through technical channels, as prescribed in SR 700-45-5, to the Chief of Ordnance,

Washington 25, D. C., ATTN: ORDFM, using DA Form 468, Unsatisfactory Equipment Report. Such suggestions are encouraged in order that other organizations may benefit.

*Note.* Do not report all failures that occur. Report only REPEATED or RECURRENT failures or malfunctions which indicate unsatisfactory design or material. However, reports will always be made in the event that exceptionally costly equipment is involved. See also SR 700-45-5 and printed instructions on DA Form 468.

## Section II. DESCRIPTION AND DATA

### 4. Description

*a. General.* This manual describes and illustrates the ¼-ton 4 x 4 utility truck M38A1 (figs. 1, 2, and 3), and the ¼-ton 4 x 4 front line ambulance M170 (figs. 4 and 5). With the exception of the differences discussed in paragraph 5, both vehicles are similar. The descriptions of individual components listed below apply to both models.

*b. Engine* (fig. 36). Power is supplied by an F-head, four-cylinder, four-cycle, water-cooled, gasoline-type engine. This type of engine is a combination valve-in-block and valve-in-head construction and is three-point mounted on the frame.

*c. Transmission.* The synchromesh transmission (fig. 126) is mounted on the rear of the engine. The transmission has three forward speeds and one reverse speed, all manually selected by means of the transmission gearshift lever (X, fig. 11) mounted on top of the transmission and extending into the driver's compartment.

*d. Transfer.* The transfer (fig. 126) is a two-speed unit driven by the transmission and distributes power to the front and rear axles through propeller shafts. The transfer is manually controlled by the transfer front wheel drive, and the high and low range gearshift levers (T, fig. 11), located on top of the transfer and extending into the driver's compartment. These levers provide for engaging or disengaging the front axle and selecting the high or low transfer ratio.

*e. Front Axle and Suspension.*

- (1) The front axle (fig. 152) is a full-floating, single reduction type equipped with a conventional differential with hypoid drive gears. The axle shafts (fig. 136) are fitted to universal joints which revolve within steering knuckles constructed as part of the axle housing. The front propeller shaft transmits power from the transfer to the front axle.
- (2) The front suspension consists of two semielliptic-type leaf springs (fig. 164). The rear of the springs are shackled to the underside of the frame by U-bolt-type shackles. Pivot bolts are used to secure the front ends of the springs to the frame brackets on the frame underside. U-bolts secure the



*Figure 1. 1/4-ton 4 x 4 utility truck M38A1—left front view.*

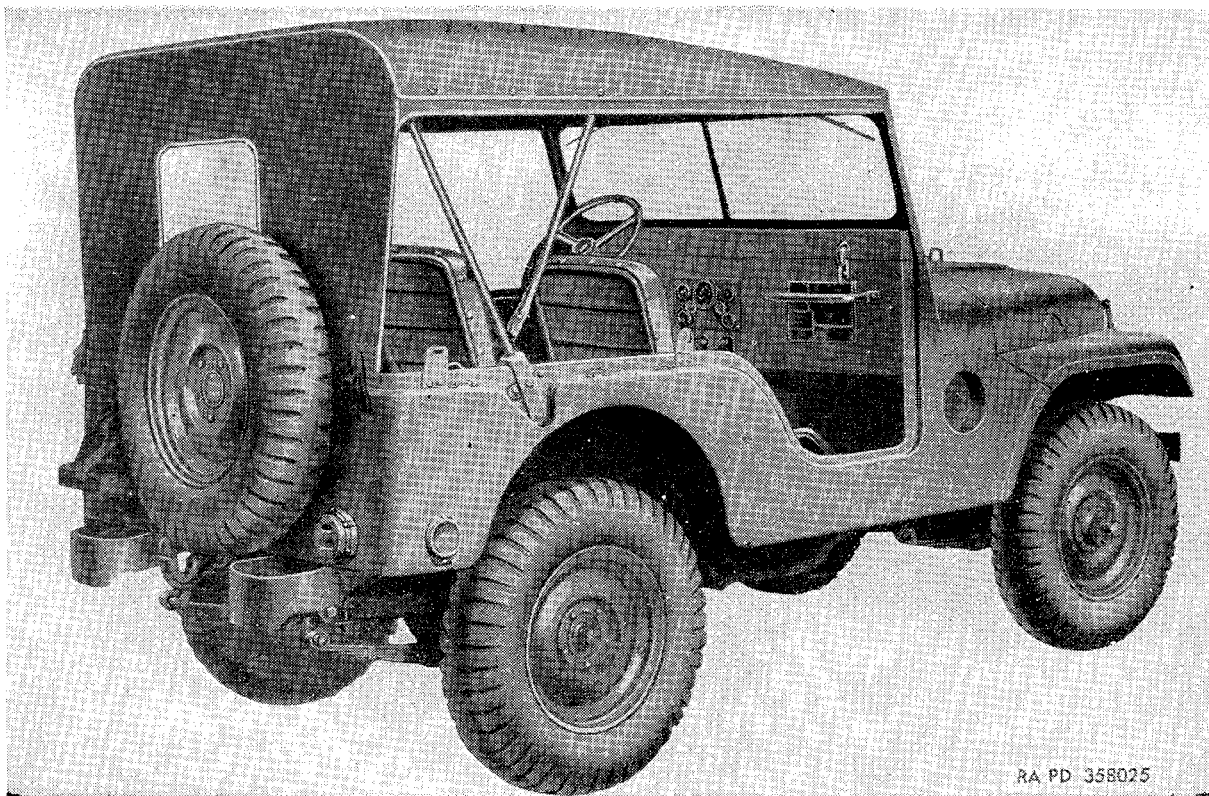
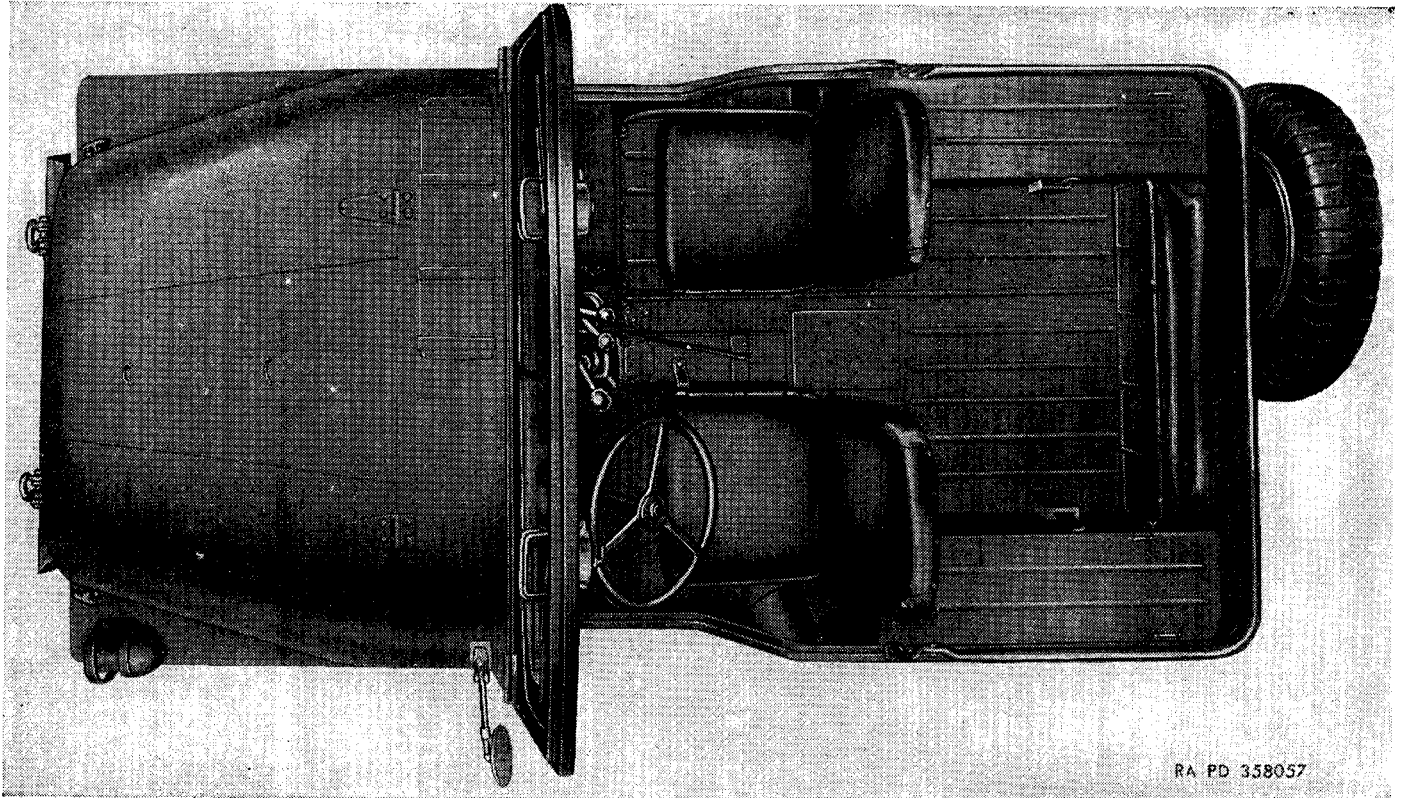
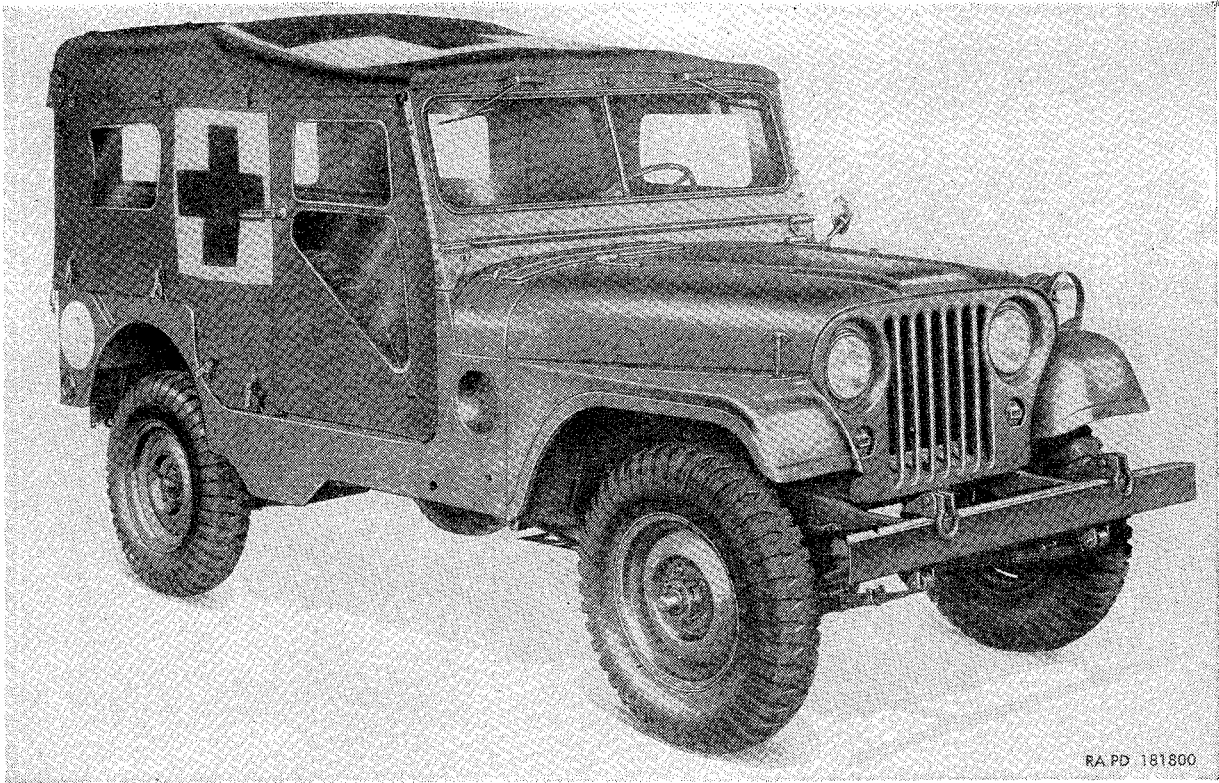

Figure 2.  $\frac{1}{4}$ -ton 4 x 4 utility truck M38A1—right rear view.



RA PD 358057

Figure 3.  $\frac{1}{4}$ -ton 4 x 4 utility truck M38A1—top view.



RA PD 181800

*Figure 4. 1/4-ton 4 x 4 front line ambulance M170—right front view.*



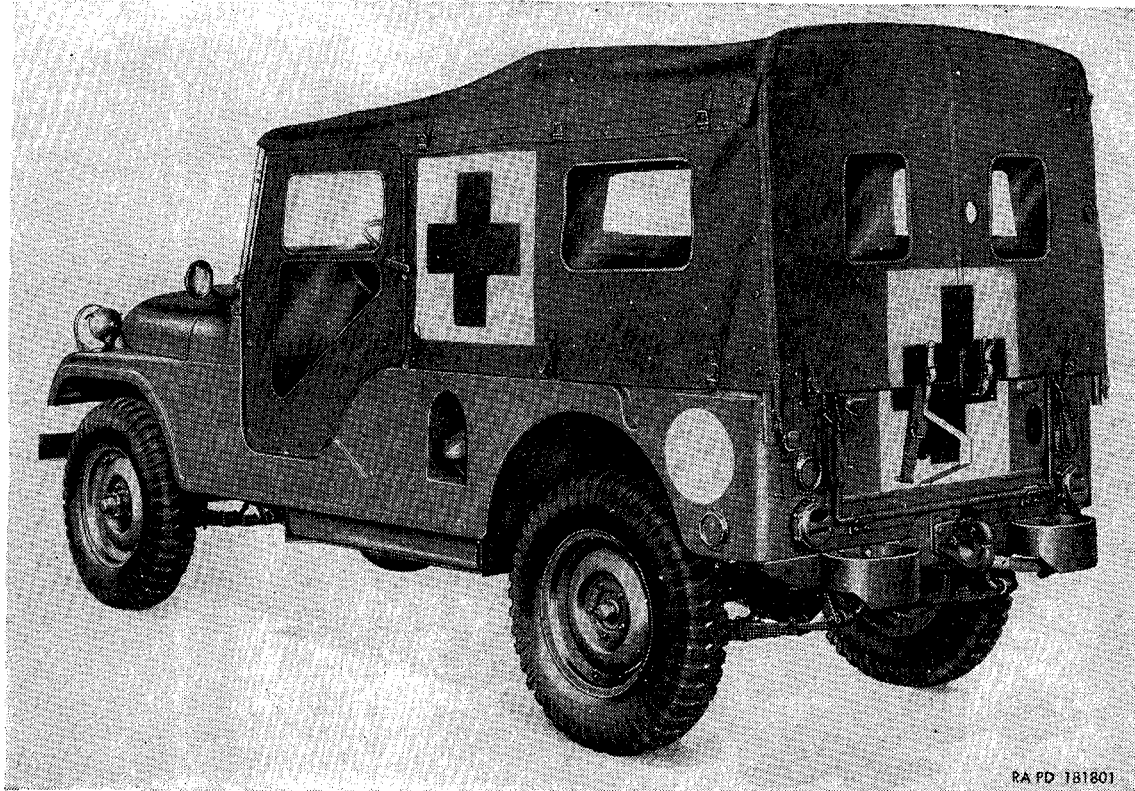

RA PD 181801

*Figure 5. 1/4-ton 4 x 4 front line ambulance M170—left rear view.*

springs to the axle housing. Two direct-action, two-way control shock absorbers are provided for dampening the front spring action.

*f. Rear Axle and Suspension.*

- (1) The rear axle (fig. 152) is a semifloating, single-reduction-type equipped with a conventional differential with hypoid drive gears. The rear propeller shaft transmits power from the transfer to the rear axle.
- (2) The rear suspension consists of two semielliptic-type leaf springs (fig. 165). The rear ends of the springs are shackled to the frame brackets on the frame underside by U-bolt-type shackles. Pivot bolts are used to secure the front ends of the springs to the frame brackets on the frame underside. U-bolts secure the springs to the axle housing. Two direct-action, two-way control shock absorbers are provided for dampening the rear spring action.

*g. Brake Systems.*

- (1) The service brake system (fig. 162) consists of hydraulic actuated brakes on all four wheels. Each brake assembly is of the floating, two-shoe design. Braking action (fig. 158) is controlled by the service brake pedal (N, fig. 13) in the driver's compartment.
- (2) The mechanical hand brake system serves primarily as a parking brake but can also be used to slow or stop the vehicle should the service brakes fail. The hand brake is shown installed in figure 163. The hand brake handle (Q, fig. 13), mounted within the driver's compartment, is connected to the operating lever mounted on the transfer beneath the vehicle.

*h. Electrical System* (figs. 75, 88, and 95). The electrical system is a 24-volt submersible-type equipped with two 12-volt lead-and-acid-type batteries, connected in series. All electrical components are waterproofed for operation while completely submerged. A trailer electrical coupling connector is located on the rear of the body on the M38A1 and an emergency reel lamp is located in the inside of the body, behind the driver's seat on the M170.

*i. Vehicle Nomenclature.* The terms "left" and "right" and "front" and "rear" are established with reference to the operator sitting in the driver's seat. "Right" indicates the direction to the right of the operator; "Left" the direction to the left of the operator. "Front" indicates the direction toward the radiator end of the vehicle; "Rear" the direction toward the back of the vehicle.

## **5. Differences Between Models**

*a.* The front line ambulance M170 can be distinguished from the utility truck M38A1 by its longer body and frame, designed for use

as an ambulance. The M170 longer wheel base and body provides accommodation for three litters. The litter carriers can be removed to convert the vehicle to a personnel carrier, accommodating six ambulatory patients in addition to the driver.

b. The ambulance tailgate can be lowered to facilitate loading of the litters. To permit tailgate lowering, the spare wheel, mounted on the right rear of the utility truck, is carried inside the ambulance at the right side of the front passenger seat.

c. The ambulance is equipped with lower rate springs and shock absorbers for easier riding. The hand brake has been modified to avoid interference with the left lower litter. Additional accessories, included with the ambulance, consist of crash pads and an interior emergency light.

## 6. Name, Data, Caution, and Instruction Plates

### a. Name and Data Plates.

- (1) *Vehicle identification plate* (figs. 6 and 7). This identification plate, located on the instrument panel at the right of the instrument cluster, includes vehicle name, serial number,

**FRONT**

TRANSMISSION	TRANSFER CASE
(R) (N) (1) (2) (3)	OUT (O) LOW (L) IN (I) (N) (H) HIGH (H)

FRONT AXLE DRIVE

DISENGAGE FRONT AXLE DRIVE WHEN OPERATING ON DRY HARD SURFACED ROADS

PUBLICATIONS  
PARTS LIST SNL G-758  
OPERATORS MANUAL TM-9-8014  
MAINTENANCE MANUALS  
TM-9-8015-1 TM-9-8015-2

SHIFTING INSTRUCTION PLATE

**WEIGHT AND DIMENSION DATA FOR TRUCK, UTILITY 1/4 TON 4 X 4 M 38 A 1**

WEIGHTS W/O CREW	EMPTY	CROSS COUNTRY	HIGH WAY
PAYLOAD	800	1200	
FRONT AXLE	1387	1591	1391
REAR AXLE	1278	2074	2474
TOTAL LBS*	2665	3465	3865
MAX TOWED LOAD (W/INFL TOWED)	1500	2000	

SHIPPING CUBAGE 350 CU FT

WEIGHT AND DIMENSION DATA PLATE

**CAUTION**  
MAXIMUM PERMISSIBLE ROAD SPEEDS IN THE FOLLOWING GEAR POSITIONS

TRANSMISSION	TRANSFER CASE IN	
	HIGH RANGE	LOW RANGE
HIGH	60 M P H	24 M P H
INTERMEDIATE	30	16
LOW	21	9
REVERSE	16	6

SPEED CAUTION PLATE

**SERVICING DATA. TRUCK 1/4 TON. 4 X 4. ELECTRICAL SYSTEM 24 V**

GASOLINE OCTANE NO	MIN 68	TIRE INFLATION PRESSURES	
GASOLINE TANK CAPACITY	17 GAL S	HIGHWAY	25 LBS
COOLING SYSTEM CAPACITY	11.5 QTS	CROSS COUNTRY	25 LBS
CRANKCASE CAPACITY	4.5 QTS	MUD, SAND OR SNOW	10 LBS

TEMPERATURE	ENGINE OIL	GEAR OIL	GREASE
ABOVE 32 F	OE GRADE 30	GO GRADE 90	CG GRADE CG-1
40 F TO 10 F	OE GRADE 10W	GO GRADE 75	CG GRADE CG-0
0 F TO 65 F	OE GRADE 0ES	GO GRADE GOS	CG GRADE OG-00

TO DRAIN COOLING SYSTEM OPEN RADIATOR COCK LOCATED ON BOTTOM OF RADIATOR ON LEFT SIDE AND CYL BLOCK DRAIN COCK ON RIGHT SIDE OF ENGINE BETWEEN GENERATOR & STARTER

SERVICING DATA PLATE

RESPONSIBLE AGENCY	PROCUREMENT	DEPOT MAINTENANCE
CHASSIS	ORDNANCE DEPT	ORDNANCE DEPT
BODY	ORDNANCE DEPT	ORDNANCE DEPT
MFD EQPT		

RESPONSIBLE AGENCY PLATE

**TRUCK, UTILITY, 1/4 TON, 4 X 4, M38A1**

ORD STOCK NO G 275B 8358119  
ORD SER NO [ ]

MFD BY WILLYS OVERLAND MOTORS INC TOLEDO O

MFR MODEL MD [ ] MFR SER NO [ ]

MFR PART NO 657323 DATE DEL [ ]

CONTRACT NO [ ] INSPECTED [ ]

DA 11 019 ORD 630

VEHICLE IDENTIFICATION PLATE

RA PD 181802

Figure 6. Name, data, caution, and instruction plates on instrument panel (M38A1).

manufacturer's name, part number, model number, contract number, and ordnance stock number.

- (2) *Servicing data plate* (figs. 6 and 7). This data plate, located on the instrument panel at the right of the instrument cluster, includes servicing information on the electrical system, fuel octane, tire inflation pressures, engine and gear oils, chassis grease, and cooling system, gasoline tank, and crankcase capacities.
- (3) *Responsible agency plate* (figs. 6 and 7). This data plate, located on the instrument panel to the right of the instrument cluster, provides a list of the agencies responsible for maintenance of various parts of the vehicle.
- (4) *Weight and dimension data plate* (figs. 6 and 7). This data plate, located on the instrument panel at the right of the instrument cluster, includes information on the vehicle dimensions, weights, and maximum towed loads.
- (5) *Engine serial number* (fig. 8). The manufacturer's serial number is stamped on the cylinder block behind the water pump and below the thermostat housing at the front of the engine.

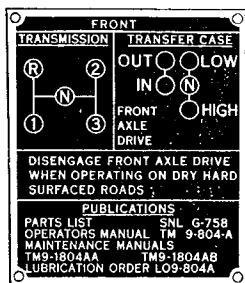

SHIFTING INSTRUCTION PLATE

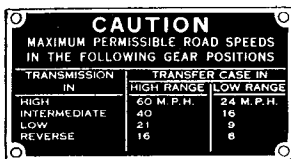

SPEED CAUTION PLATE

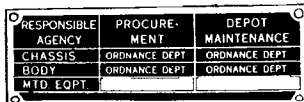

RESPONSIBLE AGENCY PLATE

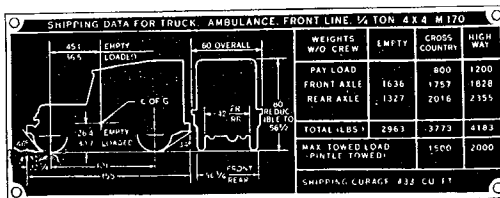

WEIGHT AND DIMENSION DATA PLATE

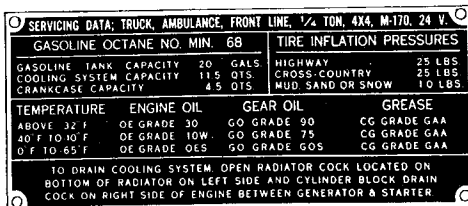

SERVICING DATA PLATE

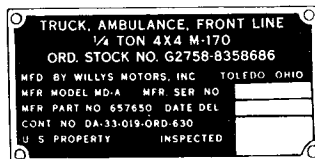

VEHICLE IDENTIFICATION PLATE

RA PD 181803

Figure 7. Name, data, caution, and instruction plates on instrument panel (M170).

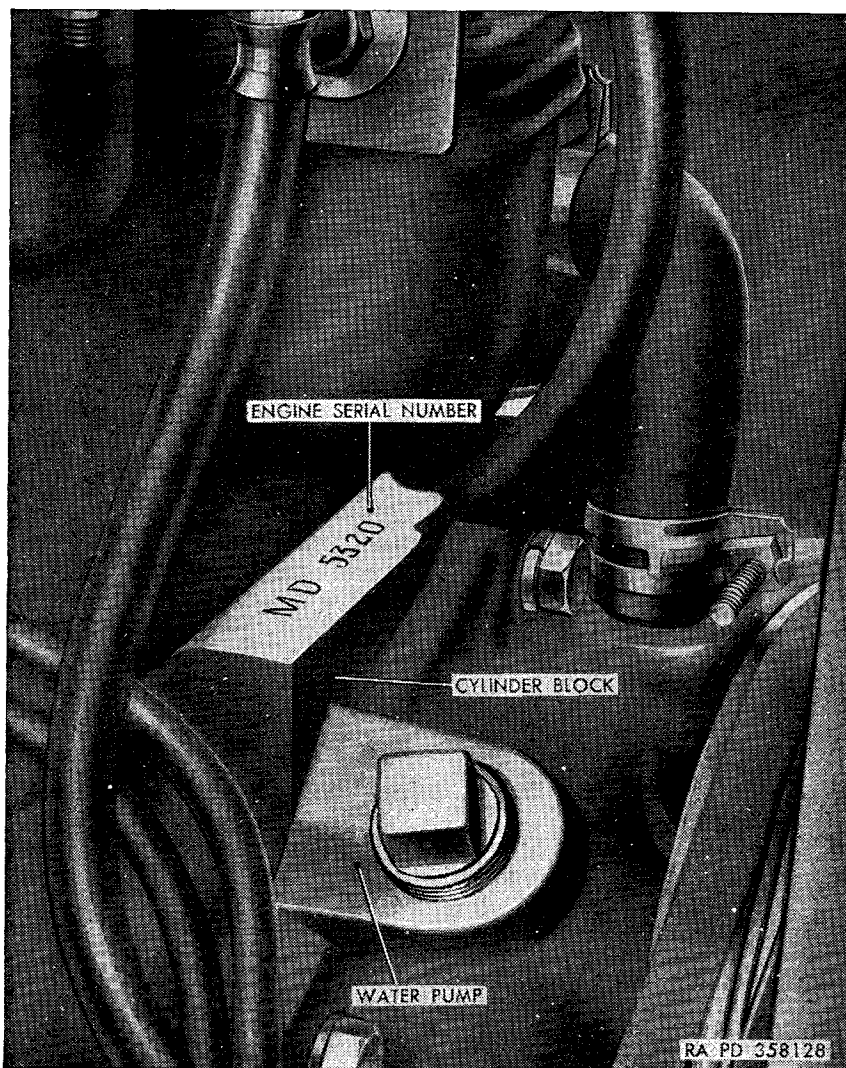

Figure 8. Engine serial number.

- (6) *Transmission, name, model, and serial number* (fig. 126). The transmission serial number (manufacturer's) is stamped on the top right rear corner of the transmission case. The transmission name and model number is stamped on the right rear side of the transmission case.
- (7) *Transfer name, model, and serial number* (fig. 126). The transfer serial number (manufacturer's) is stamped on top of the transfer case. The transfer name and model number are stamped on the rear of the transfer case.
- (8) *Distributor and ignition coil name and data plate* (fig. 10). This name and data plate, located on the right side of the

distributor and coil assembly, includes manufacturer's name, model number, voltage data, and ordnance number.

- (9) *Starter name and data plate* (fig. 10). This name and data plate, located on the left side of the starter, includes voltage, direction of rotation, ordnance part number, manufacturer's name, model number, and serial number.
- (10) *Generator name and data plate* (fig. 10). This name and data plate, located on the right side of the generator, includes ordnance part number, manufacturer's name, model number, voltage, amperage, and serial number.
- (11) *Generator regulator data plate* (fig. 10). This data plate, located on the right side of the generator regulator base, includes voltage rating, serial number, model number, ordnance number and capacity. The unit name is stamped on the generator regulator cover.
- (12) *Carburetor name and model number* (fig. 44). The carburetor name and model number is stamped on the side of the carburetor float bowl.
- (13) *Front axle shaft identification plate* (fig. 10). This plate, held by two of the screws securing the steering knuckle oil seal assemblies, identifies the type of joint used in the front axle assembly.
- (14) *Truck name, patent, and serial number plate* (fig. 9). This plate, attached to the top-front of the right rear wheel housing (immediately behind the front passenger seat), includes the truck name, patent number and serial number.
- (15) *Horn name and data plate* (fig. 10). This plate is attached to the horn bracket.

*b. Caution Plates.*

- (1) *Speed caution plate* (figs. 6 and 7). This caution plate, is located on the instrument panel to the right of the instrument cluster, provides information on permissible road speeds for various gear positions of the transmission and transfer.
- (2) *Generator regulator warning* (fig. 9). A warning is stamped on the front edge of the generator regulator cover and in the form of a decalcomania on the right front fender. This is a warning to disconnect the battery ground lead before working on generator or the generator regulator installations.

*c. Instruction Plates and Decalcomania.*

- (1) *Shifting instruction plate* (figs. 6 and 7). This instruction plate, located on the instrument panel at the right of the instrument cluster, provides a shifting diagram for the transmission and transfer. It also illustrates the shifting diagram to engage and disengage the front axle. A list of the applicable publications issued for the vehicle are also provided on this plate.

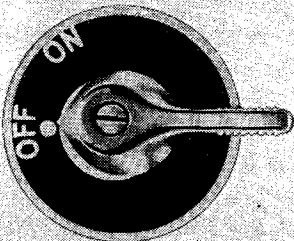

IGNITION SWITCH INSTRUCTION PLATE

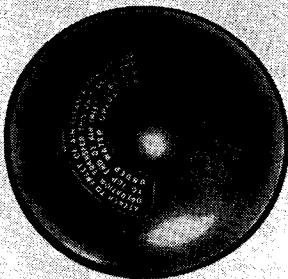

AIR PRE-CLEANER DECALOMANIA

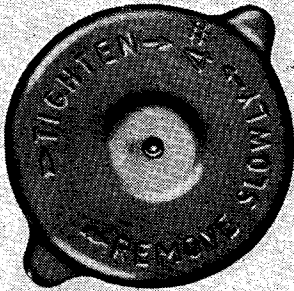

RADIATOR FILLER CAP CAUTION

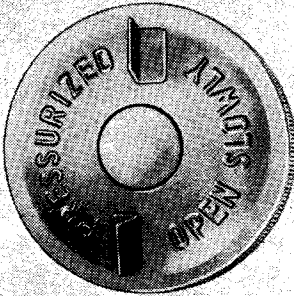

FUEL TANK FILLER CAP CAUTION

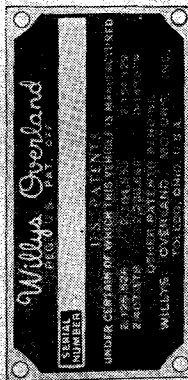

TRUCK, NAME, PATENT, AND SERIAL NUMBER PLATE



GENERATOR AND GENERATOR REGULATOR CABLE DISCONNECT DECALOMANIA



BELL HOUSING DRAIN PLUG DECALOMANIA

# HURRICANE-4

## ENGINE

VALVE CLEARANCE - COLD  
INTAKE .018 EXHAUST .016  
FIRING ORDER 1-3-4-2

VALVE CLEARANCE AND FIRING ORDER DECALOMANIA

RA PD 181804

Figure 9. Name, caution, instruction plates and decalomania.

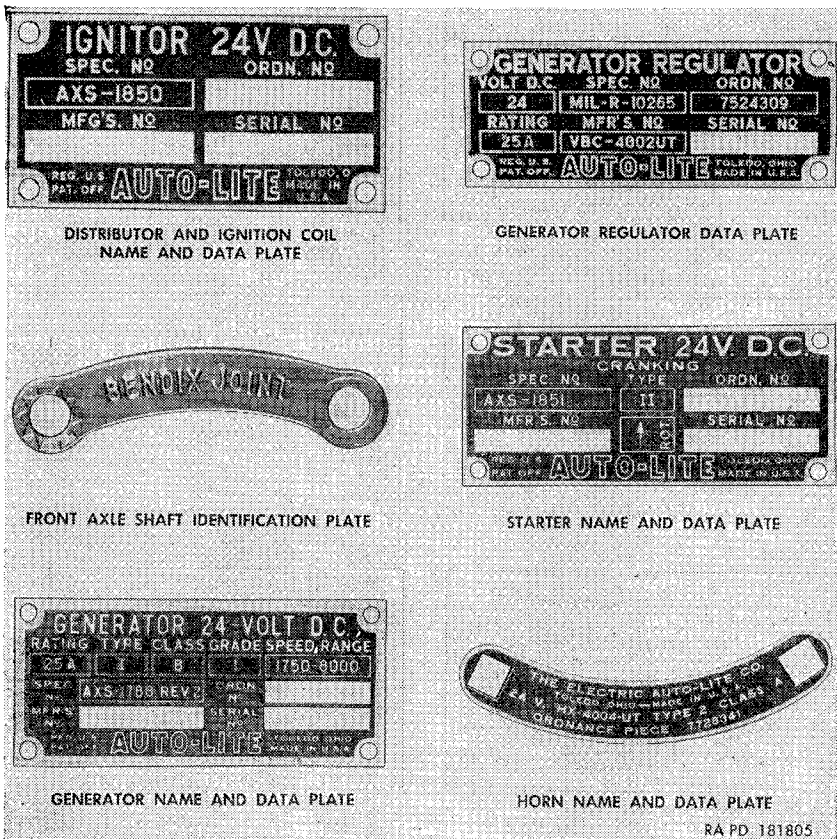

Figure 10. Name, data, control, and identification plates.

- (2) *Ignition switch instruction plate* (fig. 9). This plate, attached to the instrument panel just in front of the ignition switch lever, has OFF and ON imprinted on it to aid the operator in locating the correct positions of the ignition switch lever.
- (3) *Fuel tank filler cap caution* (fig. 9.) The fuel tank filler cap caution, embossed in the top of the filler cap, states that the fuel system is pressurized and instructs the operator to open the filler cap slowly.
- (4) *Radiator filler cap caution* (fig. 9). The radiator filler cap caution, embossed in the top of the cap, states to remove the cap slowly.
- (5) *Bell housing drain plug decalcomania* (fig. 9). This decalcomania, located on the bottom of the windshield assembly in the driver's compartment, states the stowage place of the bell housing drain plug, that the drain plug must be installed prior to fording, and that the plug must be removed after fording.



- (6) *Air precleaner decalomania* (fig. 9). This decalomania, located on the body of the air precleaner, states to attach the precleaner to inlet of air cleaner for regular operation and to transfer precleaner and its clamp to end of air inlet tube for underwater operation.
- (7) *Oil filter decalomanias* (fig. 66). The oil filter name decalomania, located on the side of the filter, gives the manufacturer's name, model number, and part number. The oil filter service decalomania, located on the head of the filter, provides servicing instructions.

## 7. Tabulated Data

### a. General data.

#### Capacities:

Cooling system	11½ qt
Crankcase (refill)	4½ qt
Differential (each)	2½ qt
Fuel tank (M38A1)	17 gal
Fuel tank (M170)	20 gal
Transmission	1 qt
Transfer	3 pt

Crew (operating)	1
Cylinders	4

#### Dimensions (M38A1):

Height, overall, maximum	73¾ in.
Height, lowest operable (over steering wheel)	56½ in.
Length, overall, maximum	138⅝ in.
Width, overall, maximum	60⅞ in.

#### Dimensions (M170):

Height, overall, maximum	78 in.
Height, lowest operable (over steering wheel)	56¼ in.
Length, overall, maximum	155 in.
Width, overall, maximum	60½ in.

Electrical system	24 volt
-------------------	---------

Ground clearance, minimum	9¼ in.
---------------------------	--------

Loading height (empty) (M38A1)	28 in.
--------------------------------	--------

Loading height (empty) (M170)	27¾ in.
-------------------------------	---------

Number of batteries	2
---------------------	---

#### Payload (maximum) (M38A1):

Cross country	800 lb
Highway	1,200 lb

Passengers (including crew) (M38A1)	4
-------------------------------------	---

Passengers (including crew) (M170)	
------------------------------------	--

Litter patients	4
-----------------	---

Ambulatory patients	7
---------------------	---

#### Tires:

Pressure	28 psi
----------	--------

Size	7.00 x 16
------	-----------

Towing pintle height (center of pintle)	21½ in.
---	---------

#### Tread:

Front	49⅛ in.
-------	---------

Rear	49⅜ in.
------	---------

Weight w/o crew (M38A1) :	
Cross country	3,465 lb
Empty	2,665 lb
Highway	3,865 lb
Weight w/o crew (M170) :	
Cross country	3,763 lb
Empty	2,963 lb
Highway	4,163 lb
Wheelbase (M38A1)	81 in.
Wheelbase (M170)	101 in.

*b. Performance.*

Allowable speed :	<i>1st</i>	<i>2d</i>	<i>3d</i>	<i>Reverse</i>
Transfer—high range	21	40	60	16 mph
Transfer—low range	9	16	24	6 mph
Angle (M38A1) :				
Approach	46°			
Departure	34°			
Cruising range (loaded)	280 mi			
Cruising speed	55 mph			
Engine horsepower : (brake horsepower) at 4,000 rpm	72 hp			
Fording depth	37½ in.			
Recommended towed load, maximum :				
Cross country	1,500 lb			
Highway	2,000 lb			
Turning circle, diameter (M38A1) :				
Left	38 ft			
Right	38 ft 8 in.			
Turning circle, diameter (M170) :				
Left	24 ft 2 in.			
Right	24 ft 7 in.			

*c. Detailed Data References.* Additional detailed tabular data pertaining to individual components and systems are contained in the following paragraphs:

	<i>Paragraph</i>
Batteries and lighting system	161
Body and frame (M38A1)	253
Body and frame (M170)	262
Brake systems	231
Clutch	190
Cooling system	126
Engine	104
Exhaust system	143
Front axle	206
Fuel and air intake system	133
Generating system	157
Ignition system	147
Propeller shafts with universal joints	201
Rear axle	215
Springs and shock absorbers	239
Starting system	154
Steering system	222
Transfer	197
Transmission	192
Wheels and tires	248

## CHAPTER 2

### OPERATING INSTRUCTIONS

---

#### Section I. SERVICE UPON RECEIPT OF MATERIEL

#### 8. Purpose

a. When a new or reconditioned vehicle is received by the using organization, it is necessary for the organizational mechanics to determine whether the vehicle has been properly prepared for service by the supplying organization and is in condition to perform any mission to which it may be assigned when placed in service. For this purpose, inspect all assemblies, subassemblies, and accessories to be sure they are properly assembled, secured, clean, and correctly adjusted and/or lubricated. Check all tools and equipment (pars. 65-68) to be sure every item is present, in good condition, clean, and properly mounted or stowed.

b. In addition, perform a "break-in" of a least 500 miles on all new or reconditioned vehicles and a sufficient number of miles on used vehicles to completely check their operation (par. 10).

c. Whenever practicable, the vehicle driver will assist in the performance of these services.

#### 9. Preliminary Services

a. *General Inspection and Servicing Procedures.*

- (1) Uncrate vehicle, if crated. Remove metal strapping, plywood, tape, seals, wrapping paper, and dehydrant bags. If exterior surfaces are coated with rust-preventive compound, remove it with dry-cleaning solvent or volatile mineral spirits.
- (2) Read Preparation Record for Storage or Shipment tag and follow all precautions checked thereon. This tag should be in the driver's compartment attached to the steering wheel or steering levers or to the switch.
- (3) Using a suitable socket wrench and extension, crank engine by hand, at least two revolutions, before turning ignition on, to test for hydrostatic lock. (This precaution is taken because there might be an excess of preservative oil in the

combustion chambers or, possibly, coolant may have leaked into them.)

*Note.* If the vehicle has been driven to the using organization, most or all of the foregoing procedures should have already been performed.

- (4) Follow the general procedures given in paragraph 76*b*. These procedures apply to both first and second echelon preventive maintenance services and to all inspections and are just as important as the specific procedures.

*b. Specific Procedures.* Perform the semiannual mileage D (6-month or 6,000-mile) preventive maintenance services (par. 79), with the following variations:

- (1) Line out the other services on the work sheet (DA Form 461) and write in "New (or Rebuilt) Vehicle Reception."
- (2) Before starting engine, tighten cylinder-head nuts with a torque-indicating wrench to 65-75 foot-pounds torque and in the sequence prescribed in figure 48.
- (3) Perform item 27 before starting the road test. If a processing tag (*a*(2) above) on the engine or vehicle states that the engine contains preservative oil that is suitable for 500 miles of operation, and of the correct seasonal viscosity, check the level but do not change the oil; otherwise change the oil. Lubricate all points, regardless of interval, except as noted in (6) below. Check the levels of the lubricant in all gear cases. If the gear lubricant is known to be of the correct seasonal grade, do not change it; otherwise change it.
- (4) When the engine has been thoroughly warmed up to operating temperature, recheck the tightness of the cylinder-head nuts with a torque-indicating wrench to 65-75 foot-pounds torque in the sequence shown in figure 48.
- (5) Perform item 35. Inspect breaker points, dressing should not be necessary.
- (6) Perform item 39. Look at wheel bearings. If lubrication appears to be adequate, do not clean and repack. Do not adjust brakes unless necessary.

## 10. Break-In

*a. Operating Vehicle.* Refer to paragraph 41 through 52 for operation under usual conditions. After the preliminary service has been performed (par. 9), the break-in period (500 miles) may be accomplished in normal service of the vehicle under the supervision of a competent driver. The driver will be cautioned against excessive speeds, skipping speeds in shifting gears, rapid acceleration, or in any way loading the engine or power train to capacity during the break-in period. If the vehicle was driven to the using organization, consider the mileage so traveled as break-in mileage.

*b. Service After 500 Miles.* After 500 miles of vehicle operation, perform the mileage "C" (1,000 mile) preventive maintenance service (par. 79), with the following variations:

- (1) Line out the other services on the work sheet (DA Form 461) and write in "New (or Rebuilt) Vehicle 500-Mile Service."
- (2) Change the engine oil.

*c. Service After 1,000 Miles.* When the vehicle has been driven 1,000 miles, it will be placed on the regular preventive maintenance schedule and will be given the first regular mileage "C" (1,000 mile) preventive maintenance service (par. 79).

## **11. Correction of Deficiencies**

*a.* Ordinary deficiencies disclosed during the preliminary inspection and servicing or during the break-in period will be corrected by the using organization or a higher maintenance echelon.

*b.* Serious deficiencies, which appear to involve unsatisfactory design or material, will be reported on DA Form 468. The commander of the using organization will submit the completed form to the Chief of Ordnance, Washington 25, D. C., ATTN: ORDFM.

## **Section II. CONTROLS AND INSTRUMENTS**

### **12. General**

*a.* This section describes, locates, and illustrates, the various controls and instruments provided for the proper operation of the vehicle.

*b.* All pedal and hand lever controls, instruments, gages, and switches are grouped in the driver's compartment (figs. 11 and 13) and are readily accessible to the driver for the operation of the vehicle. The major graduations, letters, figures, and pointer tips on all instruments and gages grouped in the instrument cluster (J, fig. 11) are coated with luminous paint for visibility during night operation.

### **13. Steering Wheel**

The steering wheel (D, fig. 11 and A, fig. 13), located on the left side of the driver's compartment, turns the front wheels and thereby steers the vehicle. Turn the steering wheel clockwise for a right turn and counterclockwise for a left turn.

### **14. Service Brake Pedal**

The service brake pedal (BB, fig. 11 and N, fig. 13) located on the upper-front floor pan cover to the right of the steering gear jacket and is accessible to the driver's right foot. This pedal controls the hydraulic service brakes on all four wheels. Depress the service brake pedal to apply the brakes. The degree of brake application is dependent upon the amount of physical effort applied to the brake pedal. Release the pedal to release the brakes.

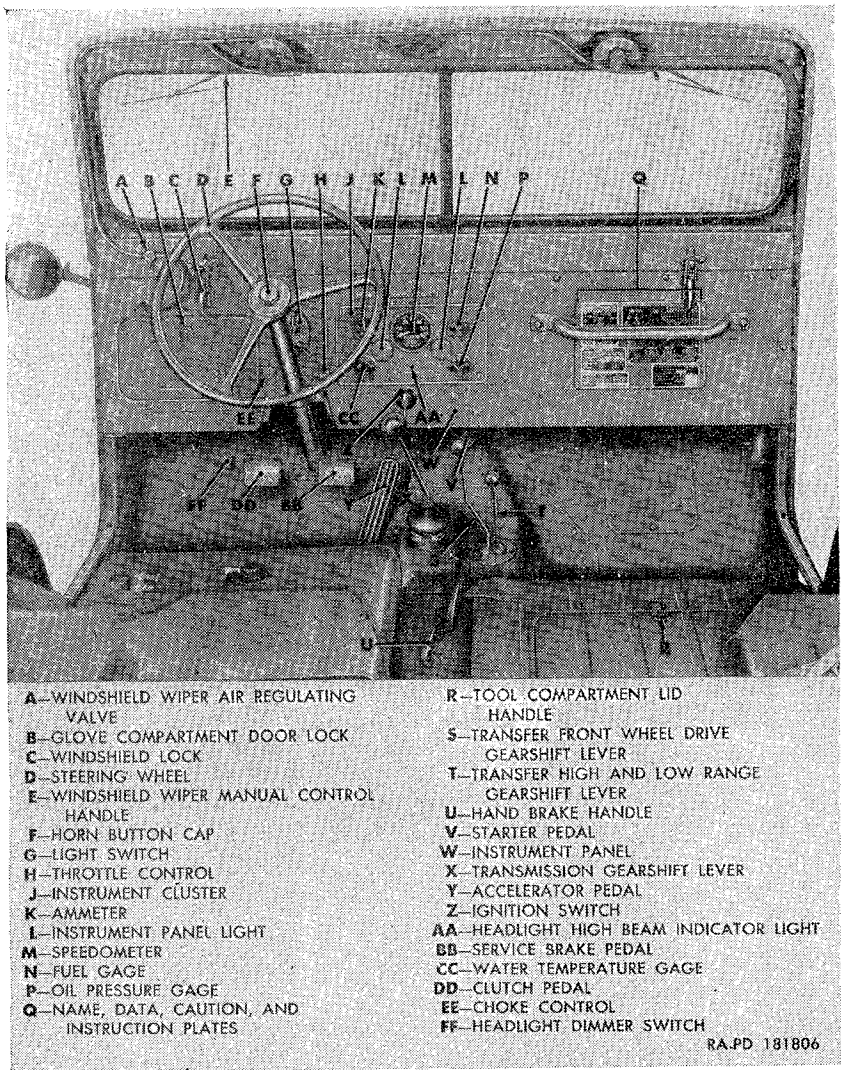

Figure 11. Driver's compartment (M38A1)—rear view—seat removed.

## 15. Clutch Pedal

The clutch pedal (DD, fig. 11 and P, fig. 13) is located on the upper-front floor pan cover at the left of the steering gear jacket and is accessible to the driver's left foot. This pedal functions to engage and disengage the clutch with and from the engine flywheel thereby connecting and disconnecting the transmission with and from the engine. Depress the pedal to disengage the clutch. Release the pedal to engage the clutch.

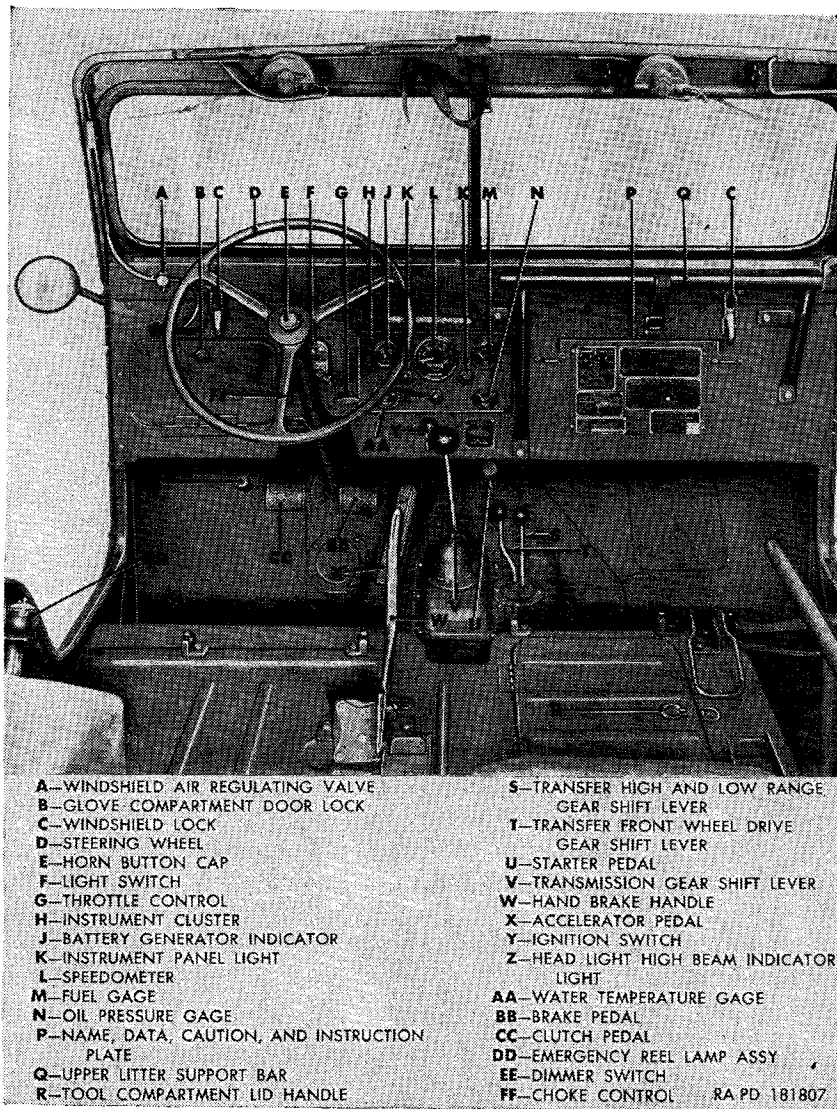

Figure 12. Driver's compartment (M170)—rear view—seat removed.

## 16. Accelerator Pedal

The accelerator pedal (Y, fig. 11 and K, fig. 13) located on the lower-front floor pan cover to the right of the brake pedal, is connected to the carburetor throttle controls and governs the engine speed from idling to full speed in varying degrees dependent upon foot pressure applied. Depress the pedal to increase engine speed. Release the pedal to decrease engine speed. The pedal, when released, will automatically return the engine to the set idling speed.

## 17. Starter Pedal

The starter pedal (V, fig. 11), attached to the upper-front floor pan cover at the right of the accelerator pedal, is a foot-operated control which actuates the starter switch on the starter, causing the starter to become engaged with the engine flywheel, thus cranking the engine. Depress the starter pedal to crank the engine. The pedal, when released, returns automatically to the normal position.

## 18. Transmission Gearshift Lever

The transmission gearshift lever (X, fig. 11 and R, fig. 13) is located in the transmission control lever cover and extends upward into the driver's compartment. This manually operated lever, accessible to the driver's right hand, may be shifted from neutral position to place the transmission in first, second, third or reverse speeds as indicated on the shifting instruction plate (fig. 6). Operation of the transmission gearshift lever is described in paragraphs 43 and 45.

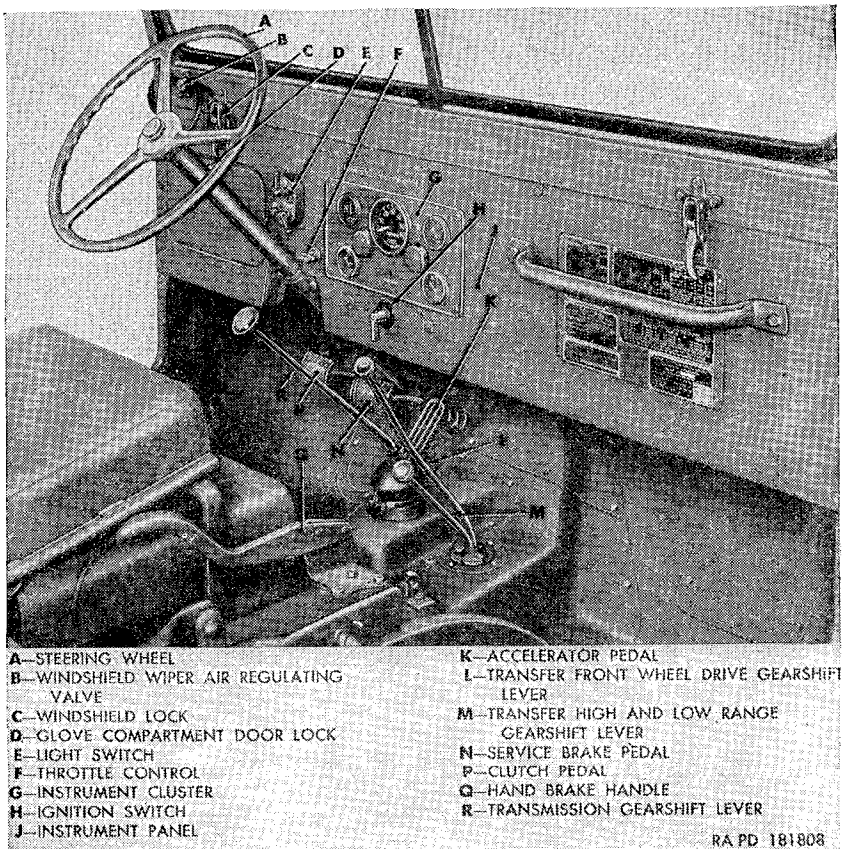

Figure 13. Driver's compartment (M38A1)—right view.



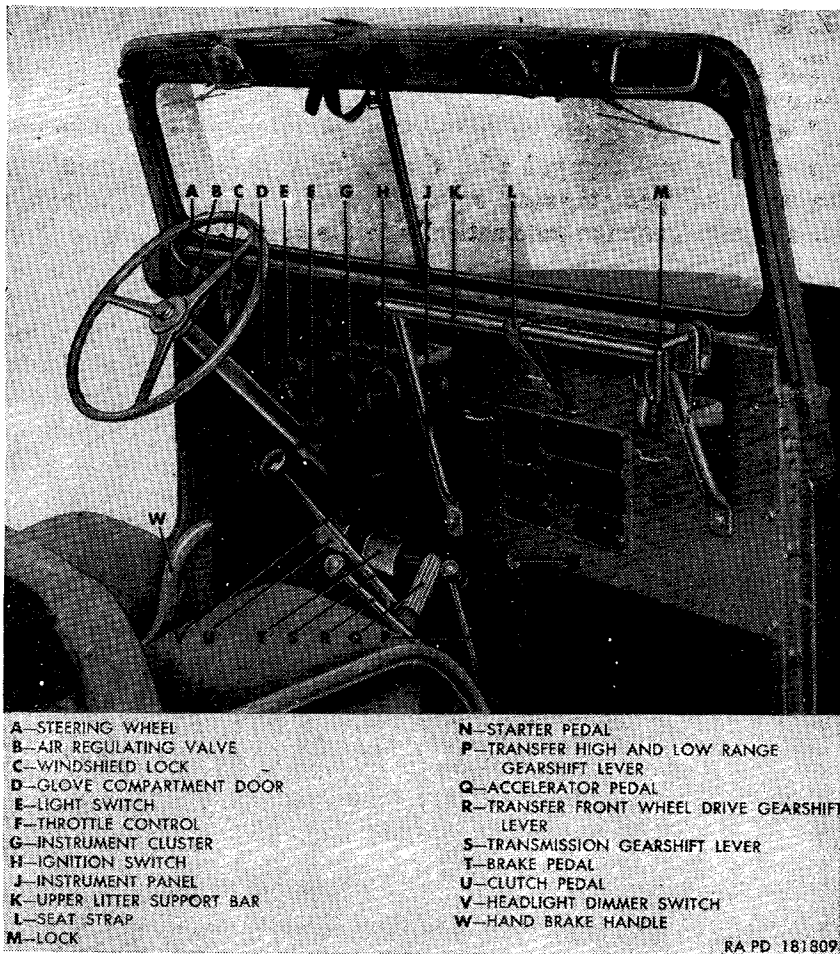

Figure 14. Driver's compartment (M170)—right view.

## 19. Transfer Gearshift Levers

*a. Front Wheel Drive.* The transfer front wheel drive gearshift lever (S, fig. 11 and L, fig. 13), located in the driver's compartment immediately to the right of the transmission gearshift lever, controls the front axle drive selection. Shifting positions for this lever are illustrated on the shifting instruction plate (fig. 6). Operation of the lever is covered in paragraphs 43 and 46.

*b. High and Low Range.* The transfer high and low range gearshift lever (T, fig. 11 and M, fig. 13), located in the driver's compartment at the right of the transfer front wheel drive gearshift lever, provides for manual selection of auxiliary speed ranges in the transfer. This lever may be positioned in any one of three positions (low range, neutral range, and high range) depending upon operating conditions.

Shifting positions of the lever are indicated on the shifting instruction plate (fig. 6). Paragraphs 43 and 46 describe the operation of the lever.

## **20. Hand Brake Handle**

The hand brake handle (U, fig. 11 and W, fig. 12), located at the right of the driver's seat, actuates the mechanical hand brake mechanism mounted on the transfer. To set the hand brake, pull on the hand brake handle. To release the hand brake, press the release lever on the underside of the handle and permit handle to return to the released position. A ratchet mechanism within the handle will hold the hand brake applied until released by pressing the release lever.

## **21. Throttle Control**

The throttle control (H, fig. 11 and F, fig. 13), located at the lower edge of the instrument panel at the right of the steering gear jacket, provides a hand-operated control of engine speeds. It is primarily used to set the carburetor throttle at the desired starting and warmup speed. To accelerate engine, pull throttle control out to desired position. To return engine to its set idling speed, turn control 90° or more to the right or left and push control in against instrument panel. A ratchet arrangement is incorporated in the control to hold it in the desired pulled-out position. Control must be positioned so the imprinted THROTTLE is right side up before ratchet will engage.

## **22. Choke Control**

The choke control (EE, fig. 11) is located at the lower edge of the instrument panel at the left of the steering gear jacket. This control is connected to the lever of the carburetor choke valve shaft with lever assembly which closes in proportion to the degree the choke control is pulled out. The control is used when starting and operating a cold engine. Pull the control out from instrument panel as desired when starting a cold engine. Push control all the way in against instrument panel after engine is started and operating correctly.

## **23. Ignition Switch**

The lever-type ignition switch (Z, fig. 11 and H, fig. 13) is mounted on the instrument panel, directly below the instrument cluster. To turn the ignition circuit on, turn the lower end of the switch lever to the left (counterclockwise) until opposite end of lever is alined with the ON position imprinted on the ignition switch instruction plate (fig. 9). When ignition circuit is on, all the electrical gages in the instrument cluster will become energized, permitting reading of their values. To turn the ignition circuit off, turn lower end of switch lever to the right (clockwise) until opposite end of lever is alined with the OFF position imprinted on instruction plate.

## 24. Light Switch

(fig. 15)

*a. General.* The light switch (E, fig. 13), located on the instrument panel directly in front of the steering gear jacket, is a three lever-type with main switch, auxiliary switch, and mechanical switch levers. The light switch controls all the lights on the vehicle.

- (1) *Main switch lever.* The five-position main switch lever, located at the top of the light switch with the switch lever pointing up, can be positioned to energize the circuit to all the vehicle lights including the instrument panel and parking lights.

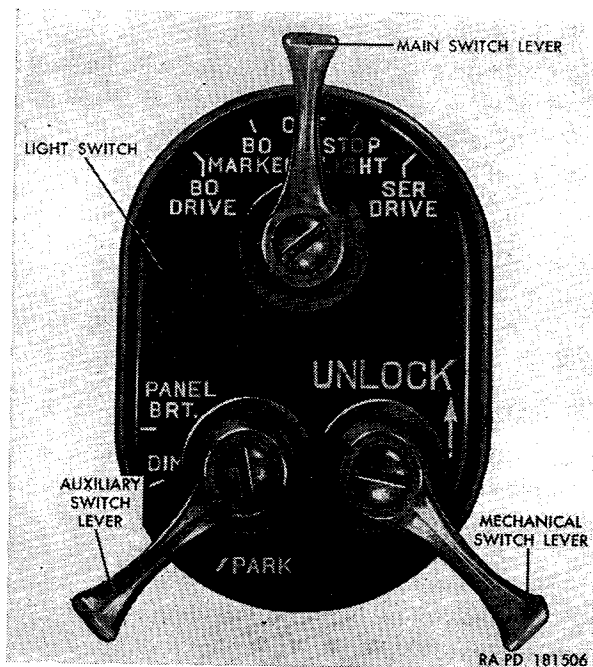

Figure 15. Light switch—levers in off positions.

- (2) *Auxiliary switch lever.* The auxiliary switch lever, located at the left and below the main switch lever, controls the instrument panel and the parking lights. It is inoperative when the main switch lever is in OFF position.
- (3) *Mechanical switch lever.* The mechanical switch lever, located below and to the right of the main switch lever, locks the main switch lever to prevent accidentally turning on the STOPLIGHT, SER DRIVE and BO DRIVE circuits. This lever must be held in the UNLOCK position before the main switch lever can be moved to STOPLIGHT, SER DRIVE, and from BO MARKER to BO DRIVE.

*b. Operation.*

- (1) *OFF position.* Turn the main switch lever to the OFF position to turn off all the vehicle lights. Switch lever can be moved from any position to OFF without placing mechanical switch lever in UNLOCK position.
- (2) *Blackout marker position.* Turn the main switch lever to the left to the BO MARKER position to turn on the signal marker and service parking lights, and energize the circuit for the blackout tail and stoplight and the blackout light of the service tail and stoplight. If instrument panel lights are desired, turn the auxiliary switch lever to either the DIM, PANEL BRT, or PARK position.
- (3) *Blackout drive position.* Hold the mechanical switch lever up in the UNLOCK position. Turn the main switch lever to the left to the BO DRIVE position to turn on the blackout driving light, signal blackout marker and service parking lights, the blackout taillight of the service tail and stoplight, and the blackout taillight of the blackout tail and stoplight. If instrument panel lights are desired, turn the auxiliary switch lever to either the DIM, PANEL BRT or PARK position.
- (4) *Stoplight position.* Hold the mechanical switch lever up in the UNLOCK position. Turn the main switch lever to the right to the STOPLIGHT position to energize the service tail and stoplight circuit for daylight hours. In the STOPLIGHT position, no other light circuits besides the service tail and stop, and the instrument panel are energized.
- (5) *Service drive position.* Hold the mechanical switch lever up in the UNLOCK position. Move the main switch lever to the right to the SER DRIVE position to turn on the headlights and the service tail and stoplight. Move the auxiliary switch lever to DIM or PANEL BRT for instrument panel lights, if desired.
- (6) *Parking position.* With the main switch lever in the SER DRIVE position, turn the auxiliary switch lever to the right to the PARK position to turn on the dim instrument panel lights and the service tail and stoplight.

## **25. Headlight Dimmer Switch**

The headlight dimmer switch (FF, fig. 11) is located to the left of the clutch pedal. This foot-operated switch, accessible to the driver's left foot, is used to control the high and low beams of the headlights. With bright lights on (high beam), depress the dimmer switch to change to low beam and dim lights. To switch to bright lights, de-

press the dimmer switch. The headlight high beam indicator light (AA, fig. 11) indicates when high beam or bright lights are on.

## **26. Windshield Locks**

Two windshield locks (C, figs. 11 and 13) are provided on the windshield assembly to hold it in the vertical position. To disengage windshield locks from the windshield locking clamp catches on the instrument panel, pull locks out at the bottoms. To engage windshield locks, position locks over the windshield locking clamp catches and push bottoms of locks toward instrument panel. Lowering and raising of the windshield assembly is described in paragraph 254.

## **27. Glove Compartment Door Lock**

The glove compartment door lock (B, fig. 11 and D, fig. 13) is located on the top of the glove compartment door on the extreme left of the instrument panel. To open glove compartment door, press button in center of the lock and pull door open. To close the glove compartment door, swing the door up against instrument panel. The lock will automatically latch when door is closed.

## **28. Tool Compartment Lid Handle**

The tool compartment is located under the front passenger seat on the right side of the driver's compartment and provides for vehicular tool stowage. To gain access to tool compartment, swing front passenger seat up and forward. To open tool compartment lid, turn the tool compartment lid handle (R, fig. 11) 90° and pull upward. To close tool compartment lid, lower lid making sure handle is turned 90° to clear flange of tool compartment, and lock the lid by turning handle 90° toward front of vehicle.

## **29. Medical Supplies Stowage Compartments Handles (M170)**

Two compartments, one in each rear wheel house, provide for medical supply stowage. To gain access to the stowage compartments, lift the front cushion of the left-rear passenger seat and the rear cushion of the right-rear passenger seat. To open the compartment lid, turn the medical supplies stowage compartment lid handle 90° and pull upward. To close the lid, lower lid making sure handle is turned to clear the compartment flange, and lock the lid by turning the handle 90°.

## **30. Windshield Wiper Air Regulating Valve**

The windshield wiper air regulating valve (A, fig. 11 and B, fig. 13) is located on the windshield assembly at the left of the steering wheel. This valve controls the operation of the windshield wiper motors. To turn the motors on, turn the valve lever counterclockwise. To turn the motors off, turn the valve lever clockwise.

### **31. Windshield Wiper Manual Control Handles**

A windshield wiper manual control handle (E, fig. 11) is mounted on each windshield wiper motor for manual operation of the windshield wiper blade. To operate blade, move handle back and forth as necessary.

### **32. Horn Button Cap**

The horn button cap (F, fig. 11) is located in the center of the steering wheel. Depress cap to sound the horn. Release cap pressure to stop sounding of horn.

### **33. Ammeter (M38A1) and Battery Generator Indicator (M170)**

The ammeter (M38A1) (K, fig. 11) and the battery generator indicator (M170) (J, fig. 12) are located in the upper-left corner of the instrument cluster. The ammeter indicates the amount of current flowing to and from the batteries, depending upon whether the battery is being charged or discharged. The ammeter dial (M38A1) is calibrated to register from DIS to CHG, with zero at the midfront of the needle swing. The battery generator indicator (M170) is a combination voltmeter and ammeter. When the ignition switch is turned on, before the engine is started, the position of the needle indicates the voltage available in the battery: red, low voltage; yellow, normal voltage; and green, high voltage. After the engine is started, the indicator functions as an ammeter. The ammeter will generally show a charge when the engine is first started and continue to show a charge as engine speed is increased, depending upon the amount of electrical power being used. Abnormal readings (par. 86), when engine is operating at normal speed, indicates an inoperative generating system. If improper operation of generating system is indicated by ammeter, stop engine and investigate cause (par. 90a).

### **34. Fuel Gage**

The fuel gage (N, fig. 11), located in the upper right corner of the instrument cluster, indicates the amount of fuel in the fuel tank. The gage dial is marked with E,  $\frac{1}{4}$ ,  $\frac{1}{2}$ ,  $\frac{3}{4}$  and F. The fuel gage functions only when the ignition switch is on. If gage is inoperative, refer to paragraph 90b.

### **35. Oil Pressure Gage**

The oil pressure gage (P, fig. 11), located in the lower right corner of the instrument cluster, indicates the engine oil pressure when the engine is running.

*Note.* Engine oil pressure does not indicate amount of oil in the engine crankcase.

The gage dial is marked from 0 to 120 psi in graduations of 30 psi. Oil pressure under normal operating conditions is 30 to 35 psi and

approximately 10 psi when engine is idling. Absence of oil pressure when engine is running indicates a faulty engine lubrication system or an inoperative gage circuit. If improper operation of lubrication system or gage circuit is indicated, stop engine immediately and investigate cause (pars. 81*i* and 90*d*).

*Note.* When engine is started cold, oil pressure may indicate slightly high but, under normal condition, will return to normal reading (30 to 35 psi) after engine has warmed up.

### **36. Water Temperature Gage**

The water temperature gage (CC, fig. 11) is located in the lower left corner of the instrument cluster. The gage dial is marked from 60° to 260° F. This gage, which is actuated by the engine water temperature sending unit mounted on the engine, indicates the engine coolant temperature. Normal operating temperature is 160° to 180° F. If temperature rises suddenly during warmup or normal operation, stop engine and investigate cause (par. 88). Temperature below 140° F., during normal operation indicates an inoperative cooling system. If temperature is below 140° F., stop engine and investigate cause (par. 88). For inoperative gage, refer to paragraph 90*c*.

### **37. Instrument Panel Lights**

Two instrument panel lights (L, fig. 11) are located on the instrument cluster below, and one to either side of the speedometer. These lights provide illumination for the instruments and gages during night operation. The auxiliary switch lever on the light switch (fig. 15) actuates these lights and permits them to be turned off, on dim, or on bright. Metal shields over the panel light lamps prevent reflection during night operation.

### **38. Headlight High Beam Indicator Light**

The headlight high beam indicator light (AA, fig. 11), located on the instrument cluster below the speedometer, indicates when the high beam of the headlights is on. This light will go out when headlights are returned to low beam by operation of the headlight dimmer switch (par. 25).

### **39. Speedometer**

The speedometer (M, fig. 11), located in the center of the instrument cluster, indicates vehicle speeds in miles per hour and records the total mileage (on odometer) the vehicle has been driven. The speedometer face is graduated from 0 to 60 in units of 1 mph and the odometer is calibrated from 0 to 99,999 miles.

## 40. Emergency Reel Lamp Switch (M170)

The emergency reel lamp switch (fig. 109) is located in the lamp handle. Current is supplied to the switch only when one of the light switch levers (fig. 15) is in any position except OFF. The lamp unit is protected by an adjustable cover that can be partially closed for blackout use.

### Section III. OPERATION UNDER USUAL CONDITIONS

#### 41. General

This section contains instructions for the mechanical steps necessary to operate the  $\frac{1}{4}$ -ton 4 x 4 utility truck M38A1 and the  $\frac{1}{4}$ -ton 4 x 4 front line ambulance M170 under conditions of moderate temperature and humidity. For operation under unusual conditions, refer to section V, this chapter.

#### 42. Starting the Engine

a. The driver must become familiar with the purpose and location of the various controls and instruments described in section II (pars. 12 through 38) before he makes any attempt to start the engine. In conjunction with starting and warming up the engine, the driver must perform the prescribed before-operation services listed in table II.

b. Position the transmission gearshift lever (X, fig. 11 and R, fig. 13) in the NEUTRAL position indicated on the shifting instruction plate (fig. 6).

c. If the vehicle is being operated at night, turn on the instrument panel lights (par. 24a(1) and (2)).

d. Pull the choke control (EE, fig. 11) all the way out. If engine has been recently operated and is still warm, choking will not be necessary.

e. Turn the ignition switch clockwise to ON position.

f. Depress clutch pedal (DD, fig. 11 and P, fig. 13) to disengage clutch. Hold clutch pedal down until engine is started.

g. Depress starter pedal (V, fig. 11 and U, fig. 12) until starter operates to crank engine. Release pedal as soon as engine starts.

**Caution:** Do not hold starter engaged for periods in excess of 30 seconds to avoid overheating and resultant damage to starter. If starter has been engaged without results, wait for 15 seconds; then crank engine again. If, after several attempts, the engine fails to start, determine the cause (par. 81b).

h. After engine starts, use the throttle control or accelerator pedal to speed up engine if it shows signs of stopping. Release the clutch pedal. Push the choke control in to a point at which engine is running smoothly. As soon as engine is properly warmed up, push choke control all the way in.



i. Check the reading on the oil pressure gage (P, fig. 11). Oil pressure should be 10 psi at idling with engine warm and higher if engine is cold.

*Note.* Stop engine and investigate cause if gage shows no pressure (pars. 81i and 90d).

Check the ammeter (K, fig. 11). Ammeter should show a charge, with lights turned off, when engine is running at a fast idle. If ammeter does not show charge, stop the engine and investigate the cause (par. 90a).

j. Check the reading on the water temperature gage (CC, fig. 11) after the engine has warmed up for several minutes. Normal operating temperatures is between 160° and 180° F. If the engine coolant temperature rises quickly (above 180° F.), or remains below 160° F., stop engine and investigate cause for overheating or undercooling (par. 88). Check reading on fuel gage (N, fig. 11) to see if there is sufficient fuel to perform mission to which vehicle has been assigned.

### **43. Placing the Vehicle in Motion**

a. Place the transfer high and low range gearshift lever (T, fig. 11 and M, fig. 13) in the rear position to engage the transfer HIGH range (par. 46). If the front axle is to be used for four wheel driving, place the transfer front wheel drive gearshift lever (S, fig. 11 and L, fig. 13) in the IN position (to the rear) to engage the front axle (par. 46). If the front axle is to be disengaged, move the transfer front wheel drive gearshift lever to the forward or OUT position.

*Note.* The transfer shifting diagrams are located on the shifting instruction plate (fig. 6) on the instrument panel to aid in gearshift lever selection.

b. Depress clutch pedal (DD, fig. 11) and move the transmission gearshift lever (X, fig. 11) from NEUTRAL position to its extreme limit of travel to the left and pull it to the rear (toward driver) to engage low (1st) gear.

*Note.* The transmission gearshift lever positions are diagrammed on the shifting instruction plate (fig. 6) on the instrument panel.

c. Release the hand brake handle (Q, fig. 13) by pressing release lever and lowering handle to released position.

d. Depress accelerator pedal (Y, fig. 11) slightly to increase engine speed, and, at the same time, slowly release the clutch pedal. As the clutch engages and the vehicle begins to move, gradually increase engine speed by increasing pressure on accelerator pedal.

*Note.* During the next two operations, perform the during-operation services outlined in table II.

e. Increase speed to approximately 10 mph, depress clutch pedal and, at the same time, release the accelerator pedal completely. While clutch pedal is depressed, move transmission gearshift lever up out

of low gear, across NEUTRAL position to its extreme limit of travel to the right, and forward (away from driver) into intermediate (second) gear. No "double clutching" is required in this operation. Release clutch pedal and accelerate engine.

*f.* When vehicle has attained a speed of approximately 20 mph in second gear, depress clutch pedal and release accelerator pedal, and move transmission gearshift lever rearward (toward driver) into third (high) gear position. Release clutch pedal and accelerate engine.

#### **44. Normal Driving**

*a.* The greater part of the normal driving will be on paved or improved roads where it is not necessary to use the front axle. The transmission gearshift lever should be left in third gear unless speed of vehicle reduces to a point where the engine begins to labor. In this case, the vehicle should be placed in a lower gear range until speed again reaches a point where it may be safely shifted into third gear.

*b.* The foot pressure on the accelerator pedal determines the engine and vehicle speed. To slow the vehicle speed where there is no necessity for brakes, release the pressure on the accelerator pedal. It is not necessary to shift the transmission when accelerating from speeds above 28 mph.

*c.* To compensate for hills, shift into a lower gear range. When descending normal hills, release pressure on accelerator pedal.

**Caution:** Never depress clutch pedal or disengage transmission when descending hills.

*d.* When driving on wet or slippery paved roads, gage speed of vehicle accordingly to have maximum control at all times. Avoid turning steering wheel too sharply. Do not negotiate hills or trenches in excess of the limits specified in the tabulated data (par. 7). Do not exceed speeds indicated on the speed caution plate (fig. 6).

#### **45. Shifting Transmission to Lower Gears While in Motion**

*a.* When approaching unusually steep grades or rough terrain, it sometimes becomes necessary to shift the transmission to a lower gear range in order to retain complete vehicle control and keep the vehicle moving.

*b.* When approaching a hill or a stretch of soft terrain, shifting gears to lower speeds may be accomplished without severe clashing or grinding of gears by a "double clutching" method (*c* below). The shift to a lower gear should be made before the engine starts to labor and the vehicle loses momentum.

*c.* To "double clutch," perform the following operations in sequence and as rapidly as possible to avoid unnecessary loss of vehicle speed:

- (1) Depress clutch pedal and quickly move transmission gearshift lever to NEUTRAL position.

- (2) Release clutch pedal and accelerate engine to a speed approximately or slightly more than the speed needed to maintain the same vehicle speed in the lower gear being selected. This action speeds up the transmission drive gear to match the transmission driven gear speed, eliminating gear clash.
- (3) Quickly depress clutch pedal, move transmission gearshift lever from **NEUTRAL** position to the desired (next lower) gear position, release clutch pedal, and depress accelerator pedal to accelerate engine for desired vehicle speed.

*Note.* The engine speed need not be accelerated for the two later operations.

## 46. Shifting Gears in Transfer

*a. General.* The transfer front wheel drive gearshift lever (S, fig. 11) and the transfer high and low range gearshift lever (T, fig. 11) provide for applying power to the front axle as well as the rear. In addition, the low range gear provided by the transfer doubles the number of speed ranges provided by the transmission. The selection of the various gear ratios depends upon the load and road conditions. Shift gears in the transfer in accordance with the instructions on the shifting instruction plate (fig. 6) on the instrument panel, and observe the warnings on the speed caution plate, also on the instrument panel.

**Caution:** Do not shift high and low range gearshift lever from **HIGH** to **LOW** at speeds above 5 mph.

The selection of the transmission gears does not, in any way, affect the selection or shifting procedure of the transfer. The vehicle may be driven by the rear axle alone or by both the front and rear axles.

### *b. Engaging Front Axle.*

- (1) The front axle should be engaged only for off-the-road operation, slippery road, steep grades, or during hard pulling. In ordinary use on average roads and under normal conditions, the front axle should be disengaged. Engagement of the front axle can be made with the vehicle stopped or in motion. The transfer must be in front axle drive for use of transfer **LOW** range.
- (2) To engage the front axle, depress the clutch pedal to facilitate shifting. Pull the transfer front wheel drive gearshift lever (S, fig. 11) to the rear or **IN** position.
- (3) To disengage the front axle, depress clutch pedal to facilitate shifting and push the transfer front wheel drive gearshift lever forward to the **OUT** position.

### *c. Selecting LOW or HIGH Range Speeds.*

- (1) For normal operations, the transfer high and low range gearshift lever (T, fig. 11) should be in the rear or **HIGH** position

(fig. 6). With the lever in this position, the vehicle may be operated in either two or four wheel drive.

- (2) To shift the transfer to LOW range position (when not in four wheel drive), move the transfer front wheel drive gearshift lever to the rear or IN position, move the transfer high and low range gearshift lever forward to the LOW position.

**Caution:** Do not shift high and low range gearshift lever from HIGH to LOW at speeds above 5 mph.

- (3) Whenever possible, halt the vehicle prior to shifting the transfer high and low range gearshift lever from LOW to HIGH range or from HIGH to LOW range. Depress the clutch pedal to facilitate shifting. In some cases, when shifting the transfer gearshift levers, it may be necessary to "double clutch" (par. 45c).

## 47. Stopping the Vehicle

a. When stopping the vehicle, foot should be removed from the accelerator pedal before the anticipated stopping point is reached. Application of the service brake pedal should be made at a distance, in accordance with vehicle speed, to avoid sudden jerking stops which apply sudden loads and strains on the brake system and vehicle.

b. When a stop is anticipated, remove foot from the accelerator pedal and move it to the service brake pedal (BB, fig. 11 and N, fig. 13). Apply brakes by depressing service brake pedal. Apply brakes gently but firmly to avoid skidding tires and bring vehicle to a smooth stop.

c. When stopping vehicle on ice or slippery terrain, the brakes should be applied in a series of quick applications and releases, to increase traction qualities. Holding brakes applied on ice or slippery terrain will cause wheels to skid.

d. When stopping a vehicle with a towed load, such as a trailer, the weight of the towed load should be considered and used to determine the distance needed for stopping. Stops should be made as easily and smoothly as possible to prevent "jack-knifing" the trailer with resultant damage to vehicle or trailer. If trailer is equipped with brakes which has controls installed in the vehicle, trailer brakes should be applied first to prevent "jack-knifing" before vehicle brakes are applied.

e. When vehicle speed has been reduced, and engine has returned to near idling speed, depress clutch pedal, stop vehicle, and move the transmission gearshift lever to the NEUTRAL position (fig. 6).

f. When vehicle is stopped completely, apply the hand brake handle with sufficient force to hold vehicle, and release the clutch and brake pedals.

## 48. Parking the Vehicle

*a.* When parking the vehicle, make sure all switches are in the OFF position unless the tactical situation requires otherwise.

*b.* When parking on a hill or grade, make sure hand brake is applied and, if grade is extremely steep, chock the front or rear wheels to prevent accidental movement of vehicle.

*c.* Avoid parking vehicle in mud or water, if possible, to prevent damage to tires if freezing occurs.

*d.* If parking in formation or line, leave ample space between vehicles to avoid bumping, with resultant vehicle damage.

## 49. Reversing the Vehicle

*a.* Before attempting to reverse the vehicle, bring it to a complete stop and make sure the area behind is clear. If vision to the rear is obscured, station someone outside to direct the reversing operation.

*b.* Allow engine to return to idle speed. Depress clutch pedal, and move the transmission gearshift lever through the NEUTRAL position (if in second or third gear position) to its extreme limit of travel to the left and then push it forward (away from driver) to the REVERSE position (fig. 6). If the gearshift lever is in first gear position prior to stopping, move the lever straight forward to the reverse position.

*c.* Release the clutch pedal slowly and, at the same time, depress the accelerator pedal. Accelerate engine to move the vehicle at desired speed.

**Caution:** Do not attempt to drive vehicle at excessive speeds in reverse gear as control is easily lost.

## 50. Stopping the Engine

After the vehicle is at a complete stop (par. 47) turn the ignition switch (H, fig. 13) counterclockwise to the OFF position. At the end of the day's operations, perform the after-operation services outlined in table II.

## 51. Use of Lights

*a. General.* The type of lights used on the mission to which the vehicle has been assigned depends upon the tactical situation. Use of the light switch (E, fig. 13) is described in paragraph 24. Operation of the headlight dimmer switch (FF, fig. 11) for controlling the high and low beams of the headlights is described in paragraph 25.

*b. Trailer Coupling Electrical Connector Receptacle (M38A1)* (fig. 16). The trailer coupling electrical connector receptacle is located at the left rear corner of the body and the wiring is interconnected with the vehicle light switch. The light switch positions control the tail-lights on the trailer in the same manner as controlled on the vehicle

(par. 24). To connect the trailer coupling cable into the receptacle, lift up the receptacle cover and plug cable into receptacle. A clip on the cover holds the cable in place in the receptacle.

c. *Emergency Reel Lamp Assembly (M170)* (fig. 109). The emergency reel lamp, located at the left rear of the driver's seat, is interconnected with the light switch. Electrical current is available at the lamp whenever any of the vehicle lights are turned on. A switch in the handle controls the lamp. Pull the switch back to turn the lamp on and forward to turn it off. The adjustable lamp cover should be kept closed to protect the lamp unit when the light is not in use.

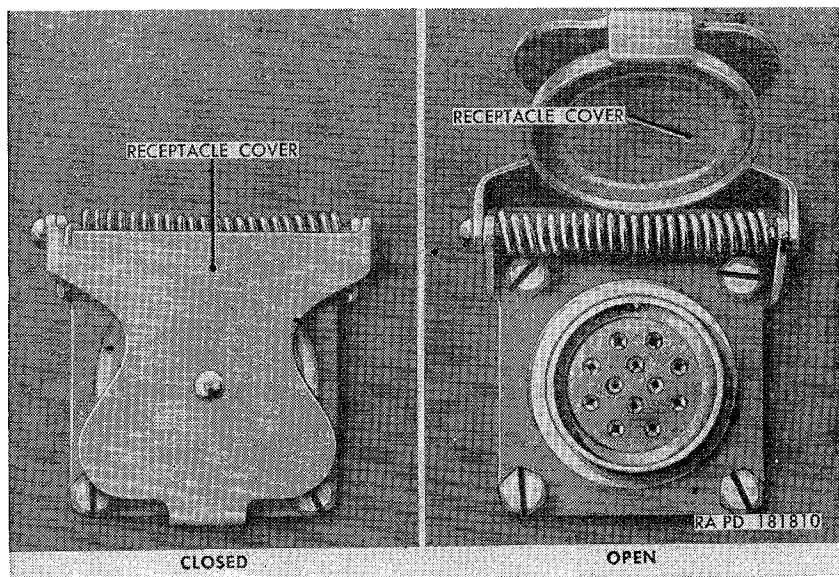

Figure 16. Trailer coupling electrical receptacle (M38A1).

## 52. Towing the Vehicle

a. *General.* The vehicle is equipped with two front and two rear lifting shackles and a towing pintle (fig. 17). The pintle is located at the rear of the vehicle and is the prime means of attaching a trailer, towing cable, or towing bar. To open pintle, pull the towing pintle latch to the rear, and, at the same time, pull up on the towing pintle lock. To close pintle, push down on lock.

b. *Towing to Start Engine.* In case of emergency, the engine can be started either by pushing or towing the vehicle; however, succeeding instructions must be carefully followed to avoid damage to transmission.

- (1) Connect the to-be-towed and towing vehicles by a suitable cable, chain, rope, or towing bar of sufficient length to permit maneuverability of both vehicles.

- (2) Place the transfer high and low range gearshift lever of towed vehicle in **HIGH** gear range position. Place the transfer front wheel drive gearshift lever in the **OUT** position.
- (3) Depress the clutch pedal and place the transmission gearshift lever in third (**HIGH**) gear.
- (4) Turn ignition switch to **ON** position. Pull out choke control if engine is cold. Release the hand brake handle.
- (5) Move towing vehicle slowly until all slack is taken up in towing line between towed and towing vehicle; then tow vehicle.
- (6) After towed vehicle is under way, release clutch pedal slowly and depress accelerator pedal slightly. As engine starts,

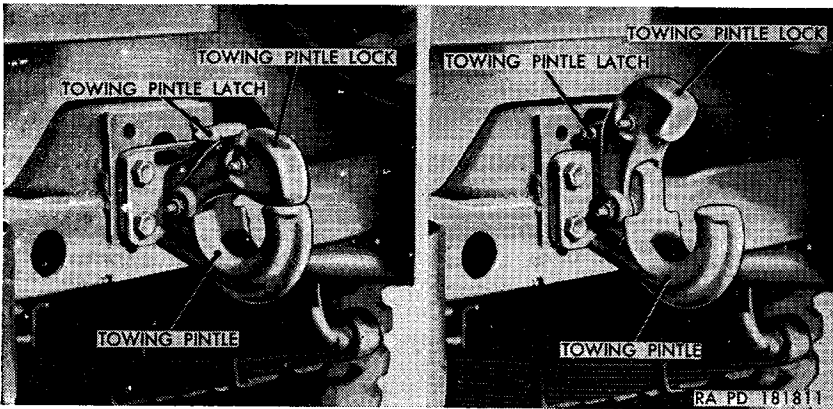

Figure 17. Towing pintle operating positions.

depress clutch pedal and move transmission gearshift lever to **NEUTRAL** position. Adjust choke and throttle controls accordingly as engine warms up.

**Caution:** Take care not to overrun the towing vehicle or towing line.

*c. Towing a Disabled Vehicle.* When towing a disabled vehicle, be careful to avoid damage to either vehicle.

- (1) *Towing vehicle with all four wheels on the ground.*
  - (a) If transfer is not damaged, shift the transmission and transfer into **NEUTRAL** positions and proceed as instructed in (c) and (d) below.
  - (b) If transfer is damaged, disconnect both the front and rear propeller shafts (figs. 129 and 130) (pars. 202a and 203a) at the axle flanges, being careful not to lose any parts. Securely fasten propeller shaft to frame with wire.
  - (c) If the front axle differential or propeller shaft is damaged, remove the front axle drive shaft flanges (**E**, fig. 134).

Place the front wheel drive gearshift lever in the OUT position (fig. 6). Vehicle can be driven under its own power through the rear axle.

- (d) If the rear axle differential or propeller shaft is damaged, remove the rear propeller shaft (par. 203a). Place the front wheel drive gearshift lever in IN position (fig. 6). This will allow the vehicle to be driven under its own power through the front driving axle.
- (e) If the disabled vehicle has faulty brakes, do not attempt to tow it with cable, rope, or chain. A towing bar must be used to prevent the towed vehicle overrunning the towing vehicle. When towing, always use the lifting shackles or towing pintle.
- (2) *Towing vehicle with front or rear wheels off ground.* If vehicle is damaged to the extent that towing must be accomplished with either the front or rear wheels off the ground, make sure the transmission gearshift lever and the transfer high and low range gearshift lever are in NEUTRAL positions, and that the transfer front wheel gearshift lever is in the OUT position.

## **Section IV. OPERATION OF AMBULANCE EQUIPMENT**

### **53. General**

The use and stowage of special ambulance equipment is described in this section. Litter racks, seats and crash pads, the tailgate, and curtains can be placed in different positions depending upon the way the vehicle is to be used.

### **54. Litter Racks**

*a. General.* The lower litter rack (fig. 18) is secured to the floor on the right side of the body. The upper litter rack (fig. 18), a removable folding-type, is suspended by a hanger, supports, and retainers above the right wheel house. An auxiliary litter may be mounted above the left wheel house if desired. This auxiliary litter is mounted by supports (fig. 19) on the driver's seat, left wheel house, and tailgate. Two rear holddown straps are provided to tie down the rear of the auxiliary litter.

*b. Lowering Upper Litter Rack.* Withdraw the rear-outer locking pin (fig. 18) from the retainer on the upper litter rack and the support on the right-rear side top bow. Lift the upper litter rack hanger off the center-rear top bow and push hanger forward until it is engaged in the litter hanger rod stowage and stop clip (fig. 20). Slide the rack toward the center of the vehicle until the rack clears the support on the right-rear side top bow. Lower the rack until the rear end rests on top of the tailgate.



c. *Raising Upper Litter Rack.* Lift the rear end of the rack from its lowered position on the tailgate (fig. 20) to horizontal position. Move the rack to the right until it rests on the support on the right-rear side top bow. Pull the hanger rod free of the litter hanger rod stowage and stop clip and hook the upper end of the hanger rod on the center-rear top bow. Lock the rack to the support on the right-

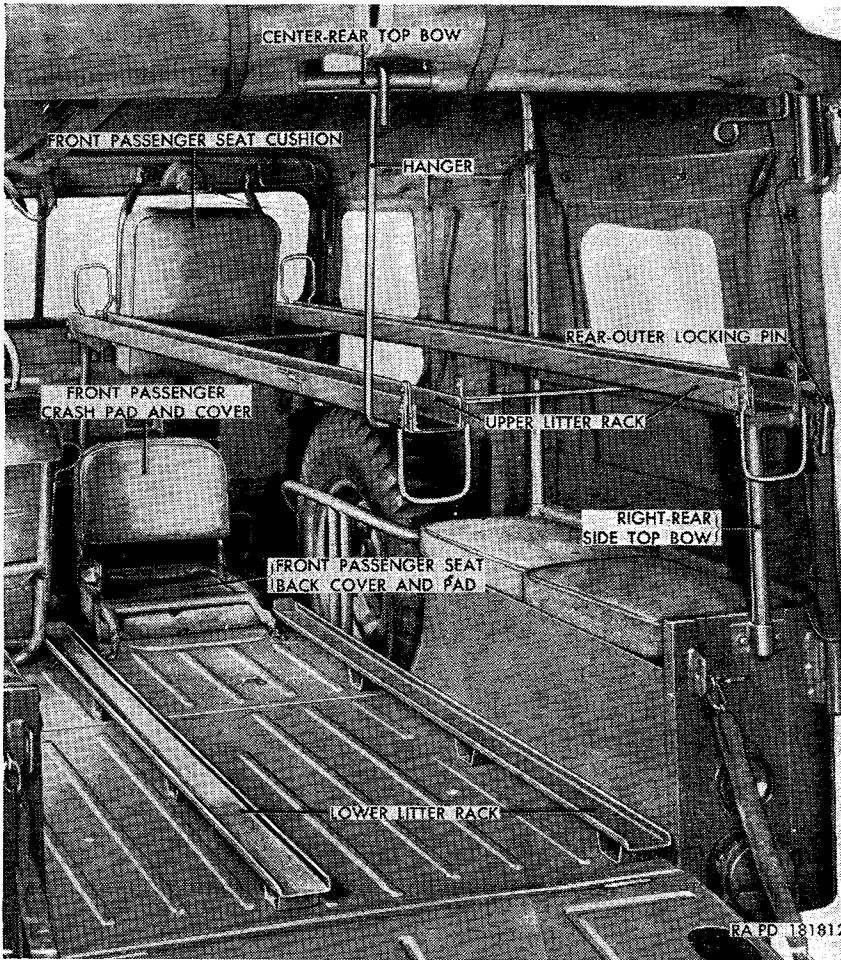

Figure 18. Lower and upper litter racks (M170)—installed.

rear side top bow by inserting the upper litter rack rear-outer locking pin (fig. 18) through the retainer holes on the rack and the support holes of the bow.

d. *Stowing the Upper Litter Rack.* Lift the upper litter rack hanger off the center-rear top bow and push hanger forward until it is engaged in the litter hanger rod stowage and stop clip (fig. 21). Fold the rear

spreader arm of the upper litter rack to the rear and the front spreader arm to the front. Slide the litter rack inner rail toward the outside until the inner rail is against the outer rail. Turn the locking pin securing the inner rail to the upper litter rack support on the instrument panel a quarter turn and withdraw the pin. Swing the rack up and to the outside until the rack is against the sides of the top bows. Wrap the stowage strap, located on the outside bow, around the litter rack twice and fasten the strap.

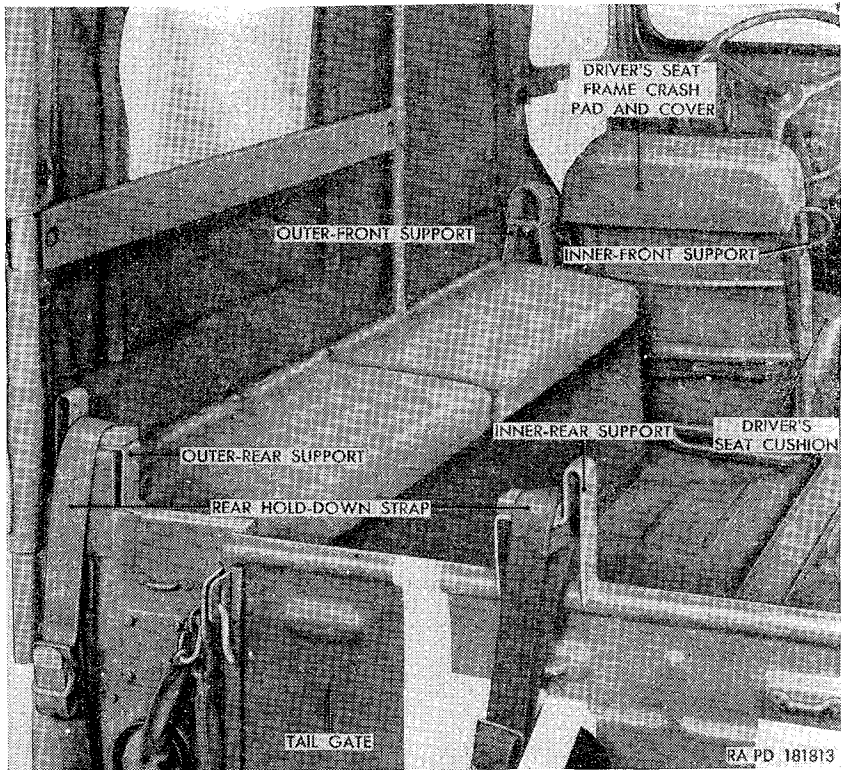

Figure 19. Auxiliary litter supports (M170).

## 55. Seats and Crash Pads

*a. General.* The vehicle is equipped with a driver's seat, a front passenger seat, and four wheel house cushions that serve as seats for rear passengers. The rear of the driver's seat is equipped with the driver's seat frame crash pad and cover (fig. 19) for the patient's head protection when the auxiliary litter is being used. The driver's seat back can be folded forward to provide accessibility to the patients from the left side of the vehicle. The front passenger seat is so designed that it can be used either as a passenger seat or in crash pad

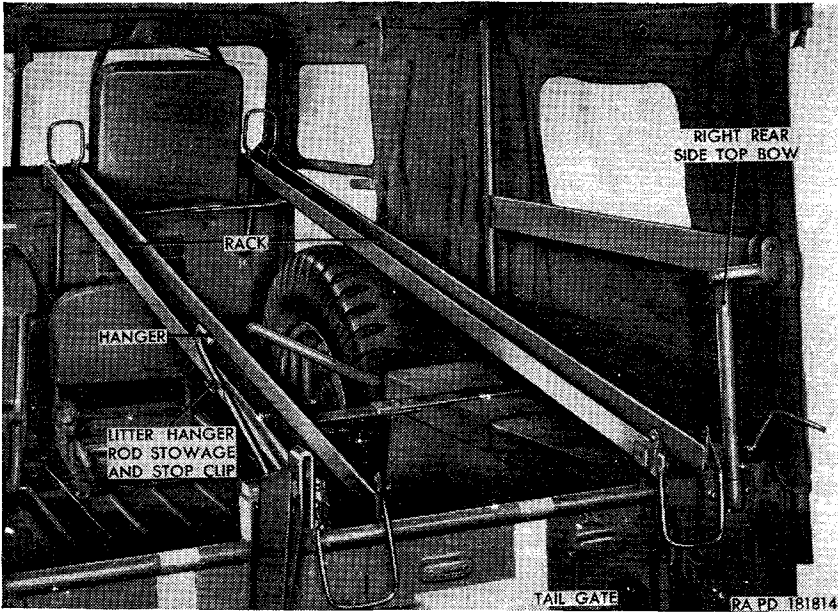

Figure 20. Upper litter rack (M170)—lowered position.

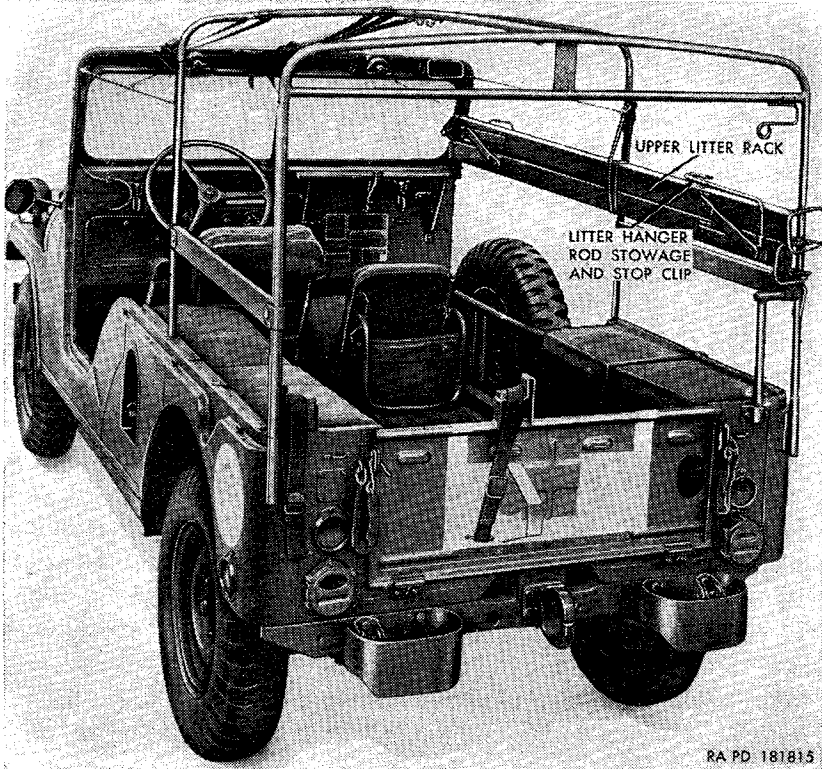

Figure 21. Upper litter rack (M170)—Stowed position.

arrangement for the protection of the patients when the lower and upper litter racks are being used.

*b. Folding Back of Driver's Seat Forward.* To fold the back of the driver's seat forward, push forward on the seat back until its front side rests on the seat cushion. To raise the seat back, lift it up to upright position.

*c. Arranging Front Passenger Seat for Passenger Use.*

*Note.* Procedures described herein are based on the assumption that the front passenger seat is arranged in crash pad position for two patients (*e* below).

- (1) Stow the upper litter rack (par. 54*d*).

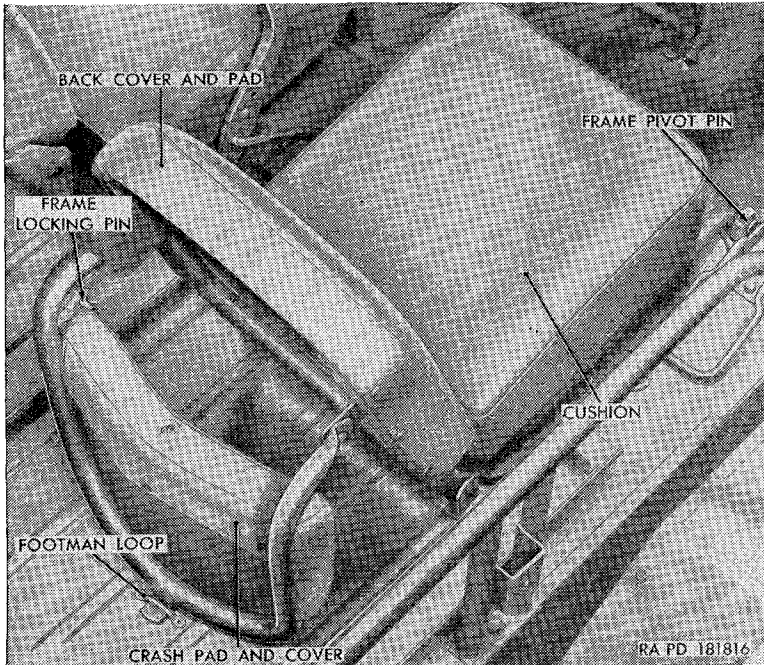

*Figure 22. Front passenger seat (M170)—passenger position.*

- (2) Withdraw the front passenger seat frame locking pin (fig. 22) from the holes in the passenger seat frame locking and retaining brackets. Tilt the front passenger crash pad and cover rearward until it rests on the floor pan. Move the portion of the crash pad, that rests on the floor pan, forward and then rearward, as necessary, until the seat frame locking bracket engages the footman loop (fig. 22) on the floor pan.
- (3) Unfasten the passenger seat stowage strap, secured to the front passenger seat cushion (fig. 18), from the upper litter front support. Unfasten the passenger seat stowage strap, secured to the footman loop on the instrument panel, from

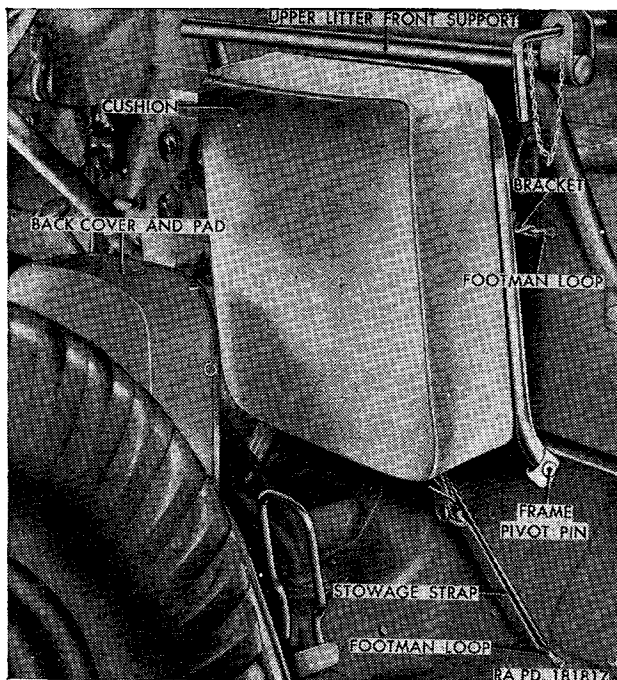

Figure 23. Front passenger seat cushion (M170)—in stowage position

the cushion (fig. 23). Lift the cushion up until the front passenger seat frame pivot pins are clear of the brackets on the windshield frame and remove cushion from windshield. Position the cushion in the driver's compartment so the frame pivot pins (fig. 22) are over the seat hinge pivots on the floor pan. Aline the flat sides of the pins with the flat faces of the pivots and insert the pins into the pivots. Tilt the seat cushion rearward until the frame rests on the floor pan.

*d. Arranging Front Passenger Seat in Stowage Position for Lower Litter Patient.*

- (1) Tilt the front passenger seat cushion (fig. 22) forward until the flat sides of the front passenger seat frame pivot pins are alined with the flat faces of the seat hinge pivots on the floor pan. Lift the cushion up until the pins are clear of the pivots and remove the cushion.
- (2) Position the front passenger seat cushion (fig. 23) against the instrument panel so the pivot pins point down, and insert the two brackets on the frame of the seat into the footman loops on the instrument panel. Fasten the passenger seat stowage strap, secured to the cushion, to the footman loop on the floor pan. Fasten the passenger seat stowage strap, secured to the footman loop on the instrument panel, to the frame of the seat cushion.

- (3) Push the rear of the front passenger crash pad and cover (fig. 22) forward until the locking bracket on the seat frame is clear of the footman loop on the floor pan. Raise and swing the crash pad and cover forward until the front passenger seat back cover and pad rests on the floor pan. Raise the crash pad and cover to upright position. Lock the crash pad in upright position by inserting the front passenger seat frame locking pin through the front passenger seat frame locking and retaining brackets.

*c. Arranging Front Passenger Seat in Crash Pad Position for Upper and Lower Litter Patients.*

- (1) Proceed as instructed in *d*(1) above.
- (2) Engage the front passenger seat frame pivot pins of the seat cushion (fig. 18) in the slots of the brackets mounted at the top of the windshield frame. Fasten the passenger seat stowage strap, secured to the seat cushion, to the upper litter front support. Secure the passenger seat stowage strap, fastened to the footman loop on instrument panel, to the frame of the seat cushion.
- (3) Proceed as instructed in *d*(3) above.

## 56. Tailgate

*a. General.* A tailgate is provided for ease of loading patients. Two holes are provided in the tailgate to permit the handles of the litter on the lower litter rack to protrude outside the vehicle when the tailgate is in raised position.

*b. Lowering.* Remove the hook of each tailgate chain, hook and cover (fig. 24) from the bracket on the body rear panel and the tail-

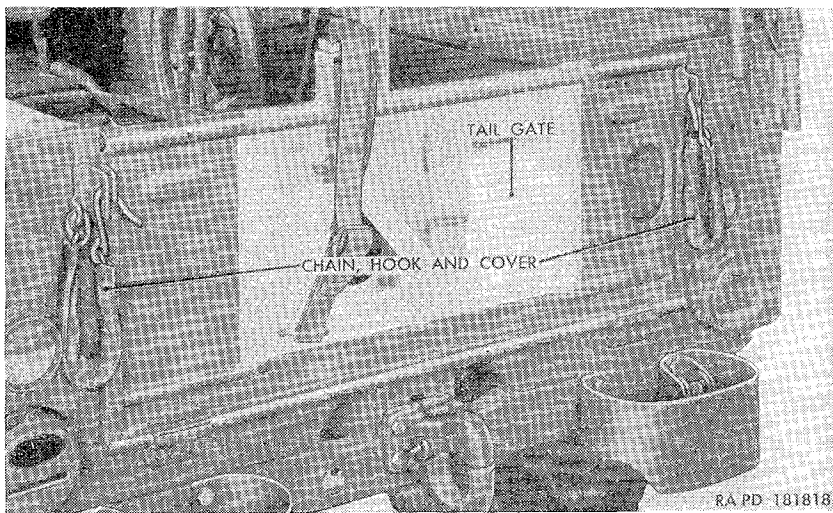

Figure 24. Tailgate (M170)—raised position.



gate lock. Lower tailgate to horizontal position and secure in lowered position by inserting the hook of each tailgate chain, hook, and cover (fig. 25) into the tailgate locks.

c. *Raising.* Remove the hook of each tailgate chain, hook, and cover (fig. 25) from the tailgate lock. Raise the tailgate to vertical position and secure in place by inserting the hook of each tailgate chain, hook, and cover (fig. 24) through the bracket on the body rear panel and the tailgate lock.

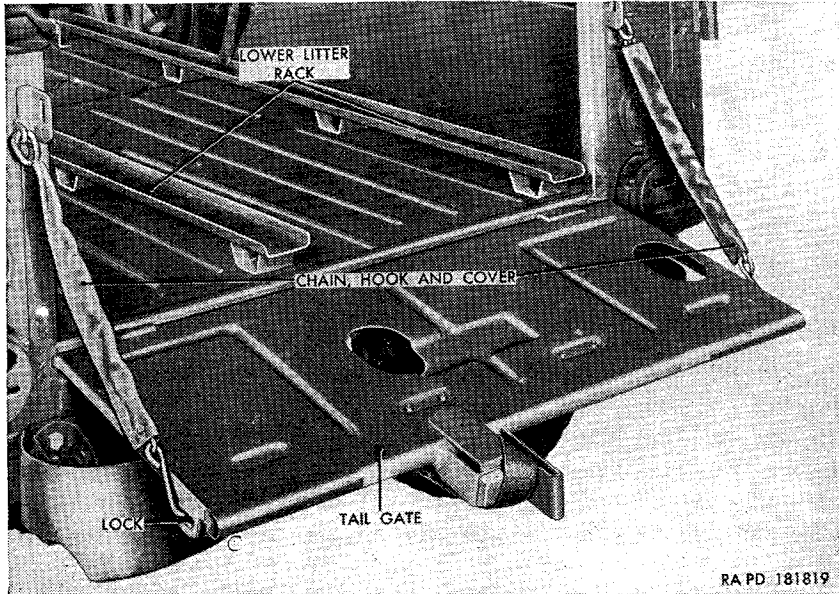

Figure 25. Tailgate (M170)—lowered position.

## 57. Medical Supplies Stowage Compartments

(fig. 26)

a. *General.* Two medical supplies stowage compartments are provided. Both compartments are located in the wheel houses; one at the rear of the right wheel house and the other at the front of the left wheel house.

b. *Opening and Closing.*

*Note.* Both medical supplies stowage compartments are opened and closed in the same manner.

To gain access to the medical supplies stowage compartment, lift the wheel house cushion that covers the compartment. To open the medical supplies stowage compartment lid, grasp the stowage compartment

lid ring and turn it 90° either clockwise or counterclockwise to unlock lid and lift lid to open position. To lock lid, lower lid until it rests on the flanges of the compartment and lock the lid in place by turning the lid ring 90° either clockwise or counterclockwise from its open position.

*Note.* Lid ring faces center of vehicle when in locked position.

After locking lid, lower the wheel house cushion until it rests on top of the wheel house.

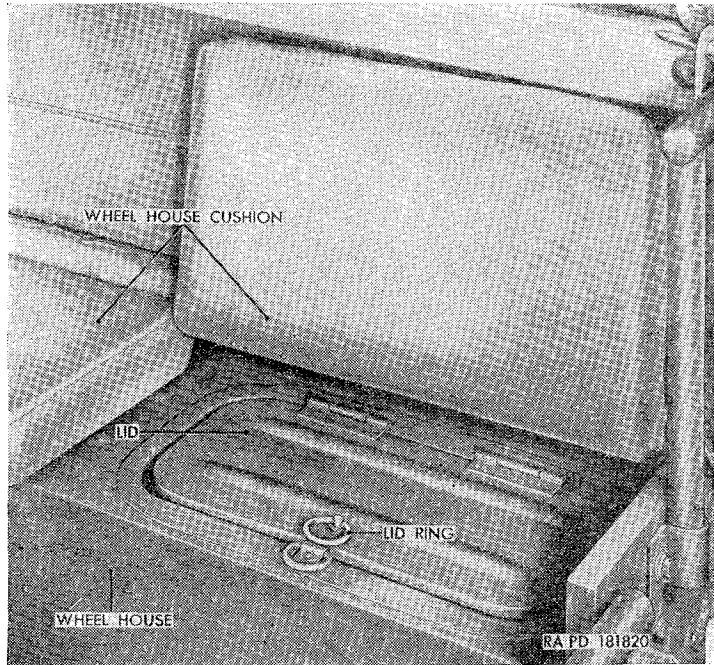

*Figure 26. Medical supplies stowage compartment in right wheel house (M170).*

## **58. Top Cover With Rear Curtain and Side Curtains** (fig. 27)

The rear curtain is equipped with three zippers. Each side of the rear curtain is secured to its respective side curtain by a zipper. The two halves of the rear curtain are also secured together by a zipper. All three zippers can be zipped or unzipped from either the outside or inside of the vehicle. Stowage straps are provided to secure the rear curtain and the side curtains in rolled-up position. Two openings are provided in the rear curtain to permit the handles of the litter on the upper litter rack to protrude outside the vehicle when the rear curtain is down.



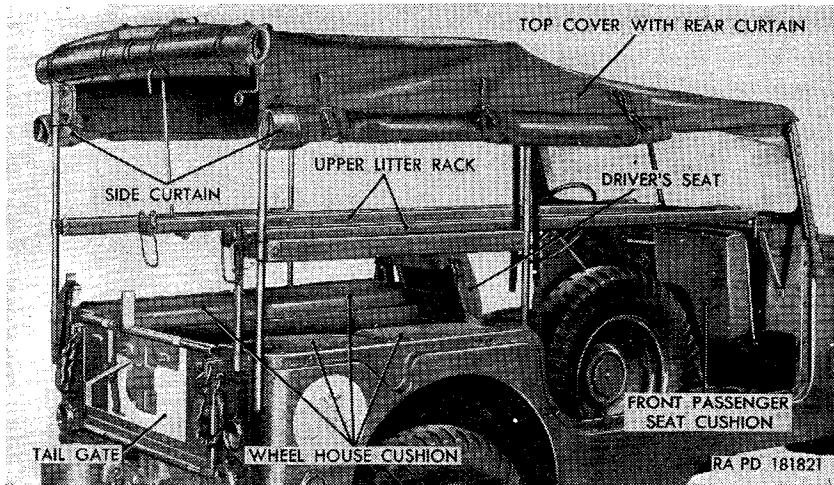

Figure 27. Rear curtain and side curtains in rolled-up position—Doors off (M170).

## Section V. OPERATION UNDER UNUSUAL CONDITIONS

### 59. General Conditions

*a.* In addition to the operating procedures described for usual conditions, special instructions of a technical nature for operating and servicing this vehicle under unusual conditions are contained or referred to herein. In addition to the normal preventive maintenance service, special care in cleaning and lubrication must be observed where extremes of temperature, humidity, and terrain conditions are present or anticipated. Proper cleaning, lubrication, and storage and handling of fuels and lubricants not only insure proper operation and functioning, but also guard against excessive wear of the working parts and deterioration of the materials.

*b.* TM 21-300 contains very important instructions on driver selection, training, and supervision; TM 21-305 prescribes special driving instructions for operating wheeled vehicles under unusual conditions.

**Caution:** It is imperative that the approved practices and precautions be followed. A detailed study of these technical manuals is essential for use of this materiel under unusual conditions.

*c.* Refer to paragraph 69 for lubrication under unusual conditions, to table II and table III for preventive maintenance checks, and to paragraphs 273 through 277 for maintenance procedures.

*d.* When chronic failure of materiel results from subjection to extreme conditions, report of the condition should be made on DA Form 468 (par. 2)

## 60. Extreme Cold Weather Conditions

### *a. General Problems.*

- (1) Extensive preparation of materiel scheduled for operation in extreme cold weather is necessary. Generally, extreme cold will cause lubricants to thicken or congeal, freeze batteries or prevent them from furnishing sufficient current for cold weather starting, crack insulation and cause electrical short circuits, prevent fuel from vaporizing and properly combining with air to form a combustible mixture for starting, and will cause the various construction materials to become hard, brittle, and easily damaged or broken.
- (2) The cooling system should be prepared and protected for temperatures below +32° F., in accordance with instructions given in TM 9-2855 on draining and cleaning the system and the selection, application, and checking of antifreeze compounds to suit the anticipated conditions.
- (3) TM 9-2855 also describes the method of correcting specific gravity readings for batteries exposed to extreme cold.
- (4) For description of operations in extreme cold, refer to TM 9-2855.

**Caution:** It is imperative that the approved practices and precautions be followed. TM 9-2855 contains information which is specifically applicable to this vehicle as well as to all other vehicles. It must be considered an essential part of this manual, not merely an explanatory supplement to it.

*b. Winterization Equipment.* Special equipment is provided for the vehicle when protection against extreme cold weather (0° to -65° F.) is required. This equipment is issued as specific kits. Each kit contains a technical bulletin which provides information on description, installation instructions, and methods of use. TM 9-2855 contains general information on winterization equipment and processing.

*c. Fuels, Lubricants, and Antifreeze Compound (Storage, Handling, and Use).*

- (1) The operation of equipment at arctic temperatures will depend to a great extent upon the condition of the fuels, lubricants, and antifreeze compounds used in the equipment. Immediate effects of careless storage and handling or improper use of these materials are not always apparent, but any deviation from proper procedures may cause trouble at the least expected time.
- (2) In arctic operations, contamination with moisture is a source of many difficulties. Moisture can be the result of snow getting into the product, condensation due to "breathing" of a partially filled container, or moisture condensed

from warm air in a partially filled container when a product is brought outdoors from room temperature. Other impurities will also contaminate fuels and lubricants so their usefulness is impaired.

- (3) Refer to TM 9-2855 for detailed instruction on storage, handling, and use.

## 61. Extreme Cold Weather Operation

### a. General.

- (1) The drive must always be on the alert for indications of the effect of cold weather on the vehicle.
- (2) The driver must be very cautious when placing the vehicle in motion after a shutdown. Congealed lubricants may cause failure of parts. Tires frozen to the ground or frozen to the shape of the flat spot while underinflated must be considered. One or more brake shoes may be frozen fast and require preheating to avoid damage to the clutch surfaces. After warming up the engine thoroughly, place transmission in first gear, transfer in low range, and engage front driving axle (par. 43) and drive vehicle slowly approximately 100 yards, being careful not to stall the engine. This should heat gears and tires to a point where normal operation can be expected.
- (3) Constantly note instrument readings. If instrument reading consistently deviates from normal, stop the vehicle and investigate cause. A special engine thermostat provided in the arctic winterization kit opens at 180° F., and at this temperature the engine will give best results. If engine temperature gage reading consistently exceeds 200° F., adjust flap on radiator winterfront cover to admit more air.

### b. At *Halt or Parking*.

- (1) When halted for short shutdown periods, the vehicle should be parked in a sheltered spot out of the wind. If no shelter is available, park so that the vehicle does not face into the wind. For long shutdown periods, if high ground is not available, prepare a footing of planks or brush. Chock in place if necessary.
- (2) When preparing a vehicle for shutdown periods, place all control levers in neutral position to prevent possible freezing in an engaged position. Freezing may occur when water is present due to condensation.
- (3) Clean all parts of the vehicle of snow, ice, and mud as soon as possible after operation. Refer to table II for detailed after-operation procedures. If the winter front cover is not installed, be sure to protect all parts of the engine and engine accessories against entrance of loose, drifting snow during the

halt. Snow flurries penetrating the engine compartment may enter the crankcase filler vent, etc. Cover and shield the vehicle but keep the ends of the canvas paulins off the ground to prevent them from freezing to the ground.

- (4) If no power plant heater is present, the battery should be removed and stored in a warm place.
- (5) Refuel immediately in order to reduce condensation in the fuel tank. Prior to refueling, open fuel tank drain and drain off accumulated water.
- (6) When the vehicle is equipped with a power plant heater as provided by the arctic winterization kit, immediately after engine "shutdown," start the power plant heater and check to be sure it operates effectively. The heater should avoid the necessity of removing the battery to warm storage, and is designed to operate unattended during overnight stops. Instructions for operation of winterization equipment is contained in pamphlet packed with the kit.
- (7) Correct tire inflation pressure is prescribed in paragraph 248*b*.
- (8) When drain plugs have been removed or drain cocks opened to remove liquid from the cooling system of any equipment, the drains will be inspected to be sure none are obstructed. If the drain hole has become obstructed by foreign material, a soft wire should be used to clear the hole of the obstruction. This is particularly important before leaving a vehicle that has had the engine drained to protect the block from freezing. The draining of an engine cooling system to prevent freezing will be done only when no approved antifreeze is available.

## **62. Operation in Extreme Hot Weather Conditions**

*a. General.* Continuous operation of the vehicle at high speeds or long hard pulls in low gear positions on steep grades or in soft terrain may cause the vehicle to register overheating. Avoid the continuous use of low gear ratios whenever possible. Continuously watch the temperature and halt the vehicle for a cooling-off period whenever necessary and the tactical situation permits. Frequently inspect and service cooling system (par. 127), oil filter (par. 114), and air cleaner (par. 136). If the engine temperature consistently rises above 200° F., look for dust, sand, or insects in radiator fins and blow out any accumulation with compressed air or water under pressure. Flush cooling system if necessary (TM 9-2858).

*b. At Halt or Parking.*

- (1) Do not park the vehicle in the sun for long periods, as the heat and sunlight will shorten the life of the tires. If possible, park vehicle under cover to protect it from sun, sand, and dust.

- (2) Cover inactive vehicles with paulins if no other suitable shelter is available. Where entire vehicle cannot be covered, protect window glass against sand etching, and protect engine compartment against entry of sand.
- (3) Correct tire inflation pressure is prescribed in paragraph 248b.
- (4) Vehicles inactive for long periods in hot humid weather are subject to rapid rusting and accumulation of fungi growth. Make frequent inspections and clean and lubricate to prevent excessive deterioration.
- (5) Exterior surfaces which are not painted should be coated with a light film of engine lubricating oil.

### **63. Operation on Unusual Terrain**

#### *a. General.*

- (1) Vehicle operation on snow or ice and in deep mud requires the use of tire chains. Tire chains must be installed in pairs (front and rear) to prevent power train damage and wear. Select a gear ratio low enough to move vehicle steadily and without imposing undue driving strain on engine and power train. However, racing of the engine for extended periods must be avoided.

*Note.* Avoid excessive clutch slippage.

- (2) Operators must at all times know the position in which the front wheels are steering, as the vehicle may travel straight-ahead even though the wheels are cramped right or left. A piece of string tied to the front portion of the steering wheel rim in "straightahead" position will indicate to the driver whether the front wheels are "ploughing." This ploughing action may cause the vehicle to stall or suddenly veer to right or left.
- (3) If one or more wheels become mired and others spin, it may be necessary for the vehicle to be winched or towed by a companion vehicle or to jack up the wheel which is mired and insert planking or matting beneath it. Do not jam sticks or stones under a spinning wheel, as this only forms an effective block and will wear the tire tread unnecessarily.
- (4) Operation in sand requires daily cleaning of air cleaner, (par. 136), fuel filter (par. 139), and oil filters (par. 114). Engine vents and other exposed vents should be covered with cloth.
- (5) At high altitudes, coolant in vehicles boils at proportionately lower points than 212° F., thus, it will be necessary to keep a close watch on the engine temperature during the summer months.

*b. Recommended Tire Pressures.* Lowering of tire pressure in cases of sand, ice, mud, and snow will help to increase traction if tire chains are not available.

*Note.* Do not lower tire pressure to the extent that damage will result to tires. Tire pressures are tabulated in paragraph 248*b*. When negotiating hard baked sand, avoid breaking through the crust. A road bed of canvas or planking is suitable on short stretches to insure against this possibility.

*c. After-Operation Procedures.* Remove accumulations of ice, snow, and mud from under the fenders and from the wheels, radiator core, engine compartment, steering knuckles, flanges and arms, brake cylinder boot and hoses, crankcase breather, air cleaner, and all control and electrical connections.

**Caution:** Exercise care when removing such accumulations in order to prevent damage to the affected parts.

## 64. Fording Operations

*a. General.* In fording, vehicles may be subjected to water varying in depth from only a few inches to a depth sufficient to completely submerge the vehicle. Factors to be considered are spray-splashing precautions, normal fording capabilities, deep-water fording using fording kits, and accidental complete submersion.

*b. Normal Fording.* Fording of bodies of water up to maximum vehicle fording depth of 37½ inches is based on the standard vehicle with water proofing protection provided for critical units when manufactured, but without deep water fording kit. Observe the precautions listed below:

- (1) Engine must be operating at maximum efficiency.
- (2) Master cylinder must be filled to reduce the entrance of water.
- (3) Make sure that battery cell vent caps are snug and that the bell housing plug is installed.
- (4) Engage front axle drives. Shift transmission to lowest speed positions. Speed up engine to overcome the possibility of a "stall" when the cold water chills the engine. Enter the water slowly. Should the engine stall while submerged, it may be started in the usual manner (par. 42).
- (5) All normal fording should be at speeds of from 3 to 4 mph to avoid forming a "bow wave." Avoid using the clutch if possible because frequent use while submerged may cause the clutch to slip. If the ford is deep enough for the spinning fan blades to catch water, loosen the fan belts before crossing (par. 130a) otherwise, they may throw water over the electrical units. The brakes will usually be "lost," but in some cases may "grab" after emergence. Applying the brakes a few times after dry land has been reached will help dry out the brake linings.

(6) If accidental complete submersion occurs, the vehicle will be salvaged, temporary preservation applied as outlined in paragraph 276 and then sent to the ordnance maintenance unit as soon as possible for necessary permanent maintenance.

*c. Deep-Water Fording.* Refer to TM 9-2853 for general information, descriptions, and methods of use of deep-water fording kits, and for general procedures for the operation of vehicles so equipped.

*d. After-Fording Operations.* Immediately after vehicle emerges from the water, remove the bell housing plug and open all drain holes in body. Also, at the earliest opportunity, check the engine oil level and check for presence of water in the crankcase. Heat generated by driving will evaporate or force out most water which has entered at various points. Also, any *small* amount of water which has entered the crankcase either through leakage or due to condensation will usually be dissipated by the ventilating system. Refer to paragraph 276 for maintenance operations after fording.

## CHAPTER 3

### ORGANIZATIONAL MAINTENANCE INSTRUCTIONS

---

#### Section I. PARTS, SPECIAL TOOLS, AND EQUIPMENT FOR OPERATION AND ORGANIZATIONAL MAINTENANCE

##### 65. General

Tools, equipment, and spare parts are issued to the using organization for maintaining the materiel. Tools and equipment should not be used for purposes other than prescribed and, when not in use, should be properly stored in the chest and/or roll provided for them.

##### 66. Parts

Spare parts are supplied to the using organization for replacement of those parts most likely to become worn, broken, or otherwise un-serviceable, providing replacement of these parts within the scope of organizational maintenance functions. Spare parts, tools, and equipment supplied for the ¼-ton 4 x 4 utility truck M38A1 and ¼-ton 4 x 4 front line ambulance M170 are listed in Department of the Army Supply Manual ORD 7 SNL G-758, which is the authority for requisitioning replacements.

##### 67. Common Tools and Equipment

Standard and commonly used tools and equipment having general application to this materiel are authorized for issue to 1st echelon by ORD 7 SNL G-758. Common tools and equipment for 2d echelon are listed in ORD 6 SNL J-7, Sections 1, 2 and 3 and ORD 6 SNL J-10, Section 4, and are authorized for issue by TA and TOE.

##### 68. Special Tools and Equipment

Certain tools and equipment specially designed for operation and organizational maintenance, repair, and general use with the materiel are listed in table I for information only. This list will not be used for requisitioning replacements.



*Table I. Special Tools and Equipment for Operation and Organizational Maintenance*

Item	Identifying No.	References		Use
		Figure	Par.	
ADAPTER, puller steering wheel.	(41-A-18-251)	28, 154	229	Removing steering wheel.
PULLER, water pump pulley.	B7950710 (41-P-2908-240)	28, 63	131	Removing fan and water pump pulley.
REMOVER and REPLACER, bearing cup (spindle pin), thd $\frac{3}{4}$ -16NF-2, female, (used w/SCREW 41-S-1047-300).	(41-R-2374-750)	28, 142	213	Removing steering knuckle flange bearing cups.
REMOVER and REPLACER, bearing cup (wheel) (used w/SCREW 41-S-1047-330).	(41-R-2374-845)	28, 138	208	Removing and installing front hub bearing cup.
SCREW, remover and replacer (bearing cup) thd $\frac{3}{4}$ -16NF-2, lgh 6 in.	(41-S-1047-300)	28, 142	213	Used w/RE-MOVER and REPLACER 41-R-2374-750.
SCREW, remover and replacer (bearing cup) thd $1\frac{1}{4}$ -12NF-2.	(41-S-1047-330)	28, 138	208	Used w/RE-MOVER and REPLACER 41-R-2374-845.
WRENCH, wheel hub nut, $2\frac{1}{8}$ -in. hex.	(41-W-3825-200)	28, 135	207	Removing and installing front hub bearing jam and adjusting nuts.

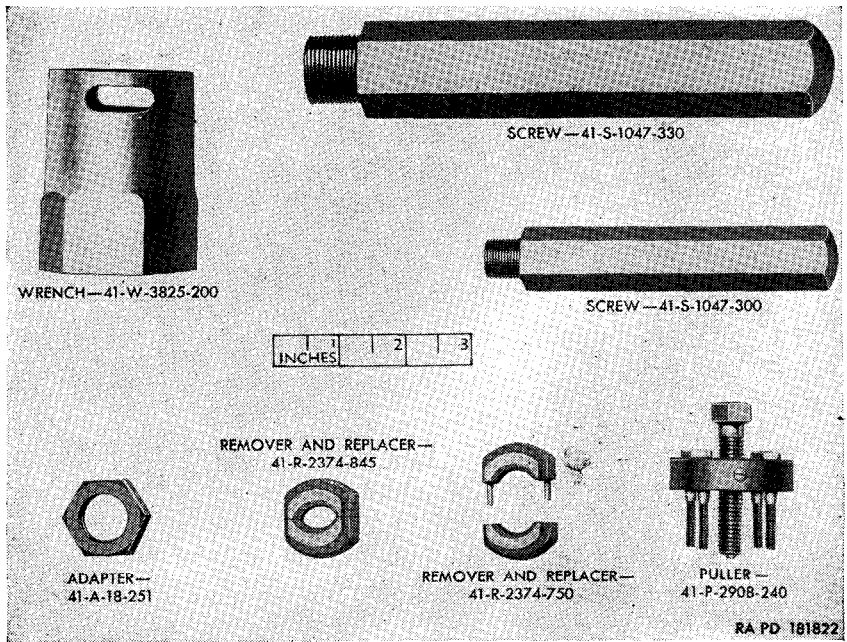

Figure 28. Special tools and equipment for operation and organizational maintenance.

## Section II. LUBRICATION AND PAINTING

### 69. Lubrication Chart

The lubrication chart (figs. 29 and 30) prescribes cleaning and lubricating procedures as to locations, intervals, and proper materials for these vehicles. When the revised official lubrication order is available, it will be issued with each vehicle and is to be carried with it at all times. In the event the vehicle is received without a copy, the using organization will immediately requisition one. See DA Pamphlet 310-4 for lubrication order of current date. Lubrication which is to be performed by ordnance maintenance personnel is listed on the lubrication chart in the NOTES.

### 70. General Lubrication Instructions

*a. General.* Special lubricating instructions required for specific mechanism or parts are covered in the pertinent section.

*b. Usual Conditions.* Service intervals specified on the lubrication chart are for normal operation and where moderate temperature, humidity, and atmospheric conditions prevail.

*c. Lubrication Equipment.* Each vehicle is supplied with lubrication equipment adequate for its maintenance. Operate the lubricating

# LUBRICATION CHART

## TRUCK, 1/4-TON 4x4, M38A1, M170

References TM 9-8014, ORD 9 SNL G-758

Intervals are based on normal operation. Reduce to compensate for abnormal operation, severe conditions or contaminated lubricants. During inactive periods, intervals may be extended commensurate with adequate preservation. Relubricate after washing or fording.

Clean fittings before lubricating. Clean parts with THINNER, paint, volatile mineral spirits (TPM) or SOLVENT, dry cleaning (SD). Dry before lubricating. Lubricate dotted arrow points on both sides of the equipment.

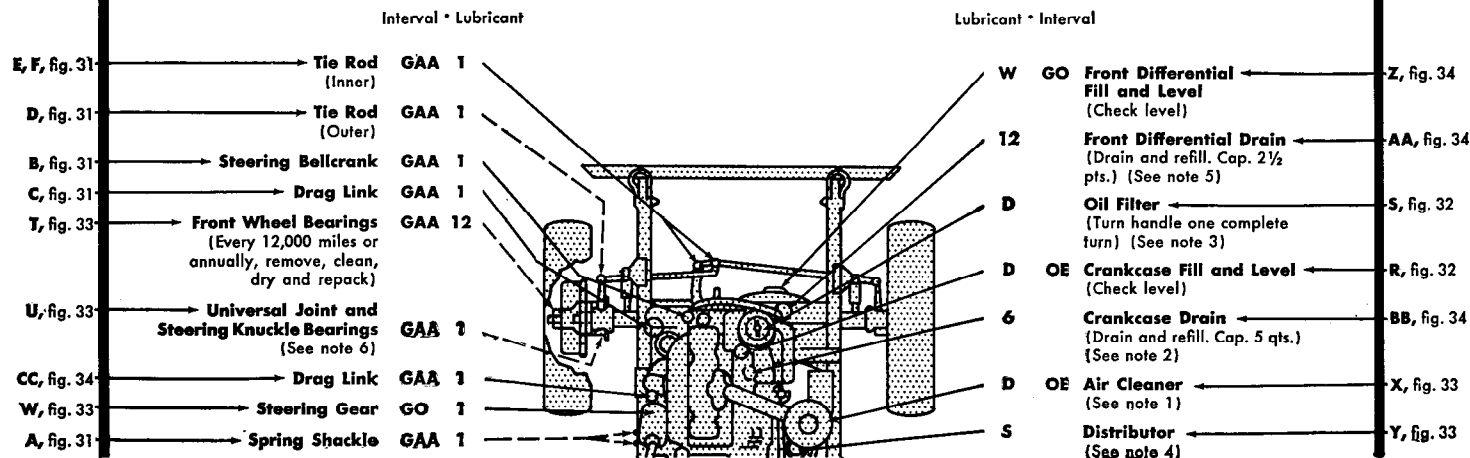

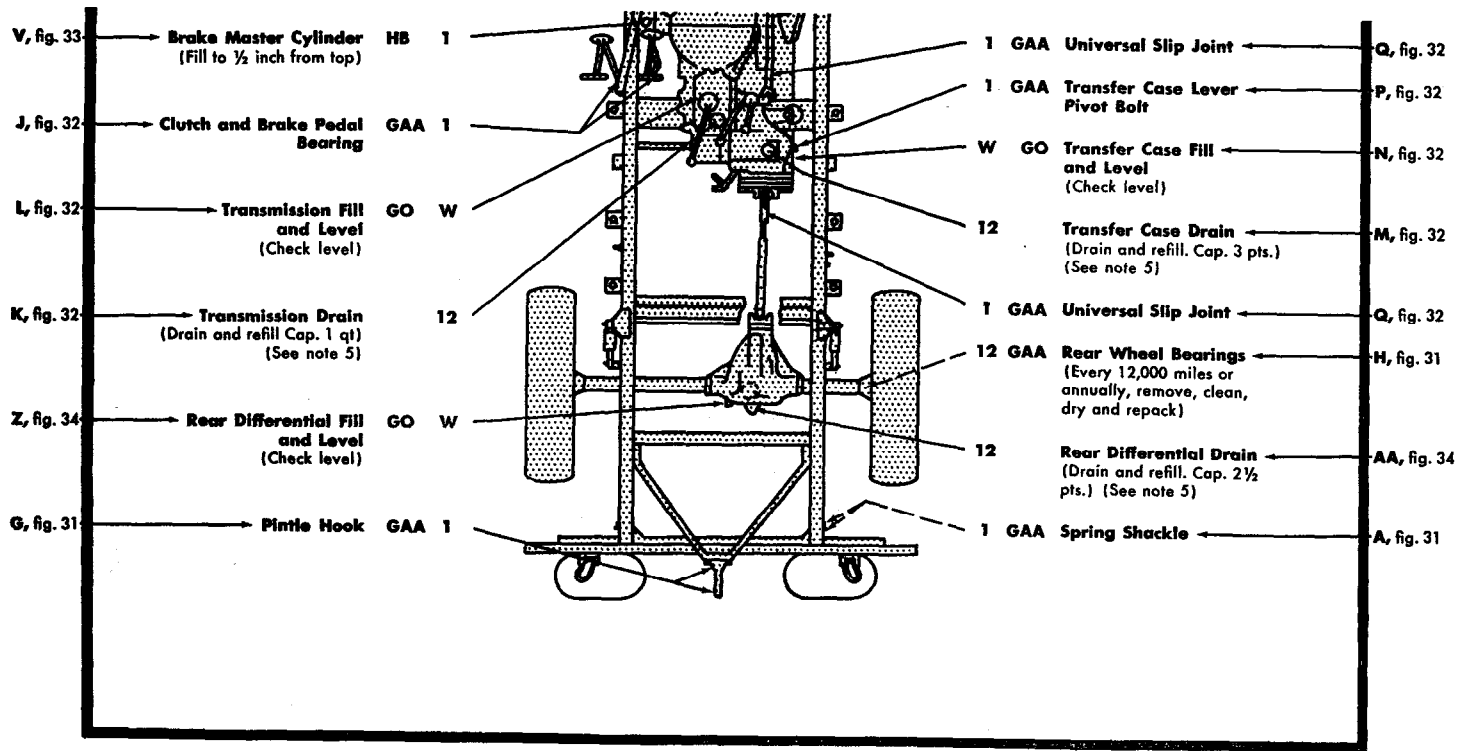

RA PD 181823

Figure 29. ¼-ton 4 x 4 utility truck M38A1 and ¼-ton 4 x 4 front line ambulance M170 lubrication chart.

— KEY —

LUBRICANTS	EXPECTED TEMPERATURES			FOR ARCTIC OPERATION refer to TAMP-2855	LUBRICANTS	INTERVALS			
	above +32° F	+40°F to -10°F	0°F to -65°F						
OE—OIL, lubr, engine	OE 30	OE 10	OES		OES—OIL, lubr, engine, sub-zero	D—Daily			
GO—LUBRICANT, gear, universal	GO 90	GO 75	GOS			GOS—LUBRICANT, gear, universal, sub-zero	W—Weekly		
GAA—GREASE, lubr, automotive and artillery	GAA	GAA	GAA					HBA—FLUID, hydraulic brake, arctic	S—Semiannually
HB—FLUID, hydraulic brake	HB	HB	HBA						
PL—OIL, lubr, preservative	PL (Med)	PL (Special)	PL (Special)						
						12—12,000 Miles			

— NOTES —

- AIR CLEANER and Breather**—[Oil Bath Type] Daily, replenish to bead level with OE, crankcase grade. Every 1,000 miles, clean oil reservoir and refill with OE as above. Disassemble, clean all parts, refill with OE as above whenever crankcase oil is changed. For desert or extremely dusty operation, disassemble, clean all parts and refill with OE once every operating day or more frequently if required.
- CRANKCASE**—Drain every 6,000 miles or semiannually. Drain only when engine is hot. Refill to FULL mark. Run engine a few minutes, recheck level. For satisfactory operation on heavy duty engine oil, engine thermostat must be operating properly to maintain engine coolant temperature at +140° F minimum. CAUTION: Be sure pressure gauge indicates oil is circulating.
- OIL FILTER**—Every 1,000 miles, remove plug in

bottom of case and drain sediment. Every 6,000 miles or semiannually, while crankcase is being drained, remove, clean and inspect element, clean inside of case, install element.

- DISTRIBUTOR**—Semiannually, wipe breaker cam lightly with GAA and lubricate breaker arm pivot and wick under rotor with 1 to 2 drops of PL. Remove distributor, remove plug and wick under name plate, soak felt wick in preservative oil. Fill cavity with GAA. Insert wick, remove excess grease and install plug.
- GEAR CASES**—Drain every 12,000 miles or annually. Drain only when hot after operation. Fill to plug levels before operation and after draining. Clean vents weekly and after operation in water or mud.
- UNIVERSAL JOINT AND STEERING KNUCKLE BEARINGS**—Every 1,000 miles, re-

move plug and fill to level. When wheels are removed for packing, remove steering knuckles, clean and repack universal joint housing. Do not disassemble constant velocity universal joint.

- OIL CAN POINTS**—Every 1,000 miles, lubricate hand brake linkage, clutch and brake pedal linkage, pintle hook if not equipped with fittings, with PL.
- DO NOT LUBRICATE**—Shock absorbers, springs, clutch release bearing, water pump.
- LUBRICATED AT TIME OF DISASSEMBLY BY ORDNANCE PERSONNEL**—Ventilator dual valve control, throttle control, choke control, steering column bearing (upper), generator, starter, clutch fulcrum ball, clutch release bearing carrier, clutch pilot bearing, hand brake cable, speedometer flexible shaft.

RA PD 181824

Figure 30.  $\frac{1}{4}$ -ton  $\frac{1}{4}$  x  $\frac{1}{4}$  utility truck M38A1 and  $\frac{1}{4}$ -ton  $\frac{1}{4}$  x  $\frac{1}{4}$  front line ambulance M170 lubrication chart.

guns carefully and in such a manner as to insure a proper distribution of the lubricant.

*d. Points of Application.*

- (1) Lubrication fittings, grease cups, oilers and oilholes are shown in figures 31 through 34 and are referenced to the lubrication chart. Wipe these devices and the surrounding surfaces clean before and after lubricant is applied.
- (2) A  $\frac{3}{4}$ -inch red circle should be painted around all lubricating fittings and oilholes.
- (3) Clean and lubricate unsealed bearings as shown below.
  - (a) Wash all the old lubricant out of the bearings and from the inside of the hubs with volatile mineral spirits or dry-cleaning solvent and dry the parts thoroughly.

**Caution:** Bearings must not be dried or spun with compressed air. See TM 37-265 for care and maintenance of bearings.

- (b) Pack the bearings by hand or with a mechanical packer, introducing the lubricant carefully between the rollers. Do not smear grease only on the outside of the bearings and expect it to work in. Great care must be exercised to insure that dirt, grit, lint, or other contaminants are not introduced into the bearings. If the bearings are not to be installed immediately after repacking, they should be wrapped in clean oilproof paper to protect from contaminants.
  - (c) After the bearings are properly lubricated, pack the hub with a sufficient amount of lubricant to uniformly fill it to the inside diameters of the inner and outer bearing races. Coat the spindles and hub caps with a thin layer of lubricant (not over one-sixteenth of an inch) to prevent rusting. Do not fill the hub caps to serve as grease cups under any circumstances. They should be lightly coated, however, to prevent rusting.

*Note.* For normal operation, lubricate wheel bearings at 12,000 miles or at annual intervals, whichever comes first.

*e. Reports and Records.*

- (1) Report unsatisfactory performance of prescribed petroleum fuels, lubricants, or preserving materials, using DA Form 468.
- (2) Maintain a record of lubrication of the vehicle on DA Form 461, Preventive Maintenance Service and Inspection for Wheeled and Half-Track Vehicles.

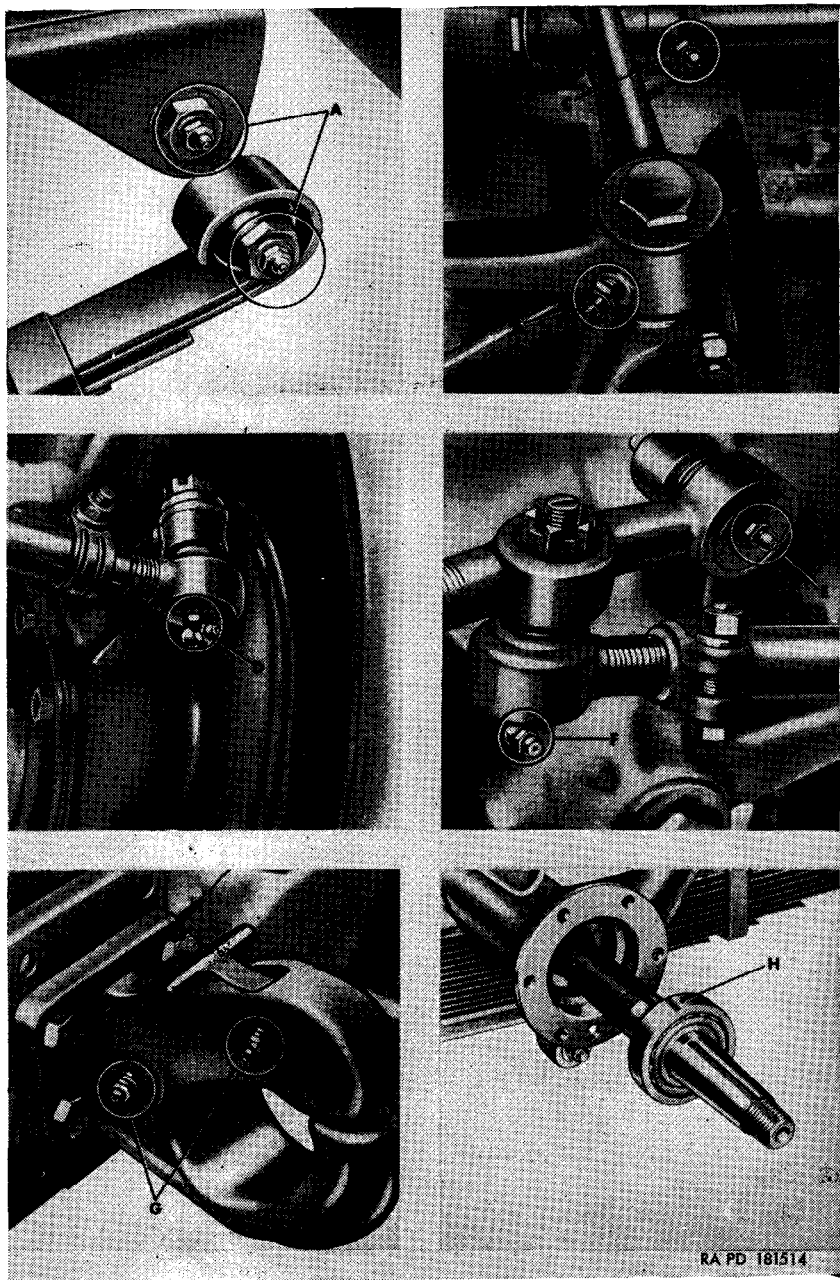

Figure 31. Localized lubrication points A through H.

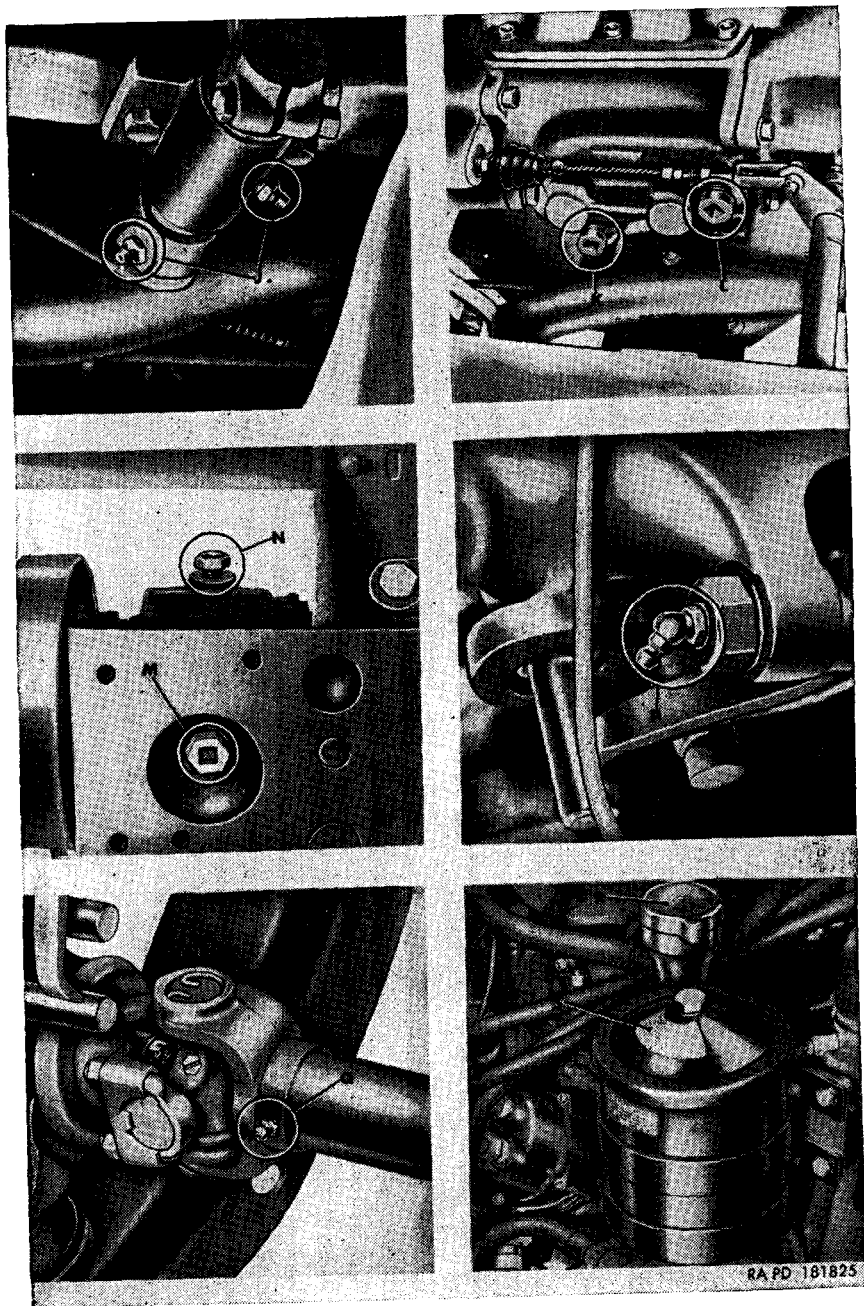

Figure 32. Localized lubrication points J through S.



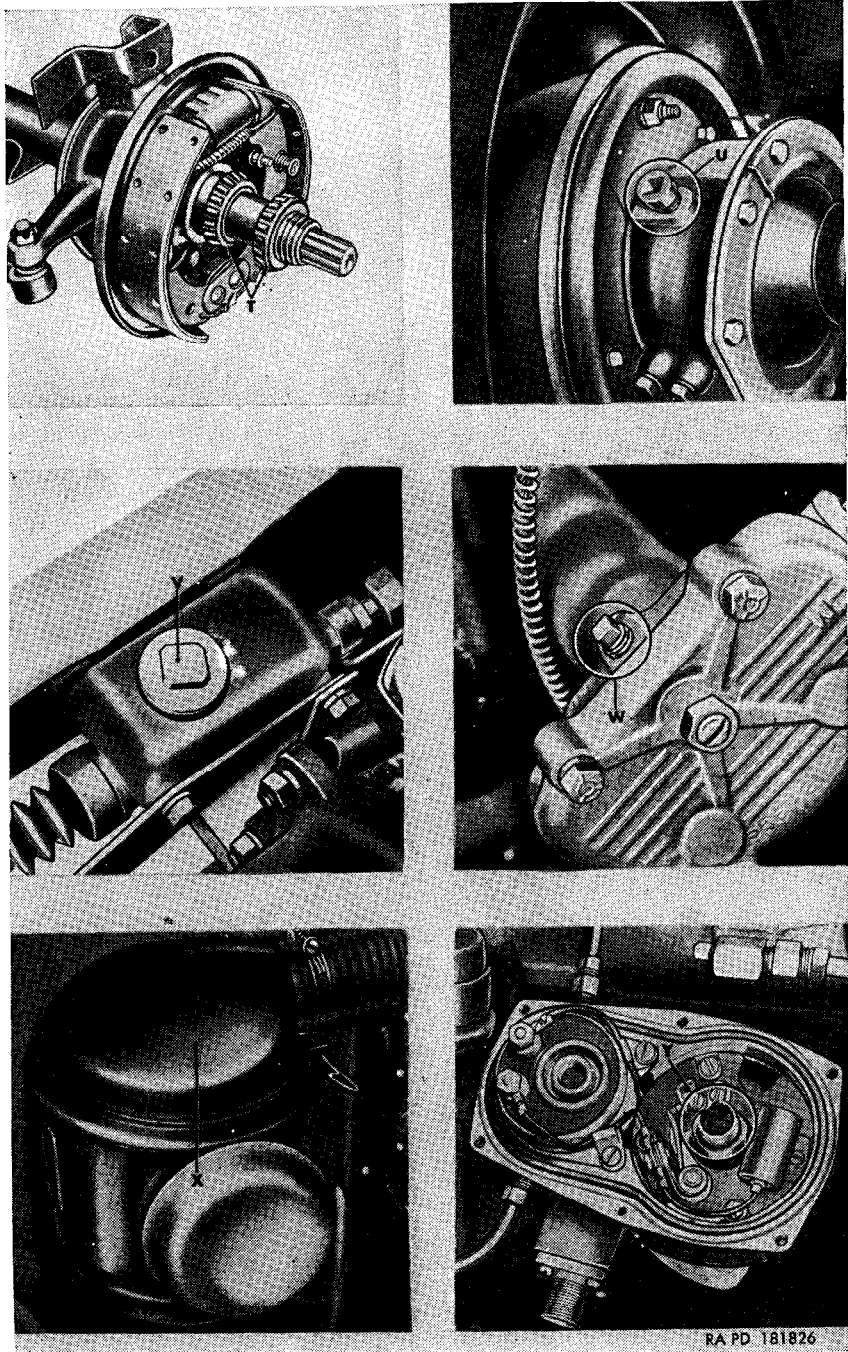

Figure 33. Localized lubrication points T through Y.

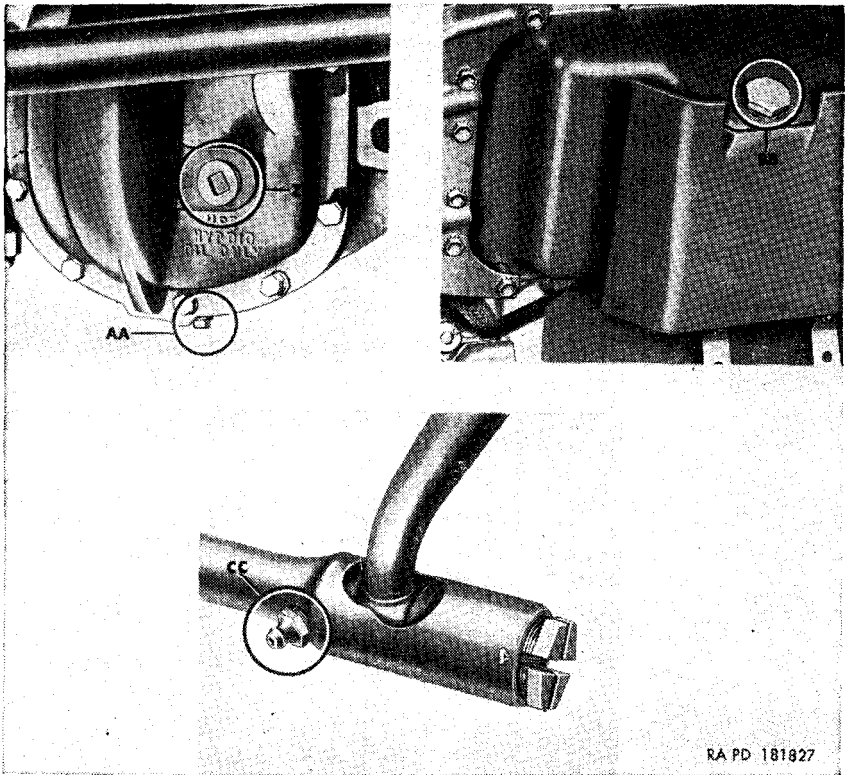

Figure 34. Localized lubrication points Z through CC.

## 71. Lubrication Under Unusual Conditions

*a. Unusual Conditions.* Reduce service intervals specified on the lubrication chart, i. e., lubricate more frequently, to compensate for abnormal or extreme conditions, such as high or low temperatures, prolonged periods of high speed operations, continued operation in sand or dust, immersion in water, or exposure to moisture. Any of these operations or conditions may cause contamination and quickly destroy the protective qualities of the lubricants. Intervals may be extended during inactive periods, commensurate with adequate preservation.

*b. Changing Grade of Lubricants.* Lubricants are prescribed in the "Key" (fig. 30) in accordance with three temperature ranges: above  $+32^{\circ}$  F.,  $+40^{\circ}$  to  $-10^{\circ}$  F., and from  $0^{\circ}$  to  $-65^{\circ}$  F. Change the grade of lubricants whenever weather forecast data indicates air temperatures will be consistently in the next higher or lower temperature range or when sluggish starting caused by lubricant thickening occurs. No change in grade will be made when a temporary rise in temperature is encountered.

*c. Maintaining Proper Lubricant Levels.* Lubricant levels must be observed closely and necessary steps taken to replenish in order to maintain proper levels at all times.

## **72. Lubrication for Continued Operation Below 0° F.**

Refer to TM-2855 for instructions on necessary special preliminary lubrication of the vehicle, and to TB 9-2855-3 for instructions on installation of the winterization kit.

## **73. Lubrication After Fording Operations**

*a.* After any fording operation in water 12 inches or over, lubricate all chassis points to cleanse bearings of water or grit as well as any other points required in accordance with paragraph 276, for maintenance operations after fording.

*b.* If the vehicle has been in deep water for a considerable length of time or was submerged beyond its fording capabilities, precautions must be taken as soon as practicable to avoid damage to the engine and other vehicle components as shown below.

- (1) Perform a complete lubrication service (par. 69).
- (2) Inspect engine crankcase oil. If water or sludge is found, drain the oil and flush the engine with preservative engine oil PE-30. Before putting in new oil, drain the oil filter and install a new filter element (par. 114).

*Note.* If preservative engine oil is not available, engine lubricating oil OE-30 may be used.

- (3) Operation in bodies of salt water enhances the rapid growth of rust and corrosion, especially on unpainted surfaces. It is most important to remove all traces of salt water and salt deposits from every part of the vehicle. For assemblies which have to be disassembled, dried, and relubricated, perform these operations as soon as the situation permits. Wheel bearings must be disassembled and repacked after each submersion. Regardless of the temporary measures taken, the vehicle must be delivered as soon as practicable to the ordnance maintenance unit.

## **74. Lubrication After Operation Under Dusty or Sandy Conditions**

After operation under dusty or sandy conditions, clean and inspect all points of lubrication for fouled lubricants and relubricate as necessary.

*Note.* A lubricant which is fouled by dust and sand makes an abrasive mixture that causes rapid wear of parts.

## 75. Painting

Instructions for the preparation of the materiel for painting, methods of painting, and materials to be used are contained in TM 9-2851. Instructions for camouflage painting are contained in FM 5-20B. Materials for painting are listed in ORD 7 SNL-758.

### Section III. PREVENTIVE MAINTENANCE SERVICES

## 76. General

*a. Responsibilities and Intervals.* Preventive maintenance services are the responsibility of the using organization. These services consist generally of daily operator's services (daily A services) performed by the operator or crew; biweekly services (biweekly B services) performed by the crew (under supervision of the squad, section, and platoon leaders); and scheduled services to be performed by organizational maintenance personnel. (C and D services.) Intervals are based on normal operations. Reduce intervals for abnormal operations or severe conditions. Intervals during inactive periods may be extended accordingly.

*b. Definitions of Terms.* Inspections to see if items are in good condition, correctly assembled or stowed, secure, not excessively worn, not leaking, and adequately lubricated apply to most items in the preventive maintenance and inspection procedures. Any or all of these checks that are pertinent to any item (including supporting, attaching, or connecting members) will be performed automatically, as general procedures, in addition to any specific procedures given.

- (1) Inspection for "good condition" is usually a visual inspection to determine if the unit is safe or serviceable. "Good condition" is explained further as meaning: not bent or twisted, not chafed or burned, not broken or cracked, not bare or frayed, not dented or collapsed, not torn or cut, not deteriorated.
- (2) Inspection of a unit to see if it is "correctly assembled or stowed" is usually a visual inspection to see if the unit is in its normal position in the vehicle and if all its parts are present and in the correct relative positions.
- (3) Inspection of a unit to see if it is "secure" is usually a visual, hand-feel, pry-bar, wrench, or screwdriver inspection for looseness in the unit. This inspection will include any brackets, lockwashers, locknuts, locking wires, and cotter pins as well as any connecting tubes, hoses, or wires.
- (4) "Excessively worn" is understood to mean worn beyond serviceable limits, or likely to fail if not replaced before the next scheduled inspection. Excessive wear of mating parts or linkage connections is usually evidenced by too much play

(lash or lost motion). It includes illegibility as applied to markings, data and caution plates, and printed matter.

- (5) Where the instruction "tighten" appears in the procedures, it means tighten with a wrench, even if the item appears to be secure.
- (6) Such expressions as "adjust if necessary" or "replace if necessary" are not used in the specific procedures. It is understood that whenever inspection reveals the need of adjustments, repairs, or replacements, the necessary action will be taken.

## 77. Cleaning

*a. General.* Special cleaning instructions required for specific mechanisms or parts are contained in the pertinent section. General cleaning instructions are as shown below.

- (1) Name plates, caution plates, and instructions plates made of steel rust very rapidly. When found to be in a rusty condition, they should be thoroughly cleaned and heavily coated with an application of lacquer.
- (2) Use dry-cleaning solvent or volatile mineral spirits to clean or wash grease or oil from all parts of the vehicle.
- (3) A solution of one part grease-cleaning compound to four parts dry-cleaning solvent or volatile mineral spirits may be used for dissolving grease and oil from engine blocks, chassis, and other parts. Use cold water to rinse off any solution which remains after cleaning.
- (4) After the parts are cleaned, rinse and dry them thoroughly. Apply a light grade of oil to all polished metal surfaces to prevent rusting.
- (5) Before installing new parts, remove any preservative materials, such as rust-preventive compound, protective grease, etc.; prepare parts as required (oil seals, etc.); and for those parts requiring lubrication, apply the lubricant prescribed in the lubrication chart (par. 69).

### *b. General Precautions in Cleaning.*

- (1) Dry-cleaning solvent and volatile mineral spirits are inflammable and should not be used near an open flame. Fire extinguishers should be provided when these materials are used. Use only in well ventilated places.
- (2) These cleaners evaporate quickly and have a drying effect on the skin. If used without gloves, they may cause cracks in the skin and, in the case of some individuals, a mild irritation or inflammation.
- (3) Avoid getting petroleum products, such as dry-cleaning solvent, volatile mineral spirits, engine fuels, or lubricants on rubber parts as they will deteriorate the rubber.

- (4) The use of diesel fuel oil, gasoline, or benzene (benzol) for cleaning is prohibited.

## 78. Preventive Maintenance by Driver or Operator

*a. Purpose.* To insure efficient operation, it is necessary that the vehicle be systematically inspected at intervals every day it is operated and biweekly, so defects may be discovered and corrected before they result in serious damage or failure. Certain scheduled maintenance services will be performed at these designated intervals. All defects or unsatisfactory operating characteristics beyond the scope of the driver or operator(s) to correct must be reported at the earliest opportunity to the designated individual in authority.

*b. Services.* Driver's or operator's preventive maintenance services are listed in table II. Every organization must thoroughly school its personnel in performing the maintenance procedures for this vehicle as set forth in this manual.

Table II. Driver's or Operator's Preventive Maintenance Services

Interval S				Biweekly "B"	Procedure
Daily "A"					
Before operation	During operation	At halt	After operation		
X	-----	X	X	X	<b>Caution:</b> Place all tags describing condition of vehicle in the driver's compartment in a conspicuous location so that they will not be overlooked.
X	-----	-----	-----	X	<b>Fuel, oil, and water.</b> Check fuel, oil, and water levels. Check spare containers for contents. If water is added in cold weather, test solution with a hydrometer to determine if there is sufficient anti-freeze.
-----	-----	X	X	X	<b>Tires.</b> Gage tires for correct pressure (par. 248b).
X	-----	X	X	X	Remove penetrating objects such as nails or glass. Note any apparent loss of air, unusual wear, or missing valve caps.
X	-----	-----	-----	X	<b>Leaks, general.</b> Look under vehicle and in engine compartment for any indication of fuel, engine oil, water, or brake fluid leaks.
X	-----	-----	-----	-----	<b>Vehicle equipment.</b> Visually inspect fire extinguishers and vehicle publications, including Standard Form 91 and DD Form 518.

Table II. Driver's or Operator's Preventive Maintenance Services—Continued

Interval 8				Biweekly "B"	Procedure
Daily "A"					
Before operation	During operation	At halt	After operation		
				X	See that fire extinguishers are charged and sealed (if required).
X			X	X	Operate lights, horn (if tactical situation permits), and windshield wipers. Visually inspect mirrors, reflectors, body, towing connections, canvas items, tools, etc.
				X	Check for tampering or damage that may have occurred since last inspection.
X	X				<i>Instruments.</i> Observe for normal readings during warmup and during operation of vehicle.
					<i>Caution:</i> If it is necessary to add water to a radiator while the engine is overheated, run the engine at idling speed and slowly add the water. If oil pressure is zero or excessively low, shut off engine immediately and investigate cause (par. 81i).
	X				<i>General operation.</i> Be alert for any unusual noises or improper operation of steering, clutch, brakes, or gear shifting.
		X	X	X	<i>Operating faults.</i> Investigate and correct or report all faults noted during operation.
		X	X	X	<i>Springs and suspensions.</i> Look at springs and shock absorbers to see if they have been damaged.
			X	X	<i>Lubricate.</i> Lubricate items specified on lubrication chart (par. 69).
			X	X	<i>Clean.</i> Clean glass, vision devices, and inside of vehicle. Wipe off exterior of vehicle.
				X	Wash vehicle. Clean engine and engine compartment.
				X	<i>Battery.</i> Clean. Check water level. Inspect terminals for tightness and coating of grease (TM 9-2857).
				X	<i>Assemblies and belts.</i> Inspect assemblies such as carburetor, generator, starter, and water pump for looseness of mountings or connections. Test fan and generator drive belts to determine if tension is correct (par. 130a).
				X	<i>Electrical wiring.</i> Visually inspect, electrical wiring, conduits, and shielding.
				X	<i>Axle and transfer vents.</i> Inspect for clogging.

## 79. Organizational Mechanic or Maintenance Crew "C" and "D" Preventive Maintenance Services

*a. Intervals.* The indicated frequency of the prescribed preventive maintenance services is considered a minimum requirement for normal operation of vehicle. Under unusual operating conditions, such as extreme temperatures, dust or sand, or extremely wet terrain, it may be necessary to perform certain maintenance services more frequently.

*b. Driver or Operator Participation.* The drivers or operators should accompany vehicle and assist the mechanics while periodic organizational preventive maintenance services are performed. The driver should present the vehicle for a scheduled preventive maintenance service in a reasonably clean condition.

*c. Special Services.* These are indicated by the item numbers in the columns which show the interval at which the services are to be performed, and show that the parts or assemblies are to receive certain mandatory services. For example, an item number in one or both columns opposite a *tighten* procedure means that the actual tightening of the object must be performed. The special services are as shown below.

- (1) *Adjust.* Make all necessary adjustments in accordance with instructions contained in the pertinent section of this manual and appropriate technical bulletins.
- (2) *Clean.* Clean the unit as outlined in paragraph 77 to remove old lubricant, dirt, and other foreign material.
- (3) *Special lubrication.* This applies either to lubrication operations that do not appear on the vehicle lubrication chart or to items that do appear but which should be performed in connection with the maintenance operations if parts have to be disassembled for inspection or service.
- (4) *Serve.* This usually consists of performing special operations, such as replenishing battery water, draining and refilling units with oil, and changing or cleaning the oil filter, air cleaner, or cartridges.
- (5) *Tighten.* All tightening operations should be performed with sufficient wrench torque (force on the wrench handle) to tighten the unit according to good mechanical practice. Use a torque-indicating wrench where specified. Do not overtighten, as this may strip threads or cause distortion. Tightening will always be understood to include the correct installation of lockwasher, locknuts, locking wire, or cotter pins to secure the tightened nut.

*d. Special Conditions.* When conditions make it difficult to perform the complete preventive maintenance procedures at one time, they can sometimes be handled in sections. Plan to complete all operations within the week if possible. All available time at halts



and in bivouac areas must be utilized, if necessary, to assure that maintenance operations are completed. When limited by the tactical situation, items with special services in the columns should be given first consideration.

*e. DA Form 461.* The numbers of the preventive maintenance procedures that follow are identical with those outlined on DA Form 461. Certain items on the form that do not apply to this vehicle are not included in the procedures in this manual. In general, the sequence of items on the form is followed, but in some instances there is deviation for conservation of the mechanic's time and effort.

*f. Procedures.* Table III lists the services to be performed by the organizational mechanic or maintenance crew at the designated intervals. Each page of the table has two columns at its left edge for designated intervals of every 1,000 miles ("C" service) and 6 months or 6,000 miles whichever occurs first ("D" service). Very often it will be found that a particular procedure does not apply to both scheduled intervals. In order to determine which procedure to follow, look down the column corresponding to the maintenance procedure and wherever an item number appears, perform the operations indicated opposite the number.

*Table III. Organizational Mechanic or Maintenance Crew "C" and "D" Preventive Maintenance Services*

"C" (1,000 miles)	"D" (6 months or 6,000 miles)	Procedure
<b>INSPECTION AND ROAD TEST</b>		
<p><i>Note.</i> When the tactical situation does not permit a full road test, perform only those items that require little or no movement of the vehicle.</p>		
		<p><b>BEFORE OPERATION.</b> <i>Fuel, oil, water, antifreeze, tires, instruments, leaks, general visual inspection of vehicle and equipment.</i> Perform the before-operation service listed in table II.</p>
1	1	<p><i>Dash instruments, switches, and gages, oil pressure, ammeter, speedometer, temperature, fuel, ignition switch, and other controls.</i> Note generator output on the ammeter immediately after starting engine, before generator regulator has reduced the charging rate. Observe all instruments for normal readings. Notice if the ignition switch operates freely and makes positive contact, and check other controls for normal operation.</p>
2	2	<p><i>Horns, mirrors, and windshield wipers.</i> Sound horn to see if signal is normal (if tactical situation permits). Test windshield wipers for satisfactory operations. Examine mirrors and reflectors.</p>
3	3	<p><i>Engine-idle, acceleration, power, noise, governed speed.</i> In warming up the engine, observe if it starts easily and if action of choke and hand throttle are satisfactory. Note if idling speed is correct. Listen for unusual noises at idle and higher speeds.</p>

Table III. Organizational Mechanic or Maintenance Crew "C" and "D" Preventive Maintenance Services—Continued

"C" (1,000 miles)	"D" (6 months or 6,000 miles)	Procedure
INSPECTION AND ROAD TEST—Continued		
		<p>When operating the vehicle, note if it has normal power and acceleration. Listen for unusual noises when the engine is under load. Speed up the vehicle, on a level stretch, to see if it will reach the speed indicated on the speed caution plate.</p>
4	4	<p><i>Steering free play, bind, wander, shimmy, side pull, column and wheel.</i> With the vehicle moving straight ahead, see if the steering wheel has excessive free play and if there is a tendency to wander, shimmy, or pull to the side. Turn the steering wheel through its entire range and note any bind. Examine steering column and wheel.</p>
5	5	<p><i>Clutch free travel, drag, noise, chatter, grab, slip.</i> See if clutch pedal has specified free travel (par. 191a) and if action of pedal return spring is satisfactory. Note whether clutch disengages completely or has a tendency to drag. Observe smoothness of engagement and tendency to chatter, grab, or slip and any unusual noise. With transmission in neutral, depress and release clutch pedal, listening for defective release bearing.</p>
7	7	<p><i>Brakes (foot and hand)—braking effect, feel, side pull, noise, chatter, pedal travel, and hand control.</i> See if brake pedal has specified free travel (par. 233a(2)) and if action of return spring is satisfactory. Observe if pedal goes too close to floor. Make several stops noting side pull, noise, chatter, or other unusual condition. Observe if ratchet of hand brake holds and if the lever requires more than three-quarters travel for full application. Stop the vehicle on an incline and apply the brake to see if it holds the vehicle or if application of the brake at a speed of 10 mph stops the vehicle within a reasonable distance. Inspect ratchet and pawl.</p>
8	8	<p><i>Generator, starter and switch—action, noise, speed.</i> Notice if the starter engages smoothly without unusual noise and turns the engine with adequate cranking speed. Examine generator brushes and clean commutator.</p>
9	9	<p><i>Transmission and transfer—lever action, declutching, vibration, noise.</i> Shift transmission and transfer into all speeds, observing any unusual stiffness of the shift levers, tendency to slip out of speed, unusual noise, or excessive vibration. Make similar observations with the transfer front wheel drive lever.</p>
10	10	<p><i>Unusual noises—attachments, body and wheels, power train.</i> At all times during the road test, be alert for unusual or excessive noises that may indicate looseness, defects, or deficient lubrication in these components.</p>
11	11	<p><i>Lamps—head, tail, stop, blackout and instrument panel.</i> During stops in the road test, test the operation of these exterior and interior lights and light switches. Notice if headlights appear to be properly aimed. Note condition of lights and safety reflectors.</p>

Table III. Organizational Mechanic or Maintenance Crew "C" and "D" Preventive Maintenance Services—Continued

"C" (1,000 miles)	"D" (6 months or 6,000 miles)	Procedure
<b>AFTER ROAD TEST</b>		
25	25	<p><i>Temperatures—brake drums, hubs, axles, transmission, transfer, differentials.</i> Immediately after the road test, feel these units cautiously. An overheated wheel hub and brake drum indicates an improperly adjusted, defective, or dry wheel bearing or a dragging brake. An abnormally cool condition indicates an inoperative brake. An overheated gear case indicates internal maladjustment, damage, or lack of lubrication.</p> <p><i>Note.</i> It is normal for hypoid rear axles and transfers to run quite hot after the vehicle has run a considerable distance. If these particular units are too hot for the hand to be placed upon them, it is not necessarily a sign of malfunctioning. If they are adequately lubricated and did not howl during the road test, assume they are all right.</p>
-----	25	<p>Inspect propeller shafts. Tighten universal joint assembly and flange units.</p>
26	26	<p><i>Leaks—engine oil, fuel, water, axles, housings, transmission, transfer and all other components carrying fluids, oil, or grease.</i> Make general observations in the engine compartment and underneath the vehicle for oil, water, fuel, and exhaust leaks. Look at spark plug, manifold, and cylinder head gaskets.</p> <p><b>Caution:</b> Do not tighten the cylinder head or manifold unless there is evidence of looseness or leakage.</p> <p>If cylinder head requires tightening, use a torque-indicating wrench and tighten to a torque of 60–65 foot-pounds in the sequence illustrated in figure 48.</p>
27	27	<p><i>Lubrication—lubricate vehicle in accordance with lubrication chart (par. 69).</i> Coordinate with inspection and disassembly operations to avoid duplication.</p>
27	27	<p>During lubrication, inspect tires for unusual wear, penetrating objects, and proper matching.</p>
-----	27	<p>Rotate and match tires according to tread design and degree of wear. See TM 31–200 for acceptable limits in matching tires. Tighten axle flange nuts.</p>
<b>MAINTENANCE OPERATION</b>		
28	28	<p><i>Battery—specific gravity.</i> Make hydrometer test of electrolyte in each cell according to instruction in TM 9–2857 and record specific gravity in space provided on DA Form 461.</p>
29	29	<p><i>Battery—voltage.</i> Perform high-rate discharge test according to instruction in TM 9–2857 or accompanying test instrument. Record voltage of each cell in space provided on DA Form 461. After battery test, clean top of battery, coat terminals lightly with grease, repaint carrier if corroded. See if battery requires water.</p>

Table III. Organizational Mechanic or Maintenance Crew "C" and "D" Preventive Maintenance Services—Continued

"C" (1,000 miles)	"D" (6 months or 6,000 miles)	Procedure
MAINTENANCE OPERATION—Continued		
-----	30	<i>Compression.</i> Test compression (par. 106) in each cylinder, with throttle and choke wide open, and record in space provided on DA Form 461. It is preferable to make compression test with engine at operating temperature.
-----	31	<i>Breather caps and ventilators.</i> Inspect carburetor, breather, and crankcase-ventilator caps and air cleaners.
-----	31	Clean and service these items in accordance with lubrication chart (par. 69) or instructions in the pertinent sections of this manual.
-----	32	<i>Radiator—core, hose, cap and gasket.</i> Inspect these items, noticing particularly if the radiator core is clogged with foreign matter or if fins are bent. Test the operation of pressure cap. Observe coolant level and examine coolant for contamination. In cold weather, test coolant with a hydrometer to see if it contains sufficient antifreeze.
-----	32	If need is indicated, drain radiator and block, clean, flush, refill, and add inhibitor, unless antifreeze, which contains inhibitor, is used (TM 9-2858). Tighten radiator mounting and hose clamps.
-----	33	<i>Water pump, fan, drive belts, and pulleys.</i> Inspect pulleys and fan for alinement and belts for tension (par. 130a). Notice if water pump is leaking.
-----	34	<i>Valve mechanism—clearance, cover gaskets.</i> Gage valve tappet clearance and look for broken valve springs, low compression, or tappet noise. If clearance is insufficient, adjust, and recheck compression. Inspect cover gaskets.
-----	35	<i>Spark plugs—clean and adjust, distributor cap, rotor, points, shaft, advance units, coil and wiring, ignition timing.</i> Remove and inspect spark plugs (par. 153c). Inspect distributor cap, rotor, and breaker points and test operation of centrifugal and vacuum advance mechanisms by hand. Test distributor shaft for looseness by hand. Test ignition coil and distributor capacitor with high-tension ignition-circuit tester, if available, according to instructions accompanying test instrument. Using timing light, observe if ignition timing is correct (par. 149) and if spark advances automatically as engine is accelerated. Test generator regulator with low-voltage circuit tester following instructions accompanying test instrument.
-----	35	Clean spark plugs and adjust gaps (par. 153d). Dress distributor breaker points and adjust gaps (par. 151b(1)). If points are badly pitted, replace both points (par. 151b(2) and (3)) and capacitor (par. 151c).
-----	36	<i>Manifold.</i> Inspect this item. Look particularly for signs of leakage at the manifold gaskets.

Table III. Organizational Mechanic or Maintenance Crew "C" and "D" Preventive Maintenance Services—Continued

"C" (1,000 miles)	"D" (6 months or 6,000 miles)	Procedure
MAINTENANCE OPERATION—Continued		
37	37	<i>Carburetor, choke, throttle, linkage, and lines.</i> Inspect these items, noticing particularly if the shafts and linkage operate freely and are not excessively worn. Observe if the choke valve opens fully when the control is released and if the throttle valve opens fully when the accelerator is fully depressed.
-----	37	Make an engine vacuum test (par. 107) and adjust carburetor idle mixture. Test fuel pump pressure (par. 82a(5)).
-----	37	<i>Drain water and sediment from fuel tank if there is evidence of contamination, using a container to catch the drainings (par. 140a(1)).</i> Examine fuel lines and connections for evidence of leaks.
-----	38	<i>Exhaust pipe and muffler.</i> Inspect; listen for excessive or unusual noises and look for exhaust leaks.
-----	38	Tighten mountings.
-----	39	<i>Brake shoes—linings, links, guides, anchors, supports, cylinders, hose, and lines.</i> Inspect flexible brake lines and solid lines and test linkage for freedom of action. Remove wheels and hubs and examine brake drums, shoes, linings, links, guides, anchors, supports, retractor springs, and cylinders or cams. Clean and inspect hub bearings.
-----	39	Wheel bearings will be disassembled, cleaned, and repacked in every second 6,000-mile inspection or annually. If the hub bearings are due for repacking, remove wheels and hubs and make observations of the brake internal components as in the preceding paragraph. Clean the anchor plates and tighten the anchor plate bolts. If the hub bearings are not due for repacking, inspect the internal brake components. Adjust brakes. If wheels have not been disassembled from brake drums, tighten hub nuts.
-----	40	<i>Body—hardware, glass, top and frame, curtains and fasteners, seats, upholstery, trim, safety straps, and paint.</i> Inspect these items, paying particular attention to body mountings; include springs. Test operation of windshield, hood hinges, and fasteners. Observe seat mountings and upholstery. Make a general inspection of body, including glass, panels, tops, fenders, chains, bows, curtains, and grille. Examine condition of paint and legibility of markings and identification and caution plates.
-----	40	Tighten body mounting bolts. Loosen the steering column clamp before tightening body mounting bolts and tighten afterwards. Tighten spring U-bolts and rebound clips.
-----	42	<i>Bumpers—front and rear, towing pintle.</i> Inspect these items; include lifting shackles. Test operation of towing pintle.

## Section IV. TROUBLESHOOTING

### 80. Scope

a. This section contains troubleshooting information and tests for locating and correcting some of the troubles which may develop in the vehicle. Troubleshooting is a systematic isolation of defective components by means of an analysis of vehicle trouble symptoms; testing to determine the defective component and applying the remedies. Each symptom of trouble given for an individual unit or system is followed by a list of probable causes of the trouble and suggested procedures to be followed.

**Caution:** When using the substitution method of troubleshooting and the trouble is not immediately corrected by replacement of an item, reinstall the original unit before operating the vehicle.

b. This manual cannot cover all possible troubles and deficiencies that may occur under the many conditions of operation. If a specific trouble, test, and remedy therefor is not covered herein, proceed to isolate the system in which the trouble occurs and then locate the defective component. Do not neglect use of any test instruments such as voltmeter, ammeter, test lamp, hydrometer, and pressure and vacuum gages that are available (pars. 65 through 68). Standard automotive theories and principles of operation apply in troubleshooting the vehicle. Question vehicle driver or operator to obtain maximum number of observed symptoms. The greater the number of symptoms of troubles that can be evaluated, the easier will be the isolation of the defect.

### 81. Engine

#### a. *Engine Will Not Turn.*

(1) *Starter inoperative.* Refer to paragraph 85a.

(2) *Mechanical seizure of parts.* Remove spark plugs (par. 153c). Place a suitable socket wrench and extensions on the crankshaft pulley nut (fig. 152). Try to turn the engine in a clockwise direction. If engine cannot be turned, notify ordnance maintenance personnel.

#### b. *Engine Turns But Will Not Start.*

(1) *Insufficient fuel.* Fill the fuel tank with fuel.

(2) *Slow cranking speed (starter).* Refer to paragraph 85b.

(3) *Engine flooded.* Press accelerator pedal to floor and crank engine until it starts.

(4) *Carburetor choke control inoperative.* Remove the air intake hose at the carburetor. Pull choke control in driver's compartment all the way out. Look into the choke control body to make certain that choke control valve is fully closed. If

it is not fully closed, adjust the choke control assembly (par. 135i(1)).

*Note.* Make sure choke control valve is fully open when the choke control is pushed all the way in (par. 82c(2)).

- (5) *Ignition system inoperative.* Remove one spark plug cable and hold cable terminal one-quarter inch from cylinder head while cranking engine with starter. If spark does not jump the gap between the terminal and the cylinder head, the ignition system is inoperative. Refer to paragraph 84b.
- (6) *Fuel system inoperative.* Remove the fuel and vacuum pump-to-carburetor line from the carburetor (par. 142f(1)). With the ignition switch turned off, turn the engine with the starter. If a continuous flow of fuel is not evident, the fuel system is inoperative. Refer to paragraph 82a.
- (7) *Ignition timing incorrect.* Check the ignition timing and adjust if necessary (par. 149).
- (8) *Valve clearance incorrect.* Check the valve clearance and adjust if necessary (par. 110).
- (9) *Cylinder compression poor or uneven.* Perform cylinder compression test and follow corrective procedure outlined in paragraph 106.

*c. Engine Starts But Will Not Run.*

- (1) *Air cleaner restricted or dirty.* Service the air cleaner (par. 69).
- (2) *Fuel system inoperative.* Refer to b(6) above.
- (3) *Spark plugs dirty or incorrectly adjusted.* Remove spark plugs (par. 153c). Clean the plugs and set gaps to 0.030-inch. Replace worn out plugs (par. 153d).
- (4) *Distributor rotor damaged or improperly installed.* Remove the distributor cover and cap assembly (par. 151a(1)). Inspect the rotor to make certain it is properly installed and not damaged. Replace if necessary.
- (5) *Distributor cap damaged.* Remove the distributor cover and cap assembly (par. 151a(1)). Inspect the cap for damage or unusual oxidation. Replace cap if necessary (par. 151a(2)).
- (6) *Breaker point set improperly adjusted or damaged.* Check and adjust the breaker point set (par. 151b(1)). Check point set for signs of unusual burning or pitting. Replace if necessary (par. 151b(2) and (3)).

*d. Stalling or Uneven Idling Speed.*

- (1) *Idle speed adjustment incorrect.* Adjust carburetor to correct idle speed (par. 134a(2)).
- (2) *Idle fuel adjustment incorrect.* Correct carburetor idle fuel adjustment (par. 134a(1)).

- (3) *Spark plugs dirty or incorrectly adjusted.* Refer to *c*(3) above.
- (4) *Weak spark.* Remove one spark plug cable and hold cable terminal one-quarter inch from cylinder head while cranking the engine with starter. If spark is weak, refer to paragraph 84c.
- (5) *Cylinder compression poor or uneven.* Refer to *b*(9) above.
- (6) *Air cleaner restricted or dirty.* Service the air cleaner (par. 69).
- (7) *Carburetor choke control inoperative.* Refer to *b*(4) above.

*e. Engine Misfires.*

- (1) *Weak spark.* Refer to *d*(4) above.
- (2) *Spark plugs dirty or incorrectly adjusted.* Refer to *c*(3) above.
- (3) *Cylinder compression poor or uneven.* Refer to *b*(9) above.
- (4) *Sticking valves.* Perform manifold vacuum test and follow corrective procedure outlined in paragraph 107.

*f. Engine Does Not Develop Full Power.*

- (1) *Air cleaner restricted or dirty.* Service the air cleaner (par. 69).
- (2) *Accelerator pedal adjustment incorrect.* Check accelerator pedal adjustment and correct if necessary (par. 135a(1)).
- (3) *Spark plugs dirty or incorrectly adjusted.* Refer to *c*(3) above.
- (4) *Ignition timing incorrect.* Refer to *b*(7) above.
- (5) *Sticking valves.* Refer to *e*(4) above.
- (6) *Cylinder compression poor or uneven.* Refer to *b*(9) above.
- (7) *Incorrect grade of fuel.* Use gasoline with an octane rating of not less than 79.
- (8) *Preignition.* With engine at normal operating temperature (160° to 180° F.), rapidly accelerate vehicle in third gear. If the engine is preigniting, a ping or knock will be heard during part of the accelerating period. If correct grade of fuel is being used ((7) above), and the ignition system is functioning satisfactorily (par. 84), the spark plugs may be faulty or of improper heat range. Replace the spark plugs (par. 153c and d). If spark plug replacement does not correct the condition, notify ordnance maintenance personnel.
- (9) *Brakes drag.* After the vehicle has been driven a short distance, put the transmission in neutral, jack up the wheels one at a time and try to turn each wheel. If a drag is noticed on any wheel, refer to paragraph 98.



*g. Engine Overheats (Normal Operating Temperature 160° to 180° F.).*

- (1) *Cooling system faulty.* Refer to paragraph 88.
- (2) *Ignition timing incorrect.* Check the ignition timing and adjust if necessary (par. 149).
- (3) *Insufficient oil in crankcase.* Check level of oil in crankcase and fill if necessary (par. 69).

*h. Excessive Oil Consumption.*

- (1) *Leaks.* Inspect engine compartment and under front of vehicle for signs of engine oil leaks. Tighten leaking connections or replace damaged oil lines. If leak continues, notify ordnance maintenance personnel.
- (2) *Crankcase overfilled.* Maintain oil at correct level (par. 69).
- (3) *Operation at excessive high speeds.* Avoid unnecessary and excessively high speeds.
- (4) *Excessive low-range driving.* Operate vehicle in proper gear for desired speeds and terrain.
- (5) *Engine overheats.* Refer to *g* above.
- (6) *Cylinder compression poor or uneven.* Refer to *b*(9) above.

*i. Low Oil Pressure.* Check engine oil level and grade of oil (par. 69). If the crankcase is properly filled with oil of the correct grade, check the oil pressure gage (par. 90*d*). If oil pressure gage is operating correctly, low oil pressure is caused by worn engine parts. Notify ordnance maintenance personnel.

## **82. Fuel and Air Intake System**

*a. Fuel Does Not Reach Carburetor.*

- (1) *Fuel shutoff valve closed.* Make sure the fuel shutoff valve (Q, fig. 55) is in the OPEN position (valve handle parallel to line).
- (2) *Fuel tank empty.* Check fuel gage for level in fuel tank and refuel if necessary.
- (3) *Fuel filter clogged.* Remove the fuel filter assembly (par. 138*a*) and replace element (par. 139). Make sure connections are tight.
- (4) *Fuel line leak.* Check all fuel lines and fittings carefully for leaks (par. 142).
- (5) *Fuel pump pressure incorrect.* Disconnect fuel line from outlet side of fuel and vacuum pump. Install a pressure gage (fig. 35) in the fuel and vacuum pump outlet. With ignition switch turned off, crank engine with starter until the pointer on the pressure gage reaches a maximum reading. Fuel pump pressure should be between 4½ and 5 psi. If pressure is incorrect, replace the fuel and vacuum pump assembly (par. 137). If pressure of new pump is incorrect, notify ordnance maintenance personnel.

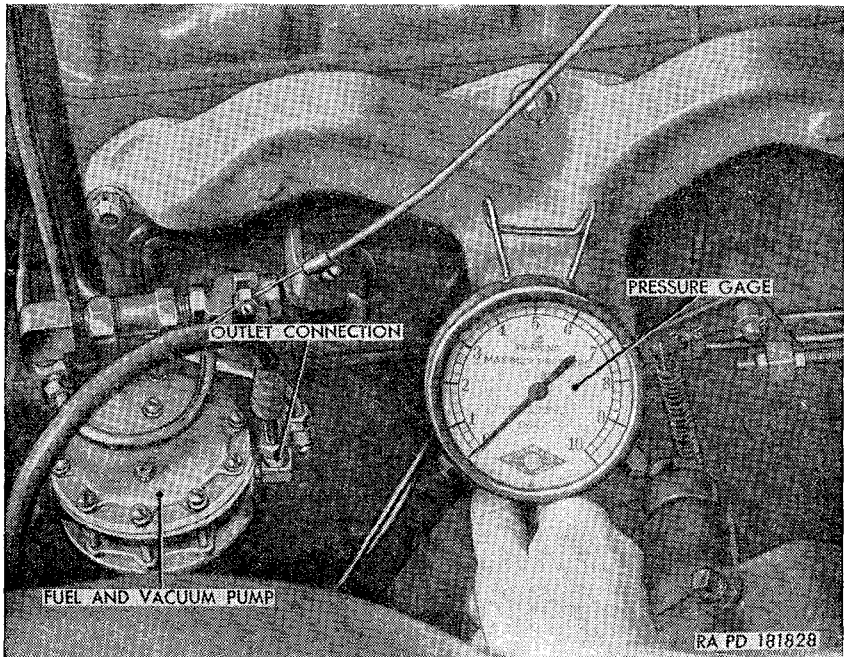

Figure 35. Testing fuel pump pressure.

(6) *Fuel lines clogged.* Disconnect fuel lines (par. 142) and blow out with compressed air.

b. *Fuel Does Not Reach Cylinders.* Disconnect fuel line (E, fig. 64) from inlet side of carburetor and crank engine with starter to make certain fuel is reaching carburetor. Connect fuel line to carburetor and disconnect the air intake hose at the top of the carburetor. Pour a small amount of fuel into the neck of the carburetor and try to start the engine. If the engine starts but stops quickly, fuel is not reaching the cylinders. Replace the carburetor (par. 134).

c. *Engine Floods.*

- (1) *Air cleaner restricted or dirty.* Service air cleaner (par 69).
- (2) *Carburetor choke control not fully open.* Remove the air intake hose (E, fig. 66) at the carburetor. Push the choke control in the driver's compartment all the way in. Look into the choke control body to make certain the choke control valve is fully open. If it is not fully open, adjust the choke control assembly (par. 135i(1)).
- (3) *Fuel pump pressure incorrect.* Refer to a(5) above.
- (4) *Carburetor adjustment incorrect.* Adjust carburetor (par. 134a).
- (5) *Worn carburetor.* If engine continues to flood after (1) through (4) above have been checked, replace the carburetor (par. 134).

*d. Excessive Fuel Consumption.*

- (1) *Leaks.* Carefully inspect all fuel lines and fittings for leaks. Tighten or replace damaged lines or fittings (par. 142).
- (2) *Carburetor choke control not fully open.* Refer to *c*(2) above.
- (3) *Carburetor adjustment incorrect.* Adjust carburetor (par. 134a).
- (4) *Air cleaner restricted or dirty.* Service air cleaner (par. 69).
- (5) *Weak spark.* Remove one spark plug cable and hold cable terminal one-quarter inch from cylinder head while cranking the engine with starter. If spark is weak, refer to paragraph 84c.
- (6) *Spark plugs dirty or incorrectly adjusted.* Remove the spark plugs (par. 153c). Clean the plugs and set gaps to 0.030-inch. Replace worn out plugs (par. 153d).
- (7) *Fuel pump pressure incorrect.* Refer to *a*(5) above.
- (8) *Ignition timing incorrect.* Check the ignition timing and adjust if necessary (par. 149).
- (9) *Valve adjustment incorrect.* Perform manifold vacuum test and follow corrective procedure outlined to paragraph 107.
- (10) *Brakes drag.* Refer to paragraph 81f(9).
- (11) *Cylinder compression poor or uneven.* Perform cylinder compression test and follow corrective procedure outlined in paragraph 106.

## 83. Exhaust System

*a. Unusual Noise.*

- (1) *Exhaust muffler broken.* Inspect the exhaust muffler for breaks or cracks. If muffler is damaged, replace it (par. 144).
- (2) *Loose connections or broken gaskets.* Inspect the exhaust system (par. 143) for broken brackets or leaking gaskets. Replace damaged parts as required.
- (3) *Exhaust pipe or exhaust pipe extension broken.* Check the exhaust pipe and exhaust pipe extension for breaks and replace, if necessary (pars. 145 and 146).

*b. Odor of Exhaust Fumes in Driver's Compartment.*

**Warning:** If exhaust fumes are noted in driver's compartment, carefully inspect all parts of the exhaust system and replace faulty or damaged parts immediately. Carbon monoxide (a colorless gas), found in exhaust fumes, is poisonous.

## 84. Ignition System

*a. General.* To isolate the ignition system as a source of trouble, attempt to start the engine. If the starter is inoperative or the cranking speed is excessively slow, refer to paragraph 85a or *b*. If this does not isolate the trouble, remove one spark plug cable and hold the

cable terminal one-quarter inch from the cylinder head while cranking the engine with the starter. If there is no spark, refer to *b* below. If the spark is weak, refer to *c* below.

*b. No Spark.*

- (1) *Battery cables loose.* Clean terminals (fig. 99) and make certain all connections are tight.
- (2) *Ignition switch inoperative.* Refer to figure 75 and make a continuity check of the voltage supply through the ignition switch. If suitable equipment for checking continuity is not available, check by replacing the ignition switch (par. 181) with one known to be operating.
- (3) *Primary capacitor open or shorted.* Remove the distributor cover and cap assembly (par. 151a(1)). Disconnect the ignition coil primary cable from the coil. With the ignition switch on, momentarily ground the cable terminal. If no spark results, a break in the line from the switch to the capacitor or a faulty capacitor is indicated. Remove the primary capacitor (par. 151d(1)). Check the capacitor with suitable test equipment, or replace with one known to be working (par. 151d(2)). If a break in the line is indicated, notify ordnance maintenance personnel.
- (4) *Ignition coil inoperative.* Remove the ignition coil (par. 152a). Check the coil with suitable test equipment or replace with one known to be operating (par. 152b).
- (5) *Breaker point capacitor inoperative.* Remove the breaker point capacitor (par. 151c(1)). Check the capacitor with suitable test equipment, or replace with one known to be operating (par. 151c(2)).
- (6) *Breaker point set improperly adjusted or damaged.* Check and adjust the breaker point set (par. 151b(1)). Check point set for signs of unusual burning or pitting. Replace if necessary.
- (7) *Distributor cap damaged.* Remove the distributor cover and cap assembly (par. 151a(1)). Inspect cap for damage or unusual oxidation. Replace cap if necessary (par. 151a(2)).
- (8) *Distributor rotor damaged or improperly installed.* Remove the distributor cover and cap assembly (par. 151a(1)). Inspect rotor for proper installation and for damage. Replace if necessary (par. 151b(1)).
- (9) *Broken cables.* If there is no spark after (1) through (8) above have been checked, notify ordnance maintenance personnel.

*c. Weak Spark.*

- (1) *Loose connections.* Check all connections in the ignition system (par. 147a) and tighten if necessary.

- (2) *Distributor worn.* Remove the distributor cover and cap assembly (par. 151a(1)). Check the rotor and cam for side play or wear. If parts are sufficiently worn to cause uneven breaker point opening, replace the distributor (par. 150).
- (3) *Ignition coil inoperative.* Refer to b(4) above.
- (4) *Breaker point capacitor faulty.* Refer to b(5) above.
- (5) *Breaker point set improperly adjusted or damaged.* Refer to b(6) above.

## 85. Starting System

### a. Starter Inoperative.

- (1) *Batteries weak or discharged.* Refer to TM 9-2857.
- (2) *Battery cables loose or disconnected.* Clean terminals and make certain all connections are tight (par. 162b).
- (3) *Loose connection.* Check all connections in the starting system and tighten if necessary (pars. 155 and 156).
- (4) *Starter switch inoperative.* Replace starter switch (par. 156) with one known to be operating.
- (5) *Starter inoperative.* If starter is inoperative after (1) through (4) above have been checked, replace the starter assembly (par. 155).
- (6) *Mechanical seizure of parts.* Refer to paragraph 81a(2).

### b. Slow Cranking Speed.

- (1) *Batteries weak or discharged.* Refer to TM 9-2857.
- (2) *Battery cables loose or disconnected.* Refer to a(2) above.
- (3) *Loose connections.* Refer to a(3) above.
- (4) *Incorrect oil viscosity.* Inspect oil. If, of improper grade, drain crankcase and refill with correct grade of oil (par. 69).
- (5) *Starter assembly inoperative.* If starting speed is still slow after (1) through (4) above have been checked, replace the starter assembly (par. 155).

### c. Starter Operation Noisy.

- (1) *Starter supports loose.* Check the mounting bolts in the starter support and tighten if necessary.
- (2) *Starter worn.* If noise originates from within the starter, replace the starter assembly (par. 155).

## 86. Generating System

a. *General.* Before attempting to isolate trouble in the generating system, test the batteries (TM 9-2857). If batteries are not fully charged, and a low charging rate is indicated by the ammeter, refer to b below. If the batteries are fully charged, and a high charging rate is indicated by the ammeter, refer to c below.

### b. Low Charging Rate Indicated With Batteries Not Fully Charged.

- (1) *Fan and generator drive belt set loose.* Adjust the tension (par. 130a).

- (2) *Battery terminals loose or corroded.* Clean terminals and tighten bolts. Refer to TM 9-2857.
  - (3) *Generator regulator inoperative.* Replace the generator regulator assembly with one known to be operating (par. 159 or 160).
  - (4) *Generator inoperative.* If trouble has not been corrected after (1), (2), and (3) above have been checked, replace the generator assembly (par. 158).
  - (5) *Ammeter inoperative.* Check ammeter by replacing with one known to be operating (par. 174).
- c. High Charging Rate Indicated With Batteries Fully Charged.*
- (1) *Battery terminals loose or corroded.* Refer to *b*(2) above.
  - (2) *Generator regulator inoperative.* Refer to *b*(3) above.
- d. Generator Operation Noisy.*
- (1) *Fan and generator drive belt set too tight.* Adjust the tension (par. 130a).
  - (2) *Generator mounting loose.* Tighten the generator mounting bolts.
  - (3) *Generator inoperative.* If noise originates from within the generator, replace the generator assembly (par. 158).

## 87. Batteries and Lighting System

*a. General.* When checking the batteries and lighting system, refer to figure 95 for circuit continuity. The most common causes of light failure are faulty lamps, grounded or shorted cables, or discharged batteries. For testing and maintenance of batteries, refer to TM 9-2857.

### *b. Batteries Discharged.*

- (1) *Operation of electrical units without generator operating (engine not running).* When possible, avoid the use of electrical equipment with the engine stopped.
- (2) *Battery terminals loose or corroded.* Clean and tighten the battery terminals (fig. 99). Refer to TM 9-2857.
- (3) *Generator regulator inoperative.* Replace the generator regulator with one known to be operating (par. 159 or 160).
- (4) *Generator inoperative.* Replace the generator assembly with one known to be operating (par. 158).
- (5) *Battery inoperative.* Refer to TM 9-2857.

### *c. All Lights Fail.*

- (1) *Batteries discharged.* Refer to *b* above.
- (2) *Cables grounded or shorted.* Check continuity of cables (par. 171). If wiring is faulty, refer to ordnance maintenance personnel.
- (3) *Light switch inoperative.* Replace light switch with one known to be operating (par. 182).

*d. One Light Fails.*

- (1) *Lamp unit inoperative.* Replace lamp unit (par. 166a).
- (2) *Lamp assembly not properly grounded.* Tighten and clean all connecting screws or bolts.
- (3) *Loose connections.* Check and tighten all connections.
- (4) *Damaged wiring.* Check continuity of wiring. If wiring is damaged, refer to ordnance maintenance personnel.

*e. Insufficient Light.*

- (1) *Partially discharged battery.* Refer to *b* above.
- (2) *Loose connections.* Check and tighten all connections.
- (3) *Lenses dirty.* Clean lenses.

*f. Frequent Lamp Unit Failure.*

- (1) *Generator regulator inoperative.* Refer to *b*(3) above.
- (2) *Loose connections.* Check and tighten all connections.

*g. Stoplight Inoperative.*

- (1) *Lamp unit inoperative.* Replace lamp unit (par. 166a).
- (2) *Stoplight switch inoperative.* Replace stop light switch with one known to be operating (par. 186).
- (3) *Light switch inoperative.* Replace the light switch with one known to be operating (par. 182).
- (4) *Damaged wiring.* Refer to *d*(4) above.

## **88. Cooling System**

*a. General.* Normal operating temperature is between 160° and 180° F. If the water temperature gage falls below 140° F., or rises above 200° F., stop the engine and investigate the cause.

*b. Engine Overheats.*

- (1) *Insufficient coolant.* Make certain that radiator is filled with coolant to a level one inch below the bottom of the filler neck. If continued loss of coolant is indicated, refer to *d* below.
- (2) *Fan and generator drive belt set loose.* Adjust the tension (par. 130a).
- (3) *Radiator clogged.* Clean the cooling system in accordance with directions in TM 9-2858.
- (4) *Radiator air passages restricted.* Check radiator for obstructions. Use compressed air to blow dirt from air passages of radiator.
- (5) *Ignition timing incorrect.* Check the ignition timing and adjust if necessary (par. 149).
- (6) *Incorrect carburetor fuel and air adjustment.* Adjust carburetor fuel air mixture (par. 134 a(1)).
- (7) *Water pump inoperative.* Check water pump for external leaks or noisy operation. Replace water pump (par. 131) if necessary.
- (8) *Water temperature thermostat inoperative.* Replace thermostat (par. 132) with one known to be operating.

- (9) *Water temperature gage inoperative.* Replace water temperature gage (par. 176) with one known to be operating.
  - (10) *Water temperature sending unit inoperative.* Replace water temperature sending unit with one known to be operating (par. 188).
  - (11) *Water passages in engine obstructed.* If engine continues to overheat after (1) through (10) above have been checked, notify ordnance maintenance personnel.
- c. Engine Fails to Reach Normal Operating Temperature.*
- (1) *Water temperature thermostat inoperative.* Refer to *b*(8) above.
  - (2) *Water temperature gage inoperative.* Refer to *b*(9) above.
  - (3) *Water temperature sending unit inoperative.* Refer to *b*(10) above.
- d. Loss of Coolant.*
- (1) *External leaks.* Fill cooling system and run engine at idling speed. Inspect radiator, radiator hose, water pump, and all connections for leaks. Tighten connections or replace leaking units.
  - (2) *Internal leaks.* To detect internal leaks, proceed as follows: Remove the water temperature thermostat (par. 132*a*). Remove the fan and generator drive belt set (par. 130*b*). Fill the cylinder head with coolant. With the transmission in neutral, start the engine and accelerate rapidly several times. Bubbles in the coolant indicate leaks in the cylinder head gasket, or cracks in the cylinder head or block. Replace the cylinder head gasket (par. 111). If internal leaks are still indicated, notify ordnance maintenance personnel.

## 89. Horn

*a. Horn Does Not Sound.*

- (1) *Batteries discharged.* Refer to paragraph 87*b*.
- (2) *Horn disconnected.* Check the connections at the horn switch (par. 185) and at the horn (par. 184) for proper cable connections. Refer to figure 110 and check the continuity of the circuit.
- (3) *Horn switch inoperative.* Replace the horn switch with a switch known to be operating (par. 185).
- (4) *Horn inoperative.* Replace the horn with one known to be operating (par. 184).

*b. Horn Sounds Continuously.* If the horn sounds continuously, the horn switch is inoperative. Refer to *a*(3) above.



## 90. Instruments, Gages, Switches, and Sending Units

### a. *Ammeter Inoperative or Reads Incorrectly.*

- (1) *Generating system inoperative.* Refer to paragraph 86.
- (2) *Ammeter disconnected.* Make certain ammeter connections are tight (par. 174).
- (3) *Ammeter inoperative.* Refer to paragraph 86b(5).
- (4) *Ammeter reads backward.* Check the polarity of the batteries (par. 162a(8)). Ammeter connections reversed; check table IV, circuit Nos. 8 and 9 (par. 171).
- (5) *Damaged wiring.* Refer to paragraph 171.

### b. *Fuel Level Gage Fails to Register Correct Fuel Level.*

- (1) *Fuel level gage inoperative.* Replace fuel level gage with one known to be operating (par. 175).
- (2) *Fuel level sending unit inoperative.* Replace fuel level sending unit with one known to be operating (par. 189).
- (3) *Damaged wiring.* Refer to paragraph 171.

### c. *Engine Water Temperature Gage Apparently Registers Incorrectly.*

- (1) *Cooling system inoperative.* Refer to paragraph 88.
- (2) *Engine water temperature gage inoperative.* Refer to paragraph 88b(9).
- (3) *Engine water temperature sending unit inoperative.* Refer to paragraph 88b(10).
- (4) *Damaged wiring.* Refer to paragraph 171.

### d. *Engine Oil Pressure Gage Fails to Register.*

- (1) *Check oil level and grade* (par. 69).
- (2) *Damaged wiring.* Refer to paragraph 171.
- (3) *Engine oil pressure gage inoperative.* Replace oil pressure gage with one known to be operating (par. 177).
- (4) *Engine oil pressure sending unit inoperative.* Replace engine oil pressure sending unit with one known to be operating (par. 187).
- (5) *Engine oil pressure system inoperative.* If oil pressure gage fails to register after (1) through (4) above have been checked, notify ordnance maintenance personnel.

**Caution:** Do not continue to run the engine if insufficient or no oil pressure is indicated.

### e. *Speedometer Inoperative.*

- (1) *Speedometer flexible shaft core broken.* Replace the speedometer flexible shaft core (par. 178c).
- (2) *Speedometer inoperative.* Replace the speedometer (par. 178a and b).

### f. *Ignition Switch Fails to Operate.*

- (1) *Damaged wiring.* Refer to paragraph 171.

- (2) *Ignition switch inoperative.* Replace ignition switch with one known to be operating (par. 181).
- g. Light Switch Fails to Operate.*
- (1) *Damaged wiring.* Refer to paragraph 171.
- (2) *Light switch inoperative.* Replace light switch with one known to be operating (par. 182).
- h. Headlight Dimmer Switch Fails to Operate.*
- (1) *Damaged wiring.* Refer to paragraph 171.
- (2) *Headlight dimmer switch inoperative.* Replace headlight dimmer switch with one known to be operating (par. 183).
- i. Stoplight Switch Fails to Operate.*
- (1) *Damaged wiring.* Refer to paragraph 171.
- (2) *Stoplight switch inoperative.* Replace the stoplight switch with one known to be operating (par. 186).

## **91. Radio Interference Suppression System**

*a. General.* To locate the source of radio interference in a vehicle, the use of a radio receiver is required. With the vehicle at least 100 feet from any other vehicle and with the engine turned off, turn the radio on. Any noise heard on the receiver will be from an outside source. Start the engine and drive the vehicle, keeping at least 100 feet away from other vehicles. Any additional noise heard on the receiver will be from the vehicle itself.

*b. Isolating Source of Interference Originating from Vehicle.*

- (1) Operate the engine with the vehicle not in motion and listen for noises in the radio receiver. If a crackling or clicking noise is heard, accelerate the engine and turn off the ignition with the engine running at high speed. If the noise stops immediately, the source of interference is the ignition system (*c* below). If an irregular clicking or chattering continues for a few seconds after the ignition is turned off, the source of interference is in the generating system (*d* below). If a whining or whirring noise is heard, accelerate the engine and turn off the ignition with the engine running at high speed. If the tone lowers in pitch but continues for a few seconds after the ignition is turned off, the source of the interference is the generator (*d* below).
- (2) Operate the vehicle and note whether there is a clicking or scratching noise in the receiver. Stop the vehicle but leave the engine running. If the noise stops when the vehicle is stopped, the source of interference is loose cable connections or faulty vehicle wiring. Refer to *e* below.

*c. Ignition System Sources of Interference.* Make certain the ignition system is operating correctly (par. 84). Incorrect spark plug gaps, distributor breaker point set adjustment, or worn parts

will affect the suppression system. Clean and tighten all electrical connections. Tighten the engine mountings. Disconnect the cable from one spark plug at a time and start the engine. If interference is eliminated or reduced, replace the defective spark plug (par. 153c and d).

*d. Generating System Sources of Interference.* Check the generator regulator mounting bracket bolts and tighten if necessary. Check wiring harness connecting generator to generator regulator for broken or damaged insulation. Replace generator (par. 158) or generator regulator (par. 159 or 160), if necessary.

*e. Vehicle Wiring Damaged.* Inspect all wiring for frayed or otherwise damaged insulation. Replace if necessary. Clean and tighten all connections.

## 92. Clutch

*a. General.* Run the engine at idling speed. Depress the clutch pedal to fully released position long enough to let the clutch disk stop rotating. Shift the transmission into low or reverse gear. If shift cannot be made without severe gear clashing, or if there is a vehicle movement with the clutch fully released, the clutch is dragging. Refer to *b* below. With the engine idling, depress the clutch pedal to release the clutch and shift the transmission into high gear. Apply the hand brake and service brakes fully. Slowly engage the clutch. If the engine continues to run with the clutch fully engaged, the clutch is slipping. Refer to *c* below.

*b. Clutch Drags.*

- (1) *Clutch pedal free travel excessive.* Adjust the clutch linkage (par. 191).
- (2) *Clutch worn or damaged.* If clutch continues to drag after the clutch pedal free travel has been adjusted, notify ordnance maintenance personnel.

*c. Clutch Slipping.*

- (1) *Clutch pedal free travel insufficient.* Adjust clutch linkage (par. 191).
- (2) *Clutch worn or damaged.* If clutch continues to slip after the clutch pedal free travel has been adjusted, notify ordnance maintenance personnel.

*d. Clutch Noisy in Operation.*

- (1) *Clutch linkage incorrectly adjusted.* Adjust clutch linkage (par. 191).
- (2) *Loose connections.* Check the tightness of the engine rear supports, transmission mountings, and universal joints. Tighten as necessary.
- (3) *Clutch worn or damaged.* If clutch continues to be noisy in operation after (1) and (2) above have been checked, notify ordnance maintenance personnel.

*e. Clutch Pedal Pressure Unusually Stiff.*

- (1) *Insufficient lubrication.* Lubricate the clutch linkage (par. 69).
- (2) *Clutch worn or damaged.* If clutch pedal continues to be unusually stiff after lubrication, notify ordnance maintenance personnel.

### **93. Transmission**

*a. Transmission Will Not Shift Into Gear.*

- (1) *Incorrect lubricant.* If condition occurs in extreme cold weather, transmission lubricant may be of incorrect viscosity. Drain transmission and refill with correct lubricant (par. 69).
- (2) *Clutch linkage incorrectly adjusted.* Adjust clutch linkage (par. 191).
- (3) *Clutch worn or damaged.* Refer to paragraph 92.
- (4) *Transmission worn or damaged.* Replace transmission (pars. 195 and 196).

*b. Transmission Slips Out of Gear.* Refer to ordnance maintenance personnel.

*c. Transmission Noisy in Operation.*

- (1) *Insufficient lubrication.* Check the transmission lubricant level and fill if necessary (par. 69).
- (2) *Transmission worn or damaged.* Replace transmission (pars. 195 and 196).
- (3) *Transfer worn or damaged.* Unusual noises apparently in the transmission may sometimes be caused by a faulty transfer. If noise is noticed only when transfer is engaged, refer to paragraph 94d.

*d. Transmission Leaks Lubricant.*

- (1) *Drain plug loose or damaged.* Tighten or replace drain plug.
- (2) *Mounting connections loose.* Tighten mounting connections.
- (3) *Oil seals or gaskets damaged.* Refer to ordnance maintenance personnel.

### **94. Transfer**

*a. Transfer Will Not Shift Into Gear.*

- (1) *Incorrect lubricant.* If condition occurs during extreme cold weather, transfer lubricant may be of incorrect viscosity. Drain transfer and refill with correct lubricant (par. 69).
- (2) *Transfer worn or damaged.* Replace the transfer assembly (pars. 199 and 200).

*b. Transfer Will Not Disengage.* If transfer will not disengage while in front wheel drive position, stop the vehicle. Depress the clutch pedal and shift the transmission into reverse gear. Release

the clutch and back the vehicle a few feet. Depress the clutch pedal and release the transfer from front wheel drive.

*c. Transfer Slips Out of Gear.* Notify ordnance maintenance personnel.

*d. Transfer Noisy in Operation.*

(1) *Insufficient lubrication.* Check the transfer lubricant level and fill as necessary (par. 69).

(2) *Incorrect lubricant.* Make certain that lubricant is of correct grade (par. 69).

(3) *Transfer worn or damaged.* Replace transfer assembly (pars. 199 and 200).

*e. Transfer Leaks Lubricant.*

(1) *Drain plug loose or damaged.* Tighten or replace drain plug.

(2) *Loose mounting bolts.* Tighten all mounting bolts.

(3) *Damaged oil seal or gasket.* Refer to ordnance maintenance personnel.

## 95. Propeller Shafts With Universal Joint Assemblies

*a. Unusual Vibration.*

(1) *Foreign material on propeller shaft.* Check propeller shafts for tar or other foreign material that might throw shaft out of balance.

(2) *Propeller shaft bent.* Check propeller shafts for bends or dents. Replace propeller shafts with universal joint assemblies (pars. 202 and 203) if necessary.

(3) *Loose U-bolts.* Tighten or replace U-bolts.

*b. Backlash.*

(1) *Universal joint assemblies worn.* Turn propeller shaft by hand to detect unusual looseness in universal joint assemblies. If universal joints are worn, replace them (par. 204).

(2) *Loose U-bolts.* Tighten or replace U-bolts.

## 96. Front Axle

*a. Hard Steering.*

(1) *Insufficient lubrication.* Lubricate the front axle and steering system (par. 69).

(2) *Steering knuckle flange bearings incorrectly adjusted.* Disconnect the steering knuckle flange arm from the tie rod end. Check and adjust the steering knuckle flange bearings (par. 213c(5)).

(3) *Steering system worn or damaged.* Refer to paragraph 102.

*b. Front End Shimmy.*

(1) *Steering system worn or damaged.* Refer to paragraph 102.

(2) *Wheel damaged.* Refer to paragraph 100.

(3) *Front hub bearings worn or incorrectly adjusted.* Adjust bearings or replace if necessary (par. 208).

c. *Vehicle Wanders.*

(1) *Steering system worn or damaged.* Refer to paragraph 102.

(2) *Front hub bearings worn or incorrectly adjusted.* Adjust bearings or replace if necessary (par. 208).

(3) *Axle shifted.* Check alinement of axle and springs. If spring center bolt is broken, notify ordnance maintenance personnel.

d. *Unusual Noise.*

(1) *Insufficient lubrication.* Check the front axle lubrication and fill if necessary (par. 69).

(2) *Front hub bearings worn or incorrectly adjusted.* Adjust bearings or replace if necessary (par. 208).

(3) *Front axle worn or damaged.* If noise persists after (1) and (2) above have been checked, notify ordnance maintenance personnel.

e. *Front Axle Leaks Lubricant.*

(1) *Drain plugs loose or damaged.* Tighten or replace drain plugs.

(2) *Steering knuckle flange oil seals damaged.* Replace the steering knuckle flange oil seals (par. 212).

(3) *Axle housing damaged or cover gasket leaking.* Notify ordnance maintenance personnel.

## 97. Rear Axle

a. *Unusual Noise.*

(1) *Insufficient lubrication.* Check the rear axle lubrication and fill if necessary (par. 69).

(2) *Tires underinflated or damaged.* Refer to paragraphs 248b and 249b.

(3) *Propeller shaft loose or damaged.* Refer to paragraph 95.

(4) *Rear axle worn or damaged.* If noise persists after (1), (2), and (3) above have been checked, notify ordnance maintenance personnel.

b. *Axle Leaks Lubricant.*

(1) *Drain plugs loose or damaged.* Tighten or replace drain plugs.

(2) *Oil seals damaged.* Replace oil seals (par. 218).

(3) *Axle housing damaged or cover gasket leaking.* Notify ordnance maintenance personnel.

## 98. Service Brakes

**Caution:** Make certain the service brakes are adjusted and operating correctly after making any tests or repairs on the brake system.

*a. Service Brake Pedal Depresses to Floor.*

- (1) *Insufficient hydraulic fluid.* Check level of hydraulic fluid in brake master cylinder and fill if necessary (par. 234a).
- (2) *Brakes require adjustment.* Adjust the service brakes (par. 233b).
- (3) *Brake linings worn.* Replace the brake shoe with linings assembly (par. 233c and d).
- (4) *Service brake pedal free travel adjustment incorrect.* Check and adjust the service brake pedal free travel (par. 233a).

*b. Service Brake Pedal Action Soft.* Bleed the brakes (par. 237) to remove air from the brake lines.

*c. All Brakes Drag.*

- (1) *Brakes require adjustment.* Adjust the service brakes (par. 233b).
- (2) *Service brake pedal free travel adjustment incorrect.* Check and adjust the service brake pedal free travel (par. 233a).
- (3) *Mineral oil in hydraulic brake fluid.* Bleed brakes (par. 237) and refill with correct hydraulic brake fluid (par. 69). If this does not correct the trouble, notify ordnance maintenance personnel.

*d. One Brake Drags.*

- (1) *Dragging brake requires adjustment.* Adjust the dragging brake (par. 233b).
- (2) *Shoe retracting spring weak or broken.* Remove the brake drum (par. 209a) and inspect the shoe retracting spring. Replace spring if necessary (par. 233c(3) and d(5)).
- (3) *Inoperative wheel cylinder or clogged line.* Bleed the line to the dragging brake (par. 237). If fluid flows freely from the bleeder valve, the wheel cylinder is faulty. Replace the wheel cylinder (par. 235). If fluid does not flow freely from the bleeder valve, the line is clogged. Notify ordnance maintenance personnel.

*e. Brakes Grab.*

- (1) *Brakes require adjustment.* Adjust the service brakes (par. 233b).
- (2) *Oil, grease, or hydraulic fluid on linings.* Remove brake drum (par. 209a) and inspect brake parts for signs of oil, grease or hydraulic fluid. Check oil and grease seals for leaks and replace if necessary (pars. 211 and 218). If wheel cylinder is leaking, replace wheel cylinder (par. 235). If linings are soaked with oil, grease, or hydraulic fluid, replace brake shoe with linings assembly (par. 233c and d).

## 99. Hand Brake

### a. *Hand Brake Does Not Hold.*

- (1) *Hand brake adjustment incorrect.* Check and adjust the hand brake (par. 238a).
- (2) *Brake linings worn.* Replace the brake shoe with linings assembly (par. 238b and c).

### b. *Hand Brake Drags or Overheats.*

- (1) *Hand brake partially applied while vehicle is in motion.* Make certain hand brake is fully released before placing vehicle in motion.
- (2) *Hand brake adjustment incorrect.* Check and adjust the hand brake (par. 238a).

## 100. Wheels and Tires

### a. *Excessive or Uneven Tire Wear.*

- (1) *Unequal tire pressure.* Make certain all tires are inflated to the correct pressure (par. 248b).
- (2) *Front wheel alinement incorrect.* Check and adjust toe-in if necessary (par. 224). If toe-in adjustment does not correct the alinement trouble, notify ordnance maintenance personnel.
- (3) *Wheel bent.* Inspect wheels for out-of-round, dents, or damage to rims. Replace wheels if necessary (par. 250).
- (4) *Hub bearings worn or incorrectly adjusted.* Adjust bearings or replace if necessary (par. 208).

### b. *Wheel Wobbles.*

- (1) *Wheel bent.* Refer to a(3) above.
- (2) *Wheel loose.* Tighten hub nuts.
- (3) *Hub bearings worn or improperly adjusted.* Refer to a(4) above.

### c. *Wheel Pounds.*

- (1) *Damaged or uneven tires.* Refer to TM 31-200.
- (2) *Wheel bent.* Refer to a(3) above.
- (3) *Hub bearings worn or improperly adjusted.* Refer to a(4) above.
- (4) *Other causes.* If wheel continues to pound after (1) through (3) above have been checked, notify ordnance maintenance personnel.

## 101. Springs and Shock Absorbers

### a. *Hard Riding.*

- (1) *Insufficient lubrication.* Lubricate shackles (par. 69).
- (2) *Spring shackles frozen or too tight.* Remove, clean, and install the spring shackles (par. 242 or 243).



(3) *Shock absorber inoperative.* Disconnect and test the shock absorber action. If shock absorber is inoperative, replace (par. 247).

**b. Excessive Flexibility.**

(1) *Shock absorber inoperative.* Refer to *a*(3) above.

(2) *Spring leaves broken.* Inspect the springs for broken leaves. If leaves are broken, replace the spring (par. 245 or 246).

**c. Vehicle Sags to One Side.**

(1) *Improper load distribution.* Equalize wheel loading if possible.

(2) *Underinflated tire.* Inflate tires to correct pressure (par. 248b).

(3) *Weak spring.* Replace weak spring (par. 245 or 246).

(4) *Spring leaves broken.* Refer to *b*(2) above.

**d. Unusual Spring Noises.**

(1) *Insufficient lubrication.* Lubricate springs and shackles (par. 69).

(2) *Pivot bolts or shackles worn.* Check pivot bolts and shackles for wear and replace if necessary (pars. 242 and 244).

(3) *Shock absorber inoperative.* Refer to *a*(3) above.

## 102. Steering System

**a. Hard Steering.**

(1) *Insufficient lubrication.* Lubricate steering system (par. 69).

(2) *Underinflated tires.* Inflate tires to correct pressure (par. 248b).

(3) *Steering gear incorrectly adjusted.* Adjust the steering gear assembly (par. 230a).

(4) *Steering gear damaged.* Disconnect the drag link from the pitman arm (par. 227a(2)). If unusual noise or binding cannot be eliminated by adjustment ((3) above), notify ordinance maintenance personnel.

(5) *Steering knuckle flange bearings incorrectly adjusted.* Disconnect the steering knuckle flange arm from the tie rod end. Check and adjust the steering knuckle flange bearings (par. 213c(5)).

**b. Vehicle Wanders.**

(1) *Insufficient lubrication.* Lubricate steering system (par. 69).

(2) *Steering gear incorrectly adjusted.* Refer to *a*(3) above.

(3) Unequal tire pressure. Inflate tires to correct pressure (par. 248b).

(4) *Tie rod ends worn.* Check tie rod ends for looseness and replace if necessary (par. 226).

(5) *Incorrect toe-in adjustment.* Adjust toe-in (par. 224).

(6) *Spring weak or broken.* Inspect the springs for weak or broken leaves and replace if necessary (par. 245 or 246).

(7) *Steering gear mounting bolts loose.* Check and tighten steering gear mounting bolts if necessary.

*c. Front End Shimmy.*

(1) *Unequal tire pressure.* Inflate tires to correct pressure (par. 248b).

(2) *Steering gear mounting bolts loose.* Refer to b(7) above.

(3) *Front hub bearings worn or incorrectly adjusted.* Adjust bearings or replace if necessary (par. 208).

(4) *Wheel damaged.* Refer to paragraph 100.

(5) *Tie rod ends worn.* Refer to b(4) above.

(6) *Loose or worn steering knuckle flange bearings.* Replace if necessary (par. 213).

### 103. Windshield Wipers

*a. Both Windshield Wipers Inoperative.*

(1) *Restricted vacuum pump-to-tee line or air regulating valve-to-distributor tee line hose.* Inspect the vacuum line for dents or damage. Inspect the hose for cracks or signs of deterioration. Replace if necessary (par. 259e).

(2) *Loose connections.* Make certain all line and hose connections are tight.

(3) *Vacuum pump inoperative.* Replace fuel and vacuum pump with one known to be operating (par. 137).

(4) *Windshield wiper motor inoperative.* Replace wiper motor with one known to be operating (par. 259c).

*b. Right Windshield Wiper Inoperative.*

(1) *Center windshield wiper line loose or damaged.* Tighten connections or replace the line (par. 259d(2)).

(2) *Windshiled wiper motor inoperative.* Replace wiper motor with one known to be operating (par. 259c).

## Section V. ENGINE DESCRIPTION AND MAINTENANCE IN VEHICLE

### 104. Description and Data

(fig. 36)

*a. Description.*

(1) *Engine.* The engine is a four-cylinder, liquid-cooled, gasoline engine of the F-head design with a combination valve-in-head and valve-in-block construction. The engine can operate when totally submerged in water, provided it is equipped with a deep-water fording ventilation system. Parts for the fording system can be requisitioned as a kit. The intake valves are located in the cylinder head while the exhaust valves are located in the cylinder block. Intake

valves are operated through intake valve push rods and by overhead valve rocker arms. The exhaust valves, which are equipped with rotator caps, are operated by valve tappets in the cylinder block. The intake manifold is of the sealed in type, cast directly into, and considered a part of the cylinder head. The exhaust manifold assembly, a single case unit, is attached to the left side of the cylinder block. The power plant, including the engine, transmission, transfer, and radiator, is designed to be removed from the vehicle as a complete unit. The removal and installation of the power plant is described in paragraphs 120 and 124 for the M38A1, and paragraphs 121 and 125 for the M170.

- (2) *Engine lubrication.* The engine is lubricated by a force feed, continuous circulating system. A planetary gear-type oil pump, driven by the camshaft, delivers oil under pressure to drilled oil passages and external oil pipes and lines which, in turn, direct oil to all moving parts of the engine. Oil is drawn through a floating-type oil strainer in the oil pan. The replaceable element-type oil filter is mounted on the right side of the engine. A portion of the engine oil is continuously passed through the filter where foreign materials are removed before the oil is returned to the oil pan.
- (3) *Engine nomenclature.* The fan end of the engine will be referred to as the "front." The flywheel end of the engine will be referred to as the "rear." The terms "left" and "right"

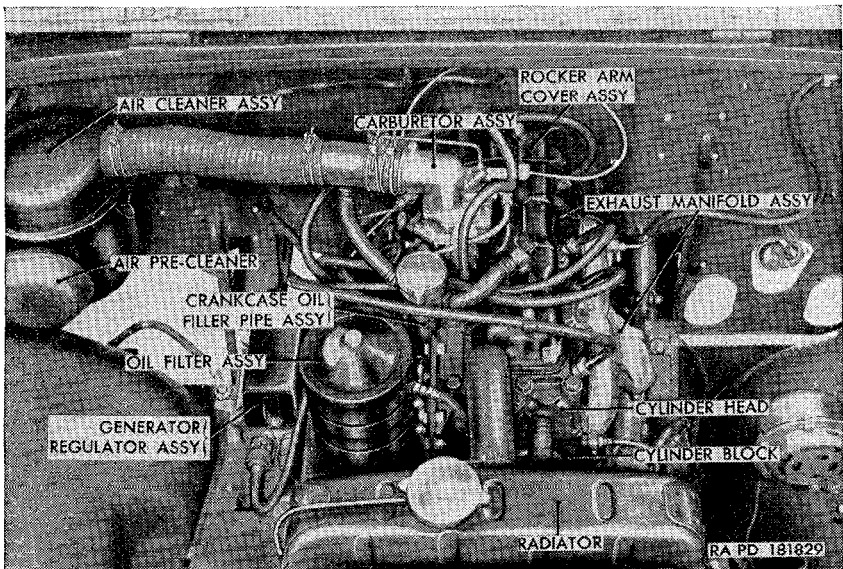

Figure 36. Engine installed in vehicle (M38A1).

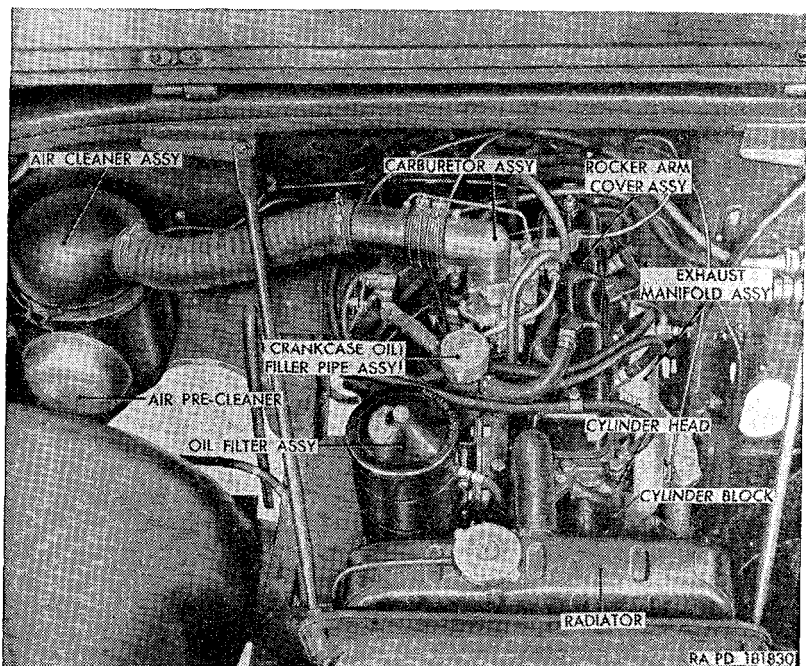

Figure 37. Engine installed in vehicle (M170).

are used with reference to the engine as viewed from the rear. Cylinders are numbered from the front. The crankshaft rotates in a clockwise direction when viewing the engine from the front.

*b. Data.*

Type.....	F head
Make.....	Willys
Number of cylinders.....	4
Bore.....	3 $\frac{1}{8}$ in.
Stroke.....	4 $\frac{3}{8}$ in.
Compression ratio.....	7.4 to 1
Compression pressure.....	135 psi at 185 rpm
Displacement.....	134.2 cu-in.
Maximum brake horsepower.....	72 at 4,000 rpm
Maximum torque.....	114 foot-pounds at 2,000 rpm
Firing order.....	1-3-4-2
Valve clearance:	
Intake.....	0.018 in.
Exhaust.....	0.016 in.
Weights:	
Power plant.....	680.81 lb
Engine, dry weight complete with flywheel and accessories.....	499.65 lb
Engine, dry weight complete with flywheel, less accessories.....	365.15 lb
Oil capacities:	
With oil filter.....	5 qt
Without oil filter.....	4 qt

## 105. Operations Performed With Engine in Vehicle

Most of the organizational maintenance operations on the engine and engine accessories can be performed with the engine installed in the vehicle. These maintenance operations, with a reference to the specific paragraph for detailed instructions, are listed below:

	<i>Paragraph</i>
Air cleaner assembly.....	136
Batteries and cables.....	162
Carburetor assembly.....	134
Carburetor controls (accelerator, throttle, and choke).....	135
Cooling system.....	126-132
Cylinder compression test.....	106
Cylinder head gasket.....	111
Exhaust manifold.....	112
Exhaust manifold gaskets.....	113
External lines and fittings.....	118
Fan and generator drive belts.....	130
Fuel and vacuum pump assembly.....	137
Generator assembly.....	158
Generator regulator assembly.....	159, 160
Ignition system.....	147-153
Manifold vacuum test.....	107
Oil filler pipe assembly.....	117
Oil filter assembly.....	115
Oil filter element.....	114
Rocker arm cover assembly and gasket.....	108
Starter and starter switch assemblies.....	155, 156
Valve clearance adjustment.....	110
Valve compartment cover and gasket.....	109

## 106. Cylinder Compression Test

*a.* Start engine (par. 42) and run until normal operating temperature (160° to 180° F.), is reached. Stop the engine and tighten the cylinder head screws to a torque of 60-65 foot-pounds in the sequence shown in figure 48.

*b.* Remove spark plugs (par. 153*c*).

*c.* Pull the throttle control out to wide open position. Make sure the choke control is pushed in all the way against the instrument panel.

*d.* Shut off the fuel flow by turning the fuel shutoff valve (Q, fig. 55) off.

*e.* Insert a conventional-type compression gage (fig. 38) into the spark plug holes, one at a time, beginning with the number one cylinder, and crank the engine with the starter. Record the highest compression reading from each cylinder on DA Form 461.

*f.* Compare the compression pressures of the cylinders. Normal compression pressure is 125 psi at a starter speed of 185 rpm. The minimum compression allowable is 100 psi. Readings of cylinder pressure should not vary more than 10 psi. A low compression reading on two adjacent cylinders indicates the possibility of a leak from

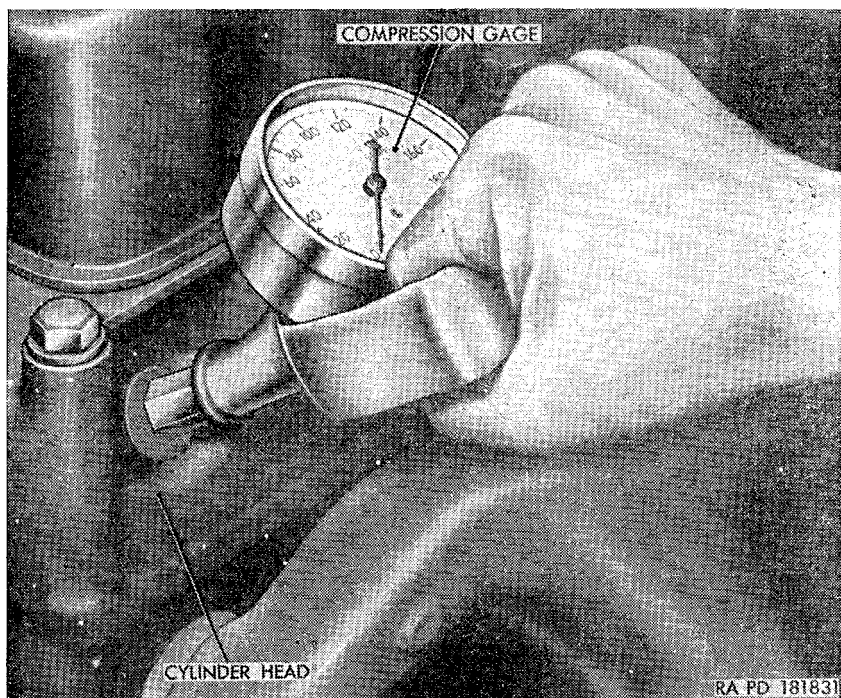

Figure 38. Checking cylinder compression.

one cylinder to the other at the cylinder head gasket. The leakage may be caused by improperly tightened cylinder head screws or a faulty cylinder head gasket. Tighten the cylinder head screws to a torque of 60–65 foot-pounds in the sequence shown in figure 48. Check cylinder compression again. If compression is still low on adjacent cylinders, there may be leakage because of a faulty cylinder head gasket. Before replacing the gasket (par. 111), check the manifold vacuum (par. 107) to see if there is leakage at the gasket.

*g.* If compression readings are uniformly low, the low compression may be due either to leakage at the valves or piston rings, or incorrect valve timing. Perform the manifold vacuum test (par. 107) to determine the cause of low compression.

*h.* If compression pressures of cylinders vary more than 10 psi, or are lower than 100 psi (after corrections indicated by the vacuum test have been made), notify ordnance maintenance personnel.

*i.* After completing the compression test, turn the fuel shutoff valve on and install the spark plugs (par. 153*d*).

### 107. Manifold Vacuum Test

*a.* Raise the hood (par. 255*a*). Remove the pipe plug installed in the top of the cylinder head, below and to the front of the carburetor assembly. Using suitable connectors and adapters, connect the hose

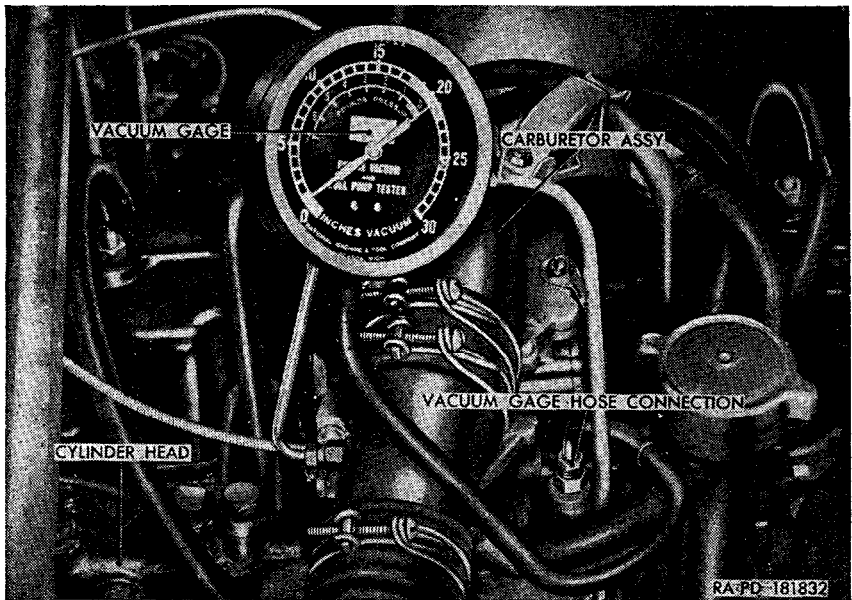

Figure 39. Checking manifold vacuum.

of a conventional vacuum gage to the opening in the cylinder head (fig. 39). Be sure all connections are tight, as even a slight leak will result in a false reading.

b. Start engine (par. 42) and run at idling speed until minimum operating temperature (160° F.) is reached. Check carburetor adjustments (par. 134a).

c. With the engine running at normal idling speed, vacuum gage should show a steady reading of from 17 to 21 inches of mercury. As a further check, open and close the throttle quickly. If the engine is in good condition, vacuum should drop to 2 inches at wide open throttle and quickly return to approximately 25 inches at closed throttle. If this action is not obtained, worn piston rings, or an abnormal restriction in the carburetor, air cleaner, or exhaust system are indicated.

d. Incorrect valve timing is indicated by a steady reading of approximately 10 inches of mercury.

e. Weak valve springs are indicated by a rapid fluctuation of the gage hand when the engine is accelerated. If a valve sticks at times only, the vacuum drops 4 or 5 inches momentarily when the valve sticks, and fluctuation resumes when the valve is operating properly again. A rapid fluctuation of the gage hand between 14 and 19 inches indicates that the valve guides are worn.

f. A slow movement of the gage hand between 12 and 16 inches indicates poor carburetion.

*g.* Leakage at the carburetor gasket is indicated by a steady reading of 3 to 4 inches. Leakage of compression between the cylinders is indicated by the gage hand drifting regularly between 5 and 19 inches. Worn or poorly fitted piston rings or scored pistons and cylinder walls are indicated by the gage hand remaining lower than normal, at approximately 15 inches.

*Note.* The above readings are for sea level operation. At higher elevations, the vacuum gage readings are lowered approximately 1 inch of mercury for each 1,000 feet increase in altitude.

*h.* After performing the manifold vacuum tests, disconnect the vacuum gage hose from the connectors and adapters in the cylinder head. Remove the connectors and adapters from the cylinder head and install the  $\frac{1}{4}$ -inch pipe plug. Tighten the plug.

*i.* Close the hood (par. 255*b*).

## 108. Rocker Arm Cover Assembly and Gasket

### *a. Removal.*

- (1) Disconnect the spark plug cables from plugs and free the cables from the clips (fig. 40) that retain them.
- (2) Loosen the screw (N, fig. 64) in the throttle control wire stop with screw assembly (M, fig. 64) and pull the stop off the end of the throttle control wire (S, fig. 64). Remove the two lockwasher screws securing the throttle control conduit clamp (V, fig. 65) to the top of the carburetor. Swing the control wire and clamp out of the way of the rocker arm cover assembly.
- (3) Remove the cotter pins and flat washers securing the throttle rod (B, fig. 65) to the accelerator upper bellcrank assembly

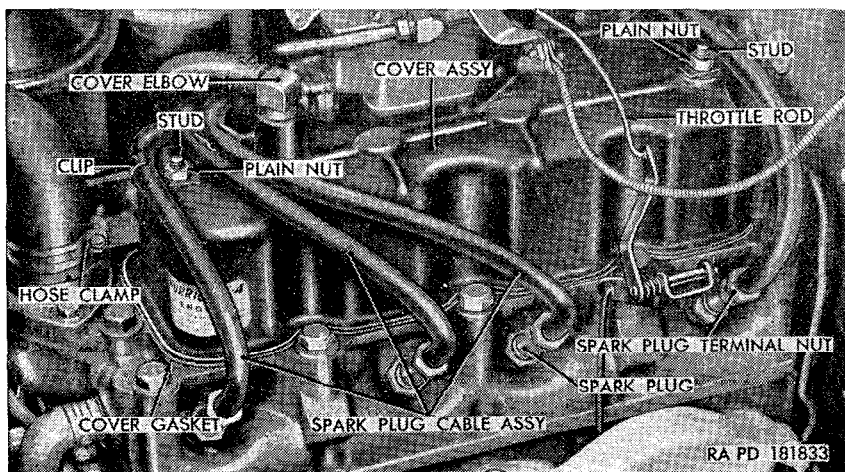

Figure 40. Rocker arm cover assembly installed.



(D, fig. 65) and the carburetor throttle valve lever (U, fig. 65), and remove the rod.

- (4) Remove the hose clamp securing the oil filler tube-to-rocker arm cover hose to the rocker arm cover elbow. Pull the hose free of the elbow.
- (5) Remove the two plain nuts securing the rocker arm cover to the studs installed in the rocker arm shaft brackets mounted on the cylinder head. Lift the three clips off the front stud and one off the rear stud. Remove the gasket-type copper

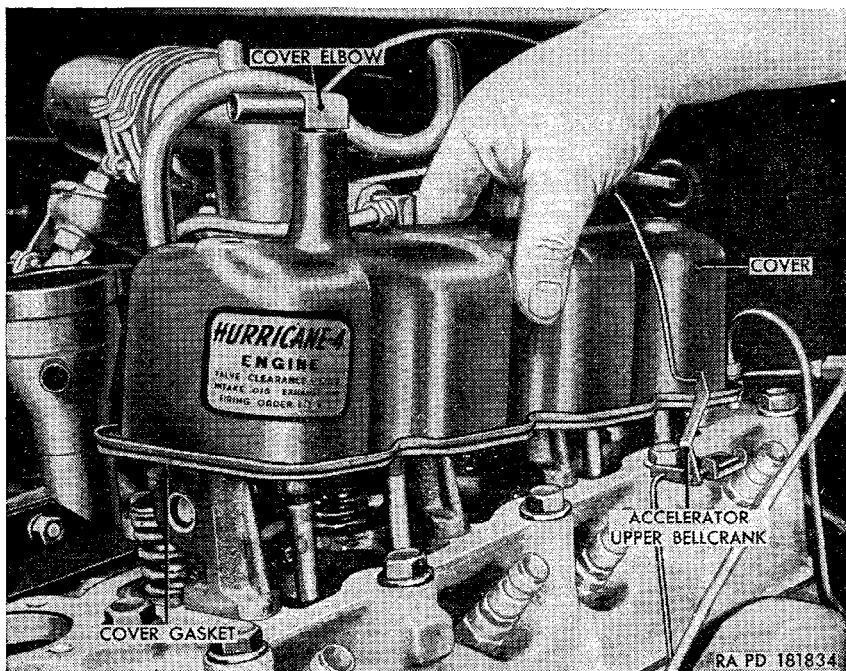

Figure 41. Removing rocker arm cover assembly.

washer from each stud. Lift the rocker arm cover (fig. 41) off the cylinder head. Remove and discard the rocker arm cover gasket.

- (6) Unscrew the rocker arm cover elbow from the top of the cover.
- (7) Do not remove the two studs (fig. 43) from the two end rocker arm shaft brackets unless they are damaged. To remove the studs, unscrew them from the tops of the brackets and remove the internal-teeth lock washer from each stud.

#### *b. Installation.*

- (1) If the studs (fig. 43) securing the rocker arm cover assembly were removed, install them. Using one  $\frac{5}{16}$ -inch internal-

teeth lock washer between each stud and rocker arm shaft bracket, install the  $\frac{5}{16}$ -inch studs so the short threaded ends enter the tapped holes in the brackets.

- (2) Screw the rocker arm cover elbow (fig. 40) into the opening provided at the top front of the rocker arm cover assembly. Position elbow so its opening faces approximately  $30^\circ$  to the right.
- (3) Coat a new rocker arm cover gasket with plastic-type gasket cement and position the gasket in place on the bottom of the rocker arm cover (fig. 41).
- (4) Position the rocker arm cover in place on top of the cylinder head. Install a  $\frac{5}{16}$ -inch gasket-type copper washer on each stud. Install three spark plug cable clips (fig. 40) with the longest first and following with the next longest and then the shortest in that order on the front stud. Install one short clip on the rear stud. Secure the cover by installing one  $\frac{5}{16}$ -inch plain nut on each stud.
- (5) Slip the free end of the oil filler tube-to-rocker arm cover hose over the end of the rocker arm cover elbow (fig. 41). Secure the hose to the elbow with the hose clamp.
- (6) Install the throttle rod (B, fig. 65) in the accelerator upper bellcrank assembly (D, fig. 65) and the carburetor throttle valve lever (U, fig. 65). Secure the rod to the bellcrank and the lever with No. 8 flat washer and  $\frac{1}{16} \times \frac{1}{2}$  cotter pins.
- (7) Position the throttle control conduit clamp (V, fig. 65) in place on top of the carburetor and secure the bracket to the carburetor with two No. 8  $\times \frac{5}{16}$  lockwasher screws. Insert the end of the throttle control wire (S, fig. 64) through the adjusting block mounted on the throttle rod. Slide the hand throttle control wire stop with screw (M, fig. 64) over the free end of the control wire (S, fig. 64). Lock the stop to the wire by tightening the setscrew (N, fig. 64) in the stop.
- (8) Connect the spark plug cables (fig. 40) to the spark plugs. Secure each cable in the clips installed on the studs that secure the rocker arm cover.
- (9) Adjust the hand throttle control wire stop (par. 135*h*(1)). Lower the hood (par. 255*b*).

## 109. Valve Compartment Cover and Gasket

(fig. 42)

### *a. Removal.*

- (1) Raise the hood (par. 255*a*).
- (2) Disconnect the accelerator pedal return spring (T, fig. 65) from the lower accelerator bellcrank and the pipe plug in the cylinder block. Remove the cotter pin and the flat washer

securing the accelerator bellcrank link rod to the bellcrank and free the rod from the bellcrank. Unscrew the compartment cover special stud, with the accelerator lower bellcrank attached, from the cover and the cylinder block. Remove the plain washer from the stud. Lower the stud and bellcrank as far as the link of the accelerator pedal assembly will allow.

- (3) Unscrew the special cap screw securing the crankcase vent body and valve compartment cover to the cylinder block. Remove the gasket-type washer from the outer side of the body. Remove the hose clamp securing the crankcase vent

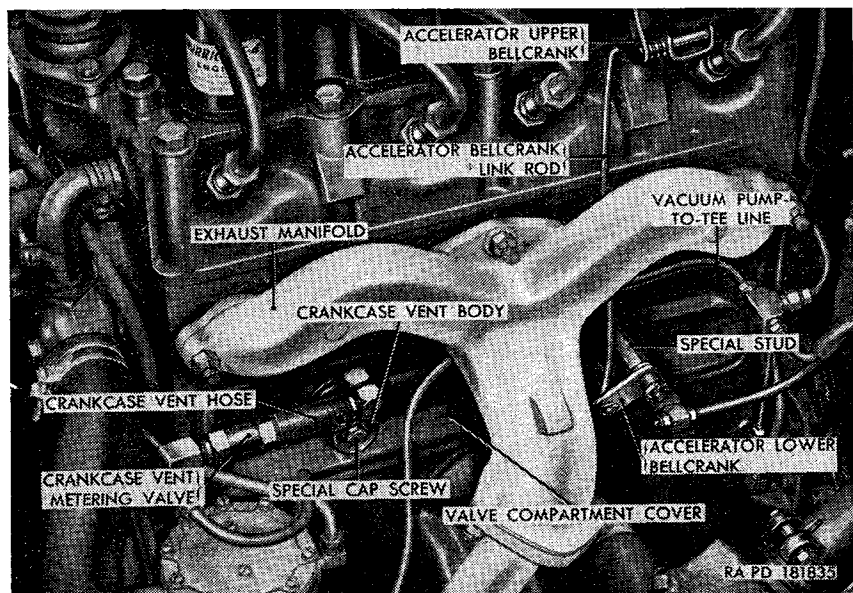

Figure 42. Valve compartment cover—installed.

hose to the crankcase vent metering valve. Pull the hose with the vent body from the metering valve. Remove and discard the crankcase vent body-to-valve cover gasket from the inner side of the vent body.

- (4) Move the valve compartment cover to the rear, as necessary, and then forward until it is on the outside of the vacuum pump-to-tee line. Maneuver the cover to the rear again until it is on the left of the brake pedal shank and pull the cover up and out of the engine compartment.
- (5) Remove the valve compartment cover gasket from either the cover or the cylinder block.

#### *b. Installation.*

- (1) Clean the valve compartment cover and the mating surfaces of the cylinder block of all gasket material. Coat a new valve

compartment cover gasket with plastic-type gasket cement and position it in place on the inner side of the valve compartment cover.

- (2) Maneuver the rear of the compartment cover to the left of the brake pedal shank; then move it forward and then rearward again to the right of the shank and then forward again to the right of the shank and then forward again, making sure it is on the inner side of the vacuum pump-to-tee line.
- (3) Coat a new crankcase vent body-to-valve cover gasket with plastic-type gasket cement. Position the gasket on the inner side of the vent body. Slip the hose that is attached to the crankcase vent body onto the crankcase vent metering valve and secure the hose to the valve by installing the hose clamp. Aline the valve compartment cover holes with the cylinder block holes. Place the vent body over the hole in the front of the compartment cover and install the  $\frac{5}{16}$ -inch gasket-type washer on the  $\frac{5}{16} \times 3\frac{1}{16}$  special cap screw, and install the cap screw through the vent body, compartment cover, and into the cylinder block. Tighten the screw.
- (4) Install the  $\frac{5}{16}$ -inch plain washer on the  $\frac{5}{16}$ -inch compartment cover special stud. Secure the rear of the compartment cover to the cylinder block by installing the stud with the accelerator bellcrank attached. Connect the lower end of the accelerator bellcrank link rod to the bellcrank and secure the rod to bellcrank with a  $\frac{1}{16} \times \frac{1}{2}$  cotter pin. Connect the accelerator pedal return spring (T, fig. 65) to the bell crank and to the pipe plug in the cylinder block.
- (5) Close the hood (par. 255b).

## 110. Valve Clearance Adjustment

*Note.* Adjust valves with engine cold.

### *a. Intake Valves.*

- (1) Remove the rocker arm cover assembly and gasket (par. 108a(1) through (5)).
- (2) Using a suitable socket wrench and extensions, turn the engine crankshaft, as necessary, to bring each intake valve in turn to the fully closed position. Check the valve clearance by inserting a feeler gage between the valve stem cap and the rocker arm (fig. 43). The valve clearance should be 0.018 inch.
- (3) Adjust the valve clearance by loosening the plain nut on the valve rocker arm adjusting screw and turning the adjusting screw (fig. 44) in or out, as necessary, to obtain the proper clearance between the end of the valve stem cap and the rocker arm. Turn the screw clockwise to close the gap and counter-

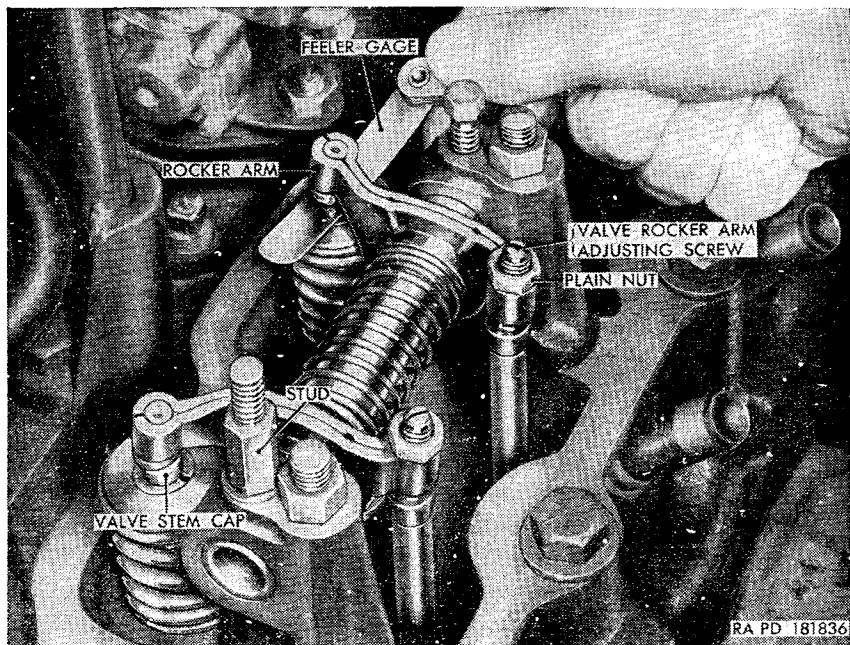

Figure 43. Checking intake valve clearance.

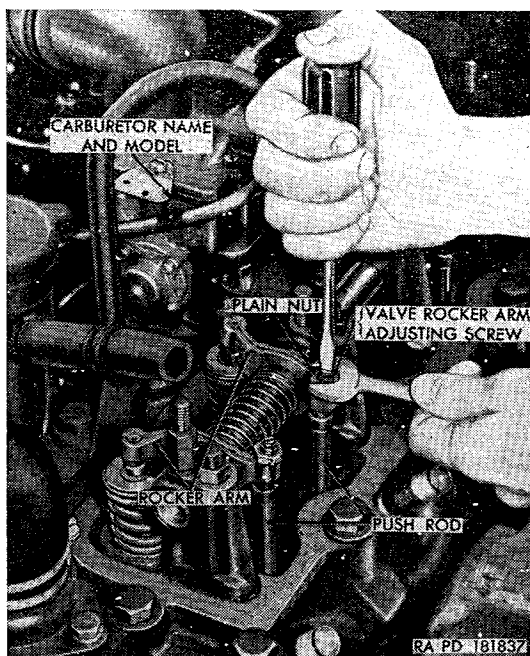

Figure 44. Adjusting intake valve clearance.

clockwise to open the gap. When the gap is adjusted so an 0.018-inch feeler gage can be inserted with only a slight drag, hold the screw in that position and tighten the plain nut to lock the screw in place. When all valves are adjusted, check clearance again to make certain the nut tightening did not disturb the adjustment.

- (4) Install the rocker arm cover assembly and rocker arm cover gasket (par. 108*b*(3) through (9)).

*b. Exhaust Valves.*

- (1) Remove the valve compartment cover and gasket (par. 109*a*).
- (2) Using a suitable socket wrench and extensions, turn the engine crankshaft, as necessary to bring each exhaust valve (fig. 45) in turn to full closed position (exhaust valve tappet all the way down).

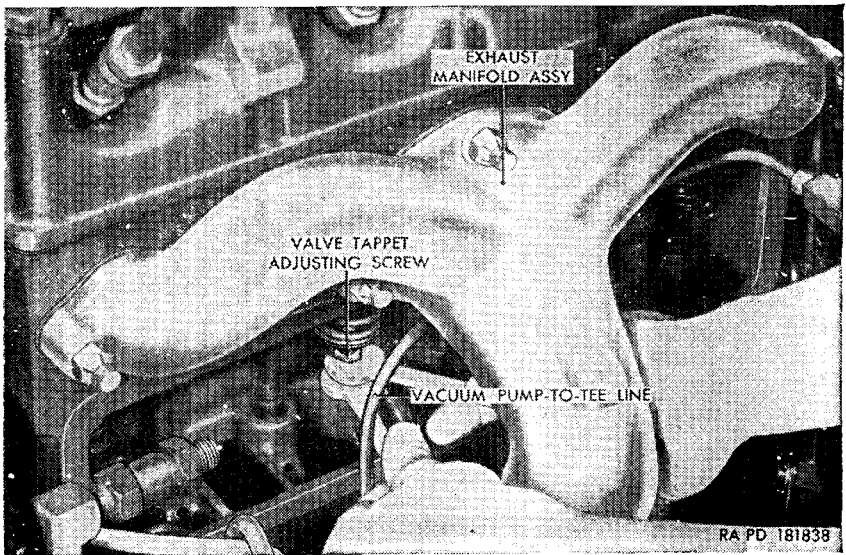

*Figure 45. Adjusting exhaust valve clearance.*

- (3) Check the exhaust valve clearance by inserting a feeler gage between the end of the valve tappet adjusting screw (fig. 45) and the bottom of the exhaust valve rotator cap and measure clearance. The clearance should be 0.016 inch.
- (4) Adjust the valve clearance by placing one wrench on the exhaust valve tappet and another wrench on the valve tappet adjusting screw, hold tappet from turning and turn the adjusting screw in or out, as necessary, to obtain the correct clearance.
- (5) Install the valve compartment cover and gasket (par. 109*b*).

## 111. Cylinder Head Gasket

*Note.* The key letters noted in parentheses refer to figure 46, except where otherwise indicated.

### *a. Removal.*

- (1) Raise the hood (par. 255a).
- (2) Drain the cooling system (par. 127a(1)).
- (3) Remove the rocker arm cover assembly and gasket (par. 108a(1) through (5)).
- (4) Loosen the hose clamp securing the lower end of the water pump bypass hose (J) to the water pump and pull the hose off the connection on top of the pump.

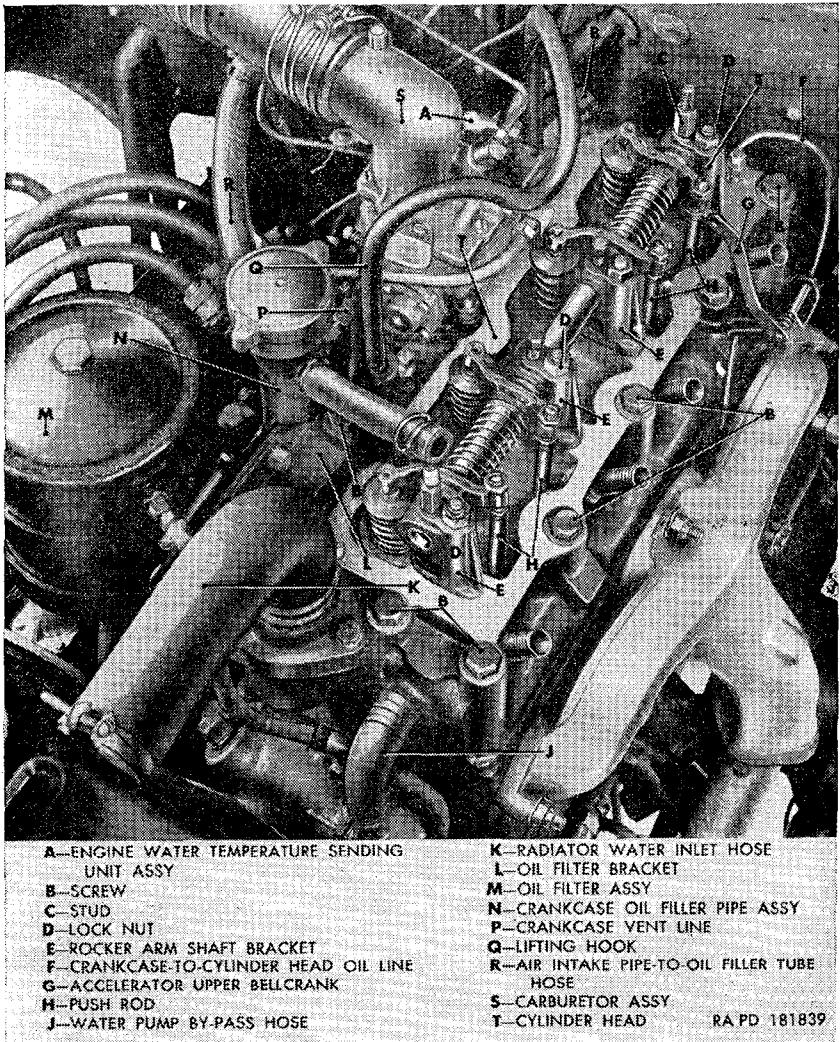

A—ENGINE WATER TEMPERATURE SENDING UNIT ASSY

B—SCREW

C—STUD

D—LOCK NUT

E—ROCKER ARM SHAFT BRACKET

F—CRANKCASE-TO-CYLINDER HEAD OIL LINE

G—ACCELERATOR UPPER BELLCRANK

H—PUSH ROD

J—WATER PUMP BY-PASS HOSE

K—RADIATOR WATER INLET HOSE

L—OIL FILTER BRACKET

M—OIL FILTER ASSY

N—CRANKCASE OIL FILLER PIPE ASSY

P—CRANKCASE VENT LINE

Q—LIFTING HOOK

R—AIR INTAKE PIPE-TO-OIL FILLER TUBE

HOSE

S—CARBURETOR ASSY

T—CYLINDER HEAD

RA PD 181839

Figure 46. Cylinder head—installed rocker arm cover removed.

- (5) Loosen the hose clamp securing the radiator water inlet hose (K) to the radiator. Pull the hose off the radiator neck.
- (6) Unscrew the fitting on the crankcase-to-cylinder head oil line (F) from the connector installed at the rear of the cylinder head on the left side.
- (7) Disconnect cable No. 33 from the engine water temperature sending unit assembly (A) installed on the right side of the cylinder head.
- (8) Unscrew the crankcase vent line (P) from the tee installed on the right side of the cylinder head.
- (9) Remove the hose clamp securing the air intake pipe-to-oil filler tube hose (R) to the carburetor air intake pipe and pull the hose free of the tube projection on the intake pipe.
- (10) Remove the lockwasher bolt securing the oil filler pipe support bracket (fig. 51) to the right side of the cylinder head.

*Note.* The bracket secures the crankcase oil filler pipe assembly (N).

- (11) Remove the carburetor assembly (S) (par. 134b).
- (12) Unscrew the studs (C) from the tops of the two end rocker arm shaft brackets (E). Turn the studs over and screw the long ends of the studs into the brackets so that the rocker arm assembly components will stay together as a unit when removed from the cylinder head.
- (13) Remove the four lock nuts (D) securing the rocker arm shaft brackets (E) to the studs in the top of the cylinder head. Lift the rocker arm shaft brackets, rocker arms, rocker arm shaft, and springs as a unit from the top of the cylinder head.
- (14) Remove the four push rods (H) by lifting them out through the cylinder head holes.
- (15) Remove the two screws securing the lifting hook (Q) to the cylinder head and the cylinder head to the cylinder block. Remove the lifting hook. Remove the flat washer beneath the lifting hook and the top of the cylinder head at the rear hole of the hook.
- (16) Remove the screw securing the oil filter bracket (L) to the cylinder head and the right front of the cylinder head to the cylinder block. Push the bracket and oil filter assembly (M) away from cylinder head to prevent interference with the head when removing it.
- (17) Remove the screw securing the accelerator upper bellcrank (G) to the cylinder head and the left side of the cylinder head to the cylinder block.



- (18) Working through the hole over which the carburetor is mounted, when installed, remove the screw securing the cylinder head to the cylinder block.
- (19) Remove the remaining 10 screws (B) and flat washers securing the cylinder head to the cylinder block.
- (20) Lift the cylinder head (T) from the top of the cylinder block.
- (21) Remove and discard the cylinder head gasket (fig. 47) from either the bottom of the cylinder head or the top of the cylinder block.

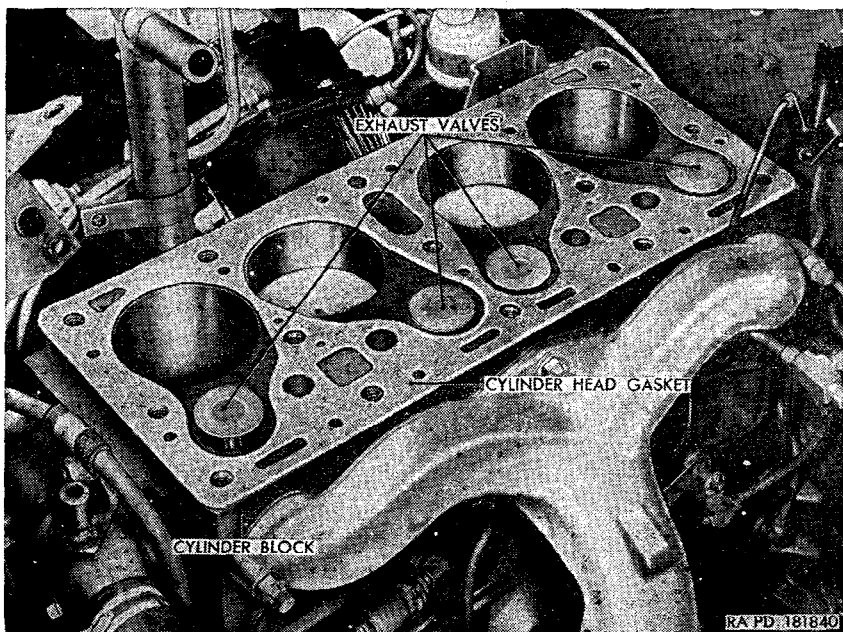

Figure 47. Cylinder head gasket positioned on cylinder block.

#### *b. Installation.*

- (1) Clean gasket and carbon deposits from both the cylinder head and the cylinder block.
- (2) Carefully position a new cylinder head gasket on the cylinder block (fig. 47).
- (3) Carefully lower the cylinder head onto the cylinder head gasket and cylinder block. Insert a  $\frac{7}{16}$ -inch flat washer and  $\frac{7}{16} \times 4\frac{1}{4}$  screw at each end of the cylinder head to properly align cylinder head with cylinder head gasket and cylinder block.
- (4) Position the oil filter bracket (L) on the cylinder head in alignment with the first two holes on the right side, and install the  $\frac{7}{16} \times 4\frac{1}{4}$  screw in the front hole.

- (5) Position the lifting hook (Q) over the rear hole in the oil filter bracket and start a  $\frac{7}{16} \times 4\frac{5}{8}$  screw into the thread.

*Note.* The loop of the hook must face the center of the engine.

Do not tighten screw. Position a  $\frac{7}{16}$ -inch flat washer between the bottom of the hook and the top of the cylinder head at the rear of the hook. Install a  $\frac{7}{16} \times 4\frac{5}{8}$  screw through the hook, washer, and cylinder head. Tighten the two screws.

- (6) Position the accelerator upper bellcrank (G) on the left side of the cylinder head over the fourth hole (counting from the front). Install the  $\frac{7}{16} \times 4\frac{1}{4}$  screw through the bellcrank and cylinder head.
- (7) Working through the hole over which the carburetor is mounted, when installed, install the  $\frac{7}{16} \times 1\frac{11}{16}$  screw.

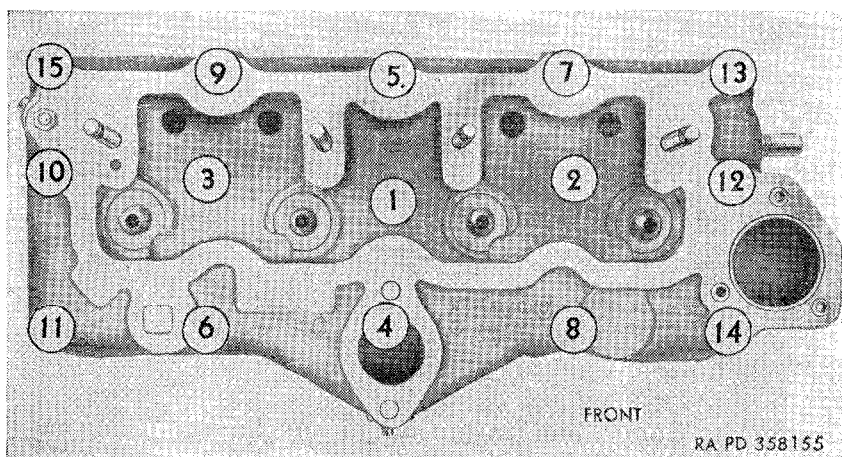

*Figure 48. Cylinder head screw tightening sequence.*

- (8) Install the remaining eight  $\frac{7}{16}$ -inch flat washers and  $\frac{7}{16} \times 4\frac{1}{4}$  screws (B).
- (9) Tighten all the screws to a torque of 60–65 foot-pounds in the sequence shown in figure 48.
- (10) Install the four push rods (H) by inserting them through the holes in the left side of the cylinder head.
- (11) Aline the holes in the rocker arm shaft brackets (E) with the studs mounted in the cylinder head and position the brackets, rocker arms, rocker arm shaft, and springs as a unit on top of the cylinder head. Make certain push rods are properly positioned in rocker arm sockets. Secure the brackets to the studs by installing the four  $\frac{3}{8}$ -inch lock nuts (D) on the studs. Tighten nuts to a torque of 30–36 foot-pounds.

(12) Unscrew the studs (C) from the tops of the rocker arm shaft brackets (E) at the front and rear of the shaft assembly. Turn the studs over and screw the short ends of the studs into the brackets.

(13) Install the carburetor assembly (S) (par. 134c).

(14) Secure the oil filler pipe support bracket to the right side of the cylinder head with a  $\frac{5}{16} \times 1\frac{1}{4}$  lockwasher bolt.

*Note.* The bracket secures the crankcase oil filler pipe assembly (N).

(15) Install the free end of the air intake pipe-to-oil filler tube hose (R) on the tube projection provided on the carburetor air intake pipe. Secure the hose to the tube projection by installing the hose clamp.

(16) Connect the crankcase vent line (P) to the tee installed on the right side of the cylinder head.

(17) Connect cable No. 33 to the engine water temperature sending unit assembly (A) installed on the right side of the cylinder head.

(18) Connect the crankcase-to-cylinder head oil line (F) to the connector installed at the rear of the cylinder head on the left side by screwing the fitting on the line into the connector.

(19) Slide the radiator water inlet hose (K) on the radiator neck and secure hose to neck by installing the radiator hose clamp.

(20) Slide the lower end of the water pump bypass hose (J) on the connection on top of the water pump. Secure the hose to the connection by tightening the hose clamp.

(21) Check the intake valve clearance (par. 110a).

(22) Install the rocker arm cover assembly and rocker arm cover gasket (par. 108b(3) through (9)).

(23) Fill the cooling system (par. 127a(2)).

(24) Close the hood (par. 255b).

## 112. Exhaust Manifold Assembly

### a. Removal.

(1) Raise the hood (par. 255a).

(2) Disconnect the exhaust pipe from the exhaust manifold assembly (par. 146a(1)).

(3) Remove the five self-locking nuts securing the exhaust manifold assembly (fig. 42) to the studs mounted in the cylinder block. Remove the plain washer from the top center stud. Pull the clip securing the vacuum pump-to-tee line from the right lower stud.

(4) Pull the exhaust manifold away from the engine until it clears the studs in the cylinder block and then up to disengage the exhaust pipe from the stud in the manifold.

- (5) If the studs in the cylinder block are damaged, remove them.
- b. Installation.*
- (1) If any studs were removed from the side of the cylinder block, install them. Use  $\frac{3}{8}$ -16NC-2 x  $\frac{3}{8}$ -24NF-3 x  $1\frac{1}{8}$  studs in the lower center holes and the two end holes, and a  $\frac{3}{8}$ -16NC( $\frac{1}{2}$ ) x  $\frac{3}{8}$  x  $\frac{3}{8}$ -24NF( $\frac{7}{8}$ ) x  $1\frac{3}{4}$  stud in the top center hole on the side of the cylinder block.
  - (2) Aline the holes in the exhaust manifold assembly (fig. 42) with the studs in the cylinder block and position the exhaust manifold on the studs. Place a  $1\frac{1}{2}$ -inch plain washer on the top center stud. Place the clip securing the vacuum pump-to-tee line on the right lower stud. Secure the manifold to the studs with five  $\frac{3}{8}$ -inch self-locking nuts. Tighten nuts to a torque of 29–35 foot-pounds.
  - (3) Connect the exhaust pipe to the exhaust manifold assembly (par. 146*b* (1), (3), and (5)).
  - (4) Close the hood (par. 255*b*).

### 113. Exhaust Manifold Gaskets

*a. Removal.*

- (1) Remove the exhaust manifold assembly (par. 112*a*).
- (2) Remove and discard the exhaust manifold center gasket and the two exhaust manifold end gaskets from the studs in the cylinder block.

*b. Installation.*

- (1) Aline the holes in the new exhaust manifold center gasket with the three center studs in the side of the cylinder block and position the gasket on the studs. Aline the hole in each of the two new exhaust manifold end gaskets with an end stud and position the gaskets on the studs, making certain that the metal portions of the gaskets are inserted into the exhaust ports.
- (2) Install the exhaust manifold assembly (par. 112*b*).

### 114. Oil Filter Element

*Note.* Servicing of the oil filter element consists of replacing the element at scheduled lubrication periods (par. 69).

*a. Removal.*

- (1) Raise the hood (par. 255*a*). Place a suitable container under the oil filter assembly, remove the drain plug (fig. 49), and allow oil to drain. Install drain plug after oil has drained.
- (2) Unscrew cover bolt and lift the oil filter cover off the oil filter case. Remove and discard the cover seal from the inside of the cover. The cover spring, located on the inside of the cover, seats on the bolt. It is not necessary to pull the spring off the bolt.

- (3) Wipe the top surface of the oil filter element (fig. 50) clean, grasp handle on element, and lift element out of the oil filter case. Clean inside of case with dry-cleaning solvent or volatile mineral spirits.

*b. Installation.*

- (1) Align the hole in the new oil filter element (fig. 50) with the mounting stud in the oil filter case and slide the element down on the stud, making certain the element seats properly in the case.

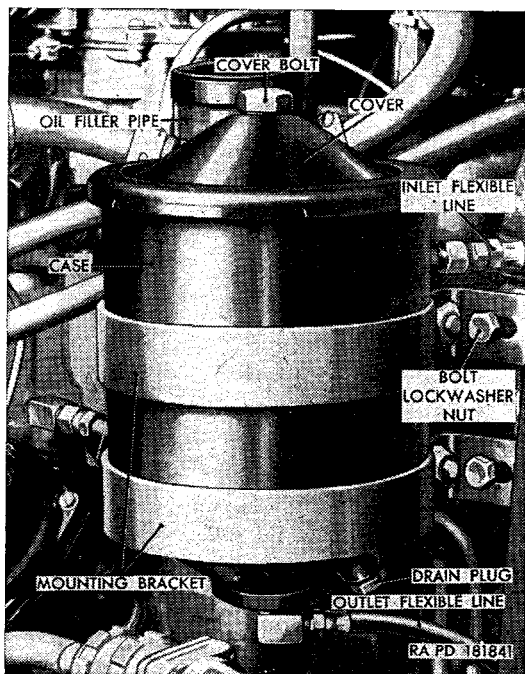

*Figure 49. Oil filter assembly installed.*

- (2) Install a new cover seal in the inside of the oil filter cover. Position the cover on top of the case, and secure the cover to the case by tightening the cover bolt (fig. 49).
- (3) Start and run engine to check for leaks at cover. Tighten cover bolt if necessary. Add oil to the engine lubricating system to bring the oil to the proper level (par. 69).
- (4) Close the hood (par. 252b).

## **115. Oil Filter Assembly**

*a. Removal.*

- (1) Drain the oil filter assembly (par. 114a(1)).
- (2) Unscrew the oil filter inlet flexible line (fig. 49) from the connector installed in the oil filter case.

- (3) Unscrew the oil filter outlet flexible line assembly from the connector installed in the timing gear cover (fig. 91).
- (4) Remove the two bolts and lockwasher nuts securing the upper of the two oil filter mounting brackets (fig. 49) to the mounting bracket mounted on the cylinder head. Remove the bolt and lockwasher nut securing the right side of the lower of the two mounting brackets to the bracket on the cylinder head. Remove the lockwasher nut securing the left side of the lower bracket of the two mounting brackets to the

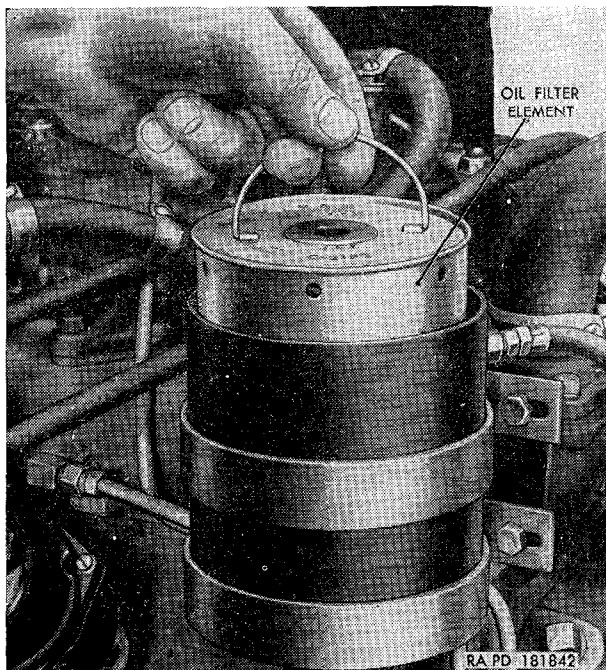

Figure 50. Removing oil filter element.

bolt mounted in the bracket on the cylinder head. Remove the oil filter assembly.

- (5) Unscrew the outlet flexible line from the elbow in the bottom of the oil filter case.
- (6) Unscrew the elbow from the bottom of the case. Unscrew the connector from the side of the case.

*b. Installation.*

- (1) Coat the threads of the connector and elbow with plastic type gasket cement. Screw the connector and elbow in place in the oil filter case. Connect the oil filter outlet flexible line assembly to the elbow.
- (2) Position the oil filter assembly on the mounting bracket on the right side of the cylinder head. Secure the upper of

the two oil filter mounting brackets to the bracket on the cylinder head with two  $\frac{5}{16} \times \frac{3}{4}$  bolts and  $\frac{5}{16}$ -inch lockwasher nuts. Secure the lower of the two brackets to the bracket on the cylinder head with one  $\frac{5}{16} \times \frac{3}{4}$  bolt and  $\frac{5}{16}$ -inch nut, and one  $\frac{5}{16}$ -inch lockwasher nut.

- (3) Connect the oil filter inlet flexible line assembly to the connector installed in the oil filter case.
- (4) Connect the free end of the oil filter outlet flexible line to the connector installed in the timing gear cover (fig. 91).
- (5) Start and run engine to check for leaks of connections. Tighten connections, if necessary. Add oil to engine lubricating system to bring oil up to the proper oil level (par. 69).
- (6) Close the hood (par. 255b).

## 116. Oil Filter Lines

### *a. Removal.*

- (1) Drain the oil filter assembly (par. 114a(1)).
- (2) Disconnect the oil filter inlet flexible line assembly at the oil filter case (par. 115a(2)).
- (3) Remove the bolt and lockwasher securing the clip on the oil filter flexible inlet line (fig. 60) to the water pump, and the water pump assembly to the block. Remove the bolt and lockwasher nut, securing the clip on the inlet line, and the timing gear cover, to the engine front mounting plate.
- (4) Remove the fuel and vacuum pump assembly (par. 137a).
- (5) Unscrew the inlet line from the elbow installed in the side of the cylinder block. Remove the inlet line and slide the two clips and looms off the line.
- (6) Disconnect the lower end of the oil filter outlet flexible line assembly (par. 115a(3)). Unscrew and remove the outlet line from the connector in the oil filter case (fig. 49).

### *b. Installation.*

- (1) Slide two looms and clips on the oil filter inlet flexible line assembly. Screw the lower end of the inlet line to the elbow in the side of the cylinder block.
- (2) Position one clip over one loom and secure the clip to the timing gear cover and the engine front mounting plate with a  $\frac{3}{8} \times \frac{3}{4}$  bolt and  $\frac{3}{8}$ -inch lockwasher nut.
- (3) Position the other clip over the other loom and secure the clip to the water pump assembly, and the water pump assembly to the cylinder block with a  $\frac{5}{16}$ -inch lockwasher nut and  $\frac{5}{16} \times \frac{7}{8}$  bolt.
- (4) Connect the inlet flexible line (fig. 49) to the oil filter case (par. 115b(3)).

- (5) Connect the oil filter outlet flexible line assembly to the connector in the oil filter case. Connect the lower end of the outlet line to the connector in the timing gear cover.
- (6) Install the fuel and vacuum pump assembly (par. 137*b*).
- (7) Check installation (par. 115*b*(5)).
- (8) Close the hood (par. 255*b*).

## 117. Crankcase Oil Filler Pipe Assembly

(fig. 51)

*a. Service.* The crankcase oil filler pipe assembly is a steel tube projecting from the cylinder block upper portion on the engine right

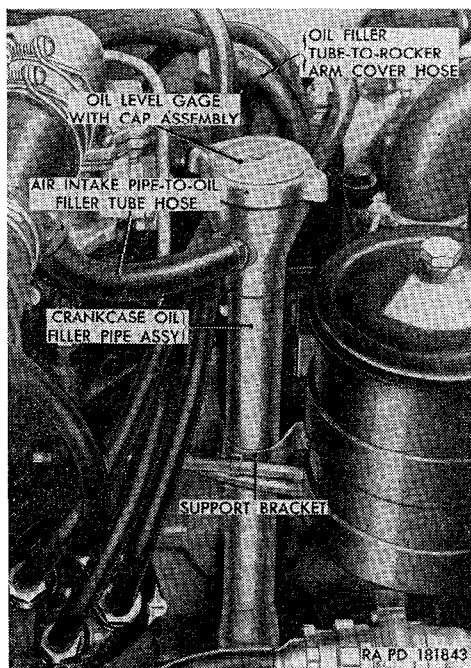

Figure 51. Crankcase oil filler pipe assembly—installed.

side. The pipe is equipped with an oil level gage with cap assembly. The bayonet-type gage is fastened to the underside of the cap. The cap and gage are removed to add engine oil. The gage is used to check the engine oil level.

*b. Removal.*

- (1) Raise the hood (par. 255*a*). Remove the oil level gage with cap assembly.
- (2) Remove the hose clamp securing the air intake pipe-to-oil filler tube hose to the filler pipe and pull the hose free of



the tube projection on the pipe. Remove the hose clamp securing the oil filler tube-to-rocker arm cover hose to the oil filler pipe and pull the hose free of the tube projection on the pipe.

- (3) Remove the lockwasher bolt securing the oil filler pipe support bracket to the cylinder head and remove the oil filler pipe.

*Note.* The filler pipe is a drive fit in the cylinder block. Some difficulty may be experienced in removal. The pipe may be loosened by tapping front and rear side alternately and, at the same time, pulling straight up on the pipe.

*c. Installation.* Do not install a used or damaged filler pipe, as a tight fit in the cylinder block is essential to prevent oil leakage.

- (1) Place a coating of plastic-type gasket cement around the circumference of the pipe at the area which will mate with the block. Insert the pipe end in the block opening, with the flat side, at center portion of pipe, facing the generator assembly. Tap pipe into place, using a soft mallet or wooden block.
- (2) Slip the ends of the air intake pipe-to-oil filler tube and the oil filler tube-to-rocker arm cover hoses on the tube projections of the filler pipe. Secure the hoses to the projections with the hose clamps.
- (3) Install the  $\frac{5}{16} \times 1\frac{1}{4}$  lockwasher bolt securing the oil filler pipe support bracket to the cylinder head. Install the oil level gage with cap assembly on the filler pipe.
- (4) Run engine until normal operating temperature (160°–180° F.) is reached and check filler pipe at lower end for leaks. Close the hood (par. 255b).

## **118. External Lines and Fittings**

*a.* External lines consist of flexible- and solid-type.

*b.* Fittings, as termed, consist of elbows, nipples, tees, and shutoff valve.

*c.* The lines and fittings for various systems are covered below.

- (1) Brake system (par. 236).
- (2) Oil filter assembly (par. 116).
- (3) Fuel lines and fittings (par. 142).
- (4) Windshield wiper lines and hoses (par. 259d).
- (5) Vent lines are in the paragraphs pertinent to major unit.

## Section VI. ENGINE REMOVAL AND REPLACEMENT

### 119. Coordination With Ordnance Maintenance Unit

For coordination with an ordnance maintenance unit, refer to paragraph 2.

### 120. Power Plant Removal (M38A1)

*a. Preliminary Operations.* The power plant (figs. 52 and 53), which consists of the engine, clutch, transmission, transfer, and radiator, must be removed from the vehicle as a unit before removing any of the individual components. It is not necessary to drain the radiator, crankcase, transmission, or transfer before removing the power plant.

- (1) Remove the hood (par. 255*c*).
- (2) Disconnect the battery ground cable (par. 162*b*(8)(*a*) and (*b*)).
- (3) Remove the radiator guard (par. 257*a*).

*b. Right Side Disconnections.*

*Note.* The key letters noted in parentheses refer to figure 54, except where otherwise indicated.

- (1) Loosen the two hose clamps (B) and remove the air cleaner-to-air intake pipe flexible hose (C).
- (2) Unscrew the connector (Y) from the generator receptacle (Z). Unscrew the connector (K) from the receptacle of the generator regulator assembly (M) receptacle. Unscrew the nut from the terminal stud (W) of the starter switch assembly (V) terminal stud (W) and remove the lockwasher, battery-to-starter cable assembly 82 (Q), and generator regulator-to-starter cable 4 (P), and remove the cable from the clip on the shield (J).
- (3) Unscrew the four lockwasher screws (fig. 93) from the generator regulator mounting brackets, and remove the regulator with brackets and cable from the vehicle. Unscrew the sheet metal screw from the shield (J) and remove the shield.
- (4) Disconnect cable 12 (N) from the wiring harness receptacle on the distributor housing, by unscrewing the nut (X) from the receptacle.
- (5) Disconnect cable 33 (R) from the engine water temperature sending unit assembly (S) and cable 36 (T) from the engine oil pressure sending unit assembly (U).
- (6) Unscrew the lockwasher nuts (F) and remove the bolts and flat washers from the front mounting support cushion assembly (E) and the frame bracket (G).
- (7) Loosen the screw in the throttle control wire stop with screw assembly (M, fig. 64) and remove the stop from the wire.

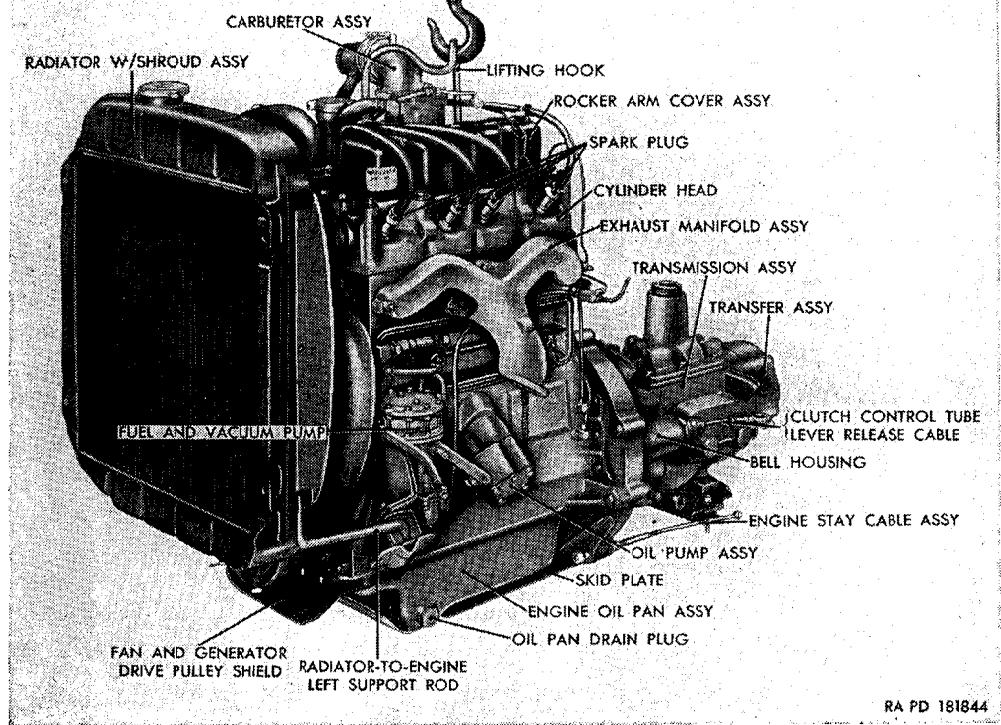

*Figure 52. Power plant removed—left front view.*

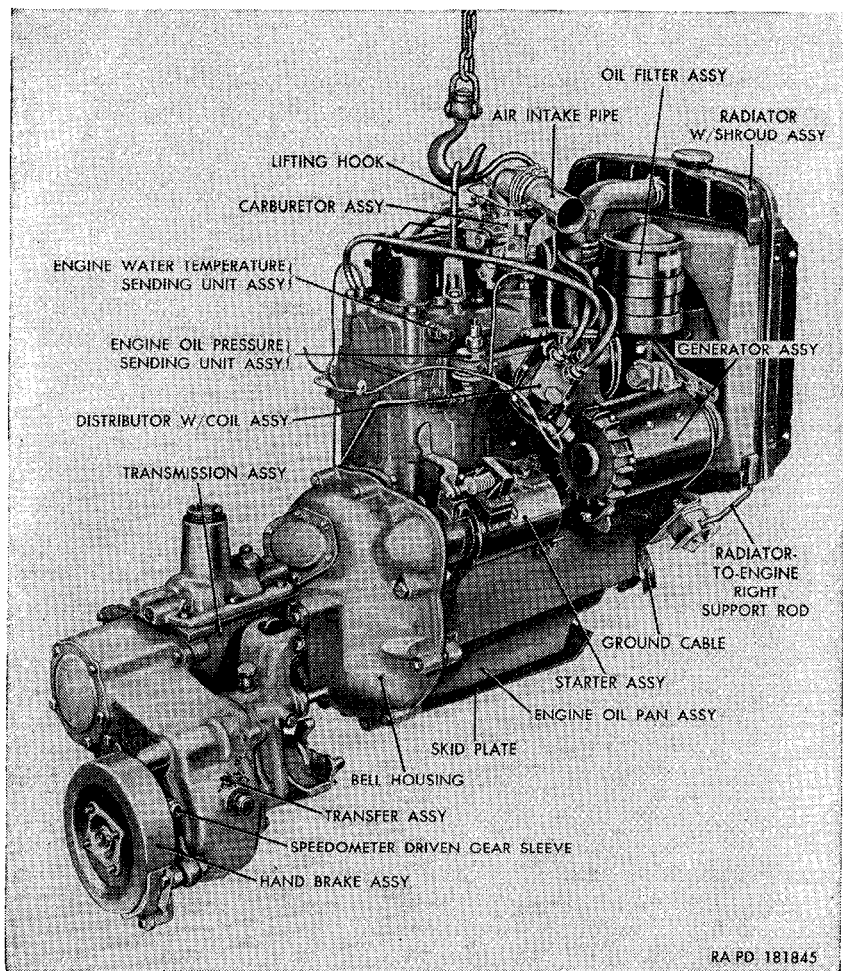

*Figure 53. Power plant removed—right rear view.*

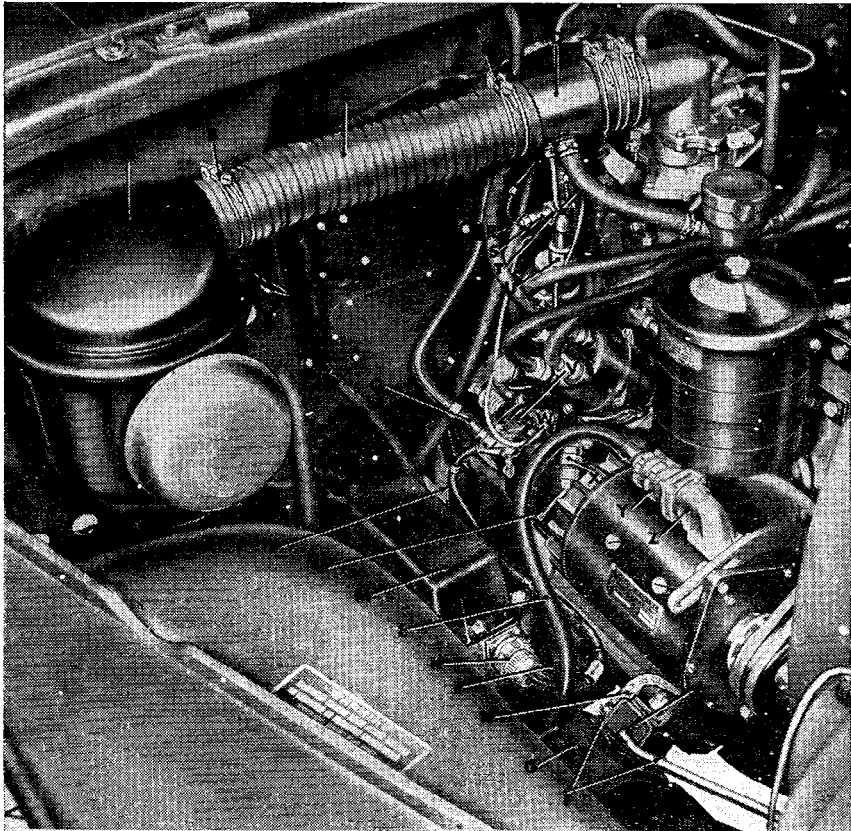

- |  |  |
|--|--|
| A—AIR CLEANER ASSY                             | N—CABLE 12                                   |
| B—HOSE CLAMP                                   | P—GENERATOR REGULATOR-TO-STARTER CABLE       |
| C—AIR CLEANER-TO-AIR INTAKE PIPE FLEXIBLE HOSE | Q—BATTERY-TO-STARTER CABLE 82                |
| D—AIR INTAKE PIPE                              | R—CABLE 33                                   |
| E—FRONT MOUNTING SUPPORT CUSHION ASSY          | S—ENGINE WATER TEMPERATURE SENDING UNIT ASSY |
| F—LOCKWASHER NUT                               | T—CABLE 36                                   |
| G—BRACKET                                      | U—ENGINE OIL PRESSURE SENDING UNIT ASSY      |
| H—GROUND STRAP                                 | V—STARTER SWITCH ASSY                        |
| J—SHIELD                                       | W—TERMINAL STUD                              |
| K—CONNECTOR                                    | X—NUT  |
| L—GENERATOR-TO-GENERATOR REGULATOR CABLE       | Y—CONNECTOR                                  |
| M—GENERATOR REGULATOR ASSY                     | Z—GENERATOR RECEPTACLE                       |

RA PD 181846

Figure 54. Power plant removal—disconnect points right side of vehicle.

Loosen the screw from the nut in the throttle control assembly (D, fig. 64) clamp. Pull the throttle control assembly out of the clamp and the throttle rod (L, fig. 64) pivot. Loosen the bolt (R, fig. 64) from the nut in the choke control conduit clamp (Q, fig. 64). Loosen the set screw (V, fig. 64) from the choke valve lever pivot (U, fig. 64). Pull the choke control assembly out of the pivot and clamp.

*c. Left Side Disconnections.*

*Note.* The key letters noted in parentheses refer to figure 55; except where otherwise indicated.

- (1) Turn the fuel shutoff valve (Q) to the OFF position. Unscrew the nut (N) from the flexible fuel line (M).
- (2) Pull the air regulating valve-to-distributor tee line hose (E) off the tee-to-windshield wiper line (D).
- (3) Unscrew the two nuts securing the exhaust pipe (H) to the exhaust manifold assembly (G) and remove the bolt (F). Separate the flanges and discard the exhaust pipe flange gasket.
- (4) Remove a cotter pin and flat washer and separate the throttle rod adjusting block (B) from the accelerator lower bellcrank

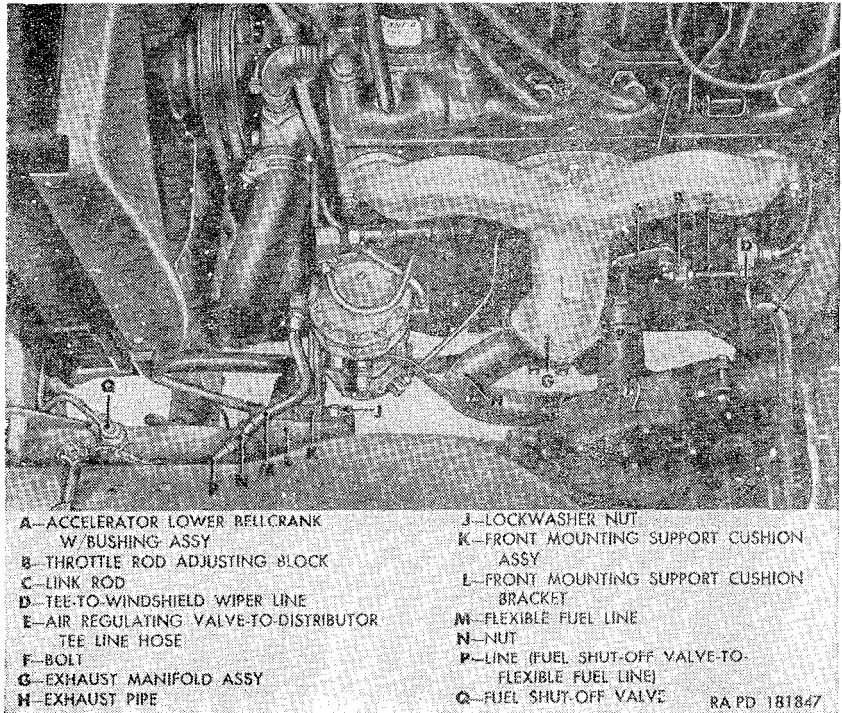

Figure 55. Power plant removal—disconnect points left side of vehicle.

with bushing assembly (A). Push the link rod (C) up through the upper front floor pan cover into the driver's compartment.

- (5) Unscrew the two lockwasher nuts (J) and remove the bolts and flat washers from the front mounting support cushion assembly (K) and the bracket (L).

*d. Driver's Compartment Disconnections.*

*Note.* The key letters noted in parentheses refer to figure 56, except where otherwise indicated.

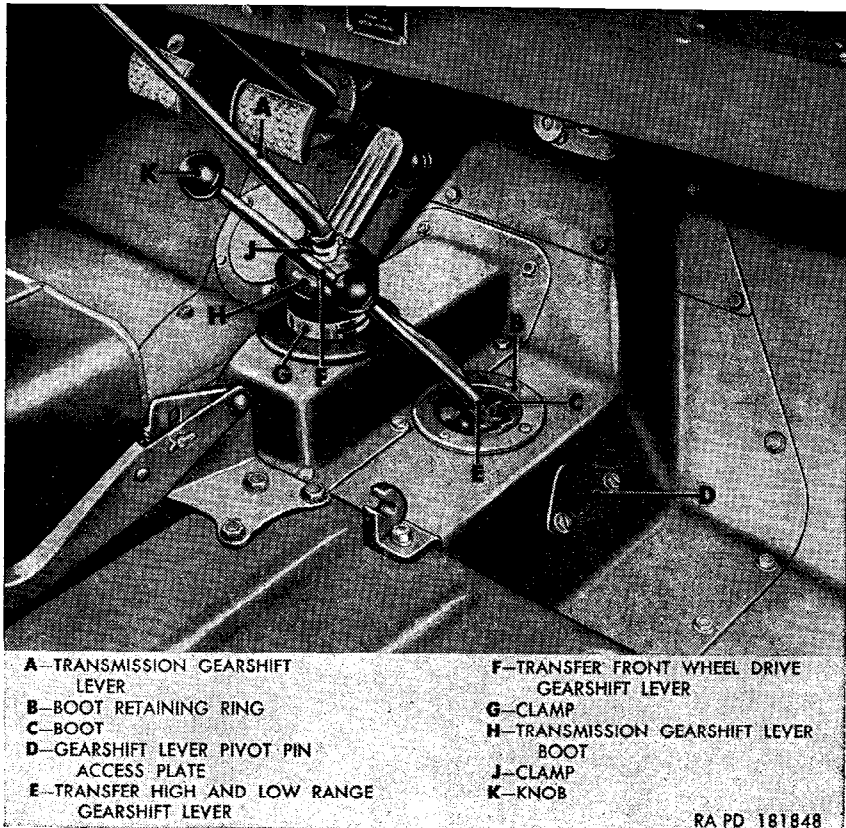

Figure 56. Power plant removal disconnect points—driver's compartment.

- (1) Remove the gearshift lever knob from the transmission gearshift lever (A) and the knobs (K) from the transfer high and low range gearshift lever (E) and the transfer front wheel drive gearshift lever (F).
- (2) Remove the sheet metal screws from the boot retaining ring (B) and slide the boot (C) up and off the levers. Loosen the screw in the clamp (G). Loosen the clamp (J) and remove the transmission gearshift lever boot (H) and the clamps from the lever.
- (3) Loosen the lockwasher screws in the transfer gearshift lever pivot pin access plate (D) and swing the plate back. Reach through the opening and unscrew the gearshift lever pivot pin (J, fig. 57). Pull the pin with lockwasher (H, fig. 57) out through the opening, and remove the gearshift levers and springs (N, fig. 57).
- (4) Unscrew the transmission gearshift lever housing cap from the housing and remove the lever. Stuff a clean rag in the housing opening.

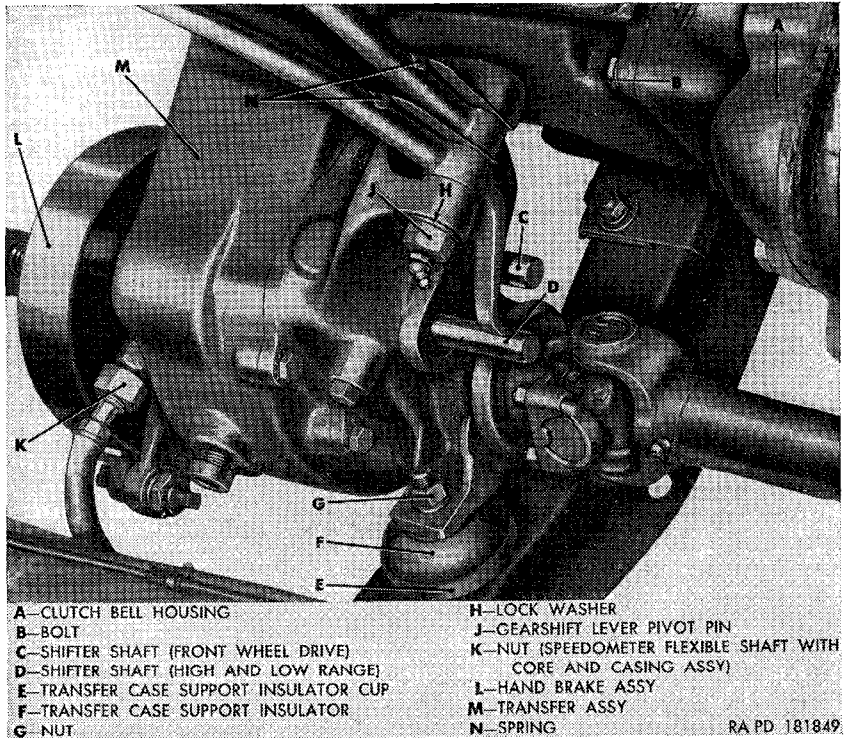

Figure 57. Power plant removal—transfer disconnect points.

*e. Under-the-Vehicle Disconnections.*

*Note.* The key letters noted in parentheses refer to figure 58, except where otherwise indicated.

- (1) Disconnect the rear end of the front propeller shaft (par. 202a(1)), and the front end of the rear propeller shaft (par. 202b(1)).
- (2) Unhook the spring (K) from the skid plate (J) and the brake rod adjusting yoke (F). Remove the cotter pin and separate the clevis pin (H) from the yoke and hand brake cam lever (G).
- (3) Remove the two lockwasher nuts (L) and flat washers from the studs of the engine rear mounting support cushion with studs assembly (M).
- (4) Remove the lockwasher nut on the stay cable assembly (P) and remove the cable. Unhook the service brake pedal retracting spring (T) from the bracket (R). Remove the cotter pin and clevis pin from the control tube lever release cable yoke (V).
- (5) Unscrew the transfer case support insulator snubber bolt from the nut (G, fig. 57) on top of the right side of the engine



rear support cross member (Q) and remove the lockwasher. Pull the bolt with two flat washers and the snubber out of the transfer case support insulator (F, fig. 57) and the cross member. Unscrew the nut (K, fig. 57) on the end of the speedometer flexible shaft with core and casing assembly (E) from the transfer speedometer drive gear sleeve, and remove shaft with core and casing assembly from the sleeve.

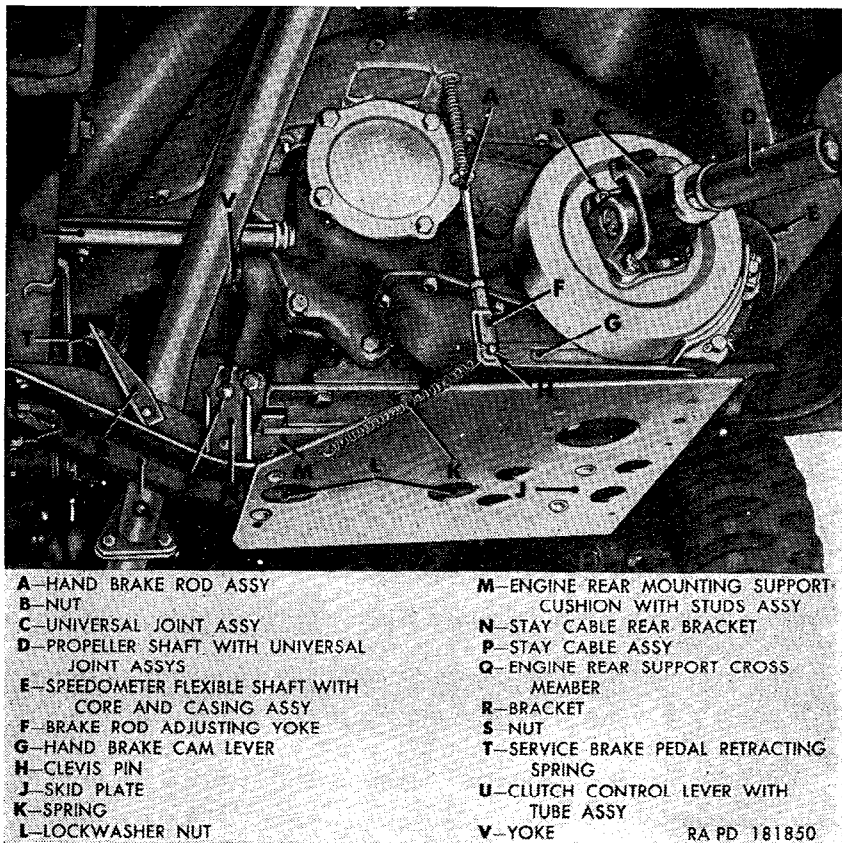

Figure 58. Power plant removal—disconnect points under vehicle.

- (6) Place a jack under the clutch bell housing to support the power plant rear end. Unscrew the two nuts (S) from the bolts on the right and left side of the vehicle, remove the lockwashers, the engine rear support cross member (Q) with the skid plate (J) and the bolts.

*f. Lifting Power Plant From Vehicle (fig. 59).*

**Caution:** Before lifting power plant from vehicle, turn the front wheels to the extreme right to permit the power plant to clear the Pitman arm of the steering system.

- (1) Connect a suitable lifting device to the rear eye of the lifting hook. Carefully raise the engine sufficiently to lift the engine front mounting support cushion assemblies from the brackets on the frame.
- (2) Using a pry bar, slide the power plant rear toward the vehicle right side until the clutch control lever with tube assembly (U, fig. 58) is off the control lever tube ball stud on the transfer.
- (3) Raise the power plant sufficiently to clear the frame front cross member, and roll the vehicle back while guiding the power plant out of the vehicle. Place the power plant on a suitable stand.

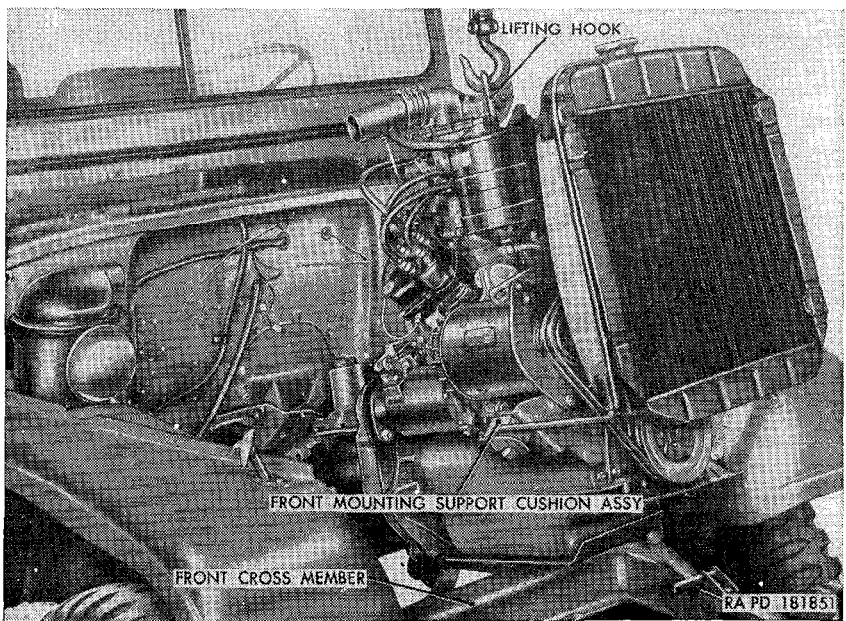

Figure 59. Lifting power plant from vehicle.

## 121. Power Plant Removal (M170)

(fig. 54)

Procedures for power plant removal of the M170 are the same as those for the M38A1 (par. 120) except for substituting *a* and *b* below for paragraph 120*b*(2) and (3).

*a.* Unscrew the connector (Y) from the generator receptacle (Z). Unscrew the nut from the starter switch assembly (V) terminal stud (W) and remove the lockwasher, battery-to-starter cable assembly 82 (Q), and the generator regulator-to-starter cable 4 (P).

*b.* Remove the two sheet metal screws and flat washers from the shield (J) and remove the shield.

## 122. Engine Removal From Power Plant

*a.* Remove the transmission and transfer by separating the transmission from the engine (par. 195*c* through *g*).

*b.* Drain the cooling system (par. 127*a*(1)) and remove the radiator with shroud assembly (par. 128*a*).

## 123. Engine Installation on Power Plant

*a.* Install the radiator with shroud assembly on the power plant (par. 128*b*).

*b.* Install the transmission and transfer on the engine by connecting the transmission to the engine (par. 196*a* through *e*).

## 124. Power Plant Installation (M38A1)

*a.* *Lowering Power Plant Into Vehicle* (fig. 59).

**Caution:** Before lowering the power plant into the vehicle, turn the front wheels to the extreme right to permit the power plant to clear the steering system Pitman arm.

- (1) Connect a suitable lifting device to the lifting hook rear eye. Raise the power plant sufficiently to clear the frame front cross member.
- (2) Roll the vehicle forward and lower the power plant into the engine compartment, tilting the power plant rear end down. Place a jack under the clutch bell housing and raise the power plant rear end sufficiently to align the transfer ball stud with the clutch control lever with tube assembly (U, fig. 58).
- (3) Using a pry bar, slide the power plant to the left and guide the control lever onto the ball stud.

*b.* *Under-the-Vehicle Connections.*

**Note.** The key letters noted in parentheses refer to figure 58, except where otherwise indicated.

- (1) Position the engine rear support cross member (Q) with the skid plate (J) under the rear of the power plant. Position the transfer case support insulator cup, insulator, and 1/2-inch washer on the right side of the cross member. Raise the cross member and guide the studs in the engine rear mounting support cushion with studs assembly (M) through the holes in the cross member. Insert two 3/8-inch bolts through the frame side rail and the cross member on both sides of the vehicle. Install a 3/8-inch lockwasher and 3/8-inch nut on each bolt.
- (2) Place a 1/2-inch flat washer, the transfer case support insulator snubber, and a 1 7/32-inch ID flat washer on the 1/2-inch transfer case support insulator bolt. Push the bolt through

the cross member, the case support insulator retaining cup, the case support insulator, the 1/2-inch washer, and through the hole in the transfer case support. Install a 1/2-inch lockwasher and 1/2-inch nut (G, fig. 57). Connect the speedometer flexible shaft with core and casing assembly to the speedometer gear sleeve on the transfer.

- (3) Push the engine stay cable assembly (P) threaded end through the clutch bell housing hole, and slide the opposite end into the stay cable rear bracket (N) slot. Install a 3/8-inch lockwasher nut on the cable. Position the yoke (V) on the clutch control lever, and secure with a 5/16 x 27/32 clevis pin and 3/32 x 1/2 cotter pin.
- (4) Install a 7/16-inch ID flat washer and a 3/8-inch lockwasher nut (L) on each of the two studs of the engine rear mounting support cushion with studs assembly (M).
- (5) Place the brake rod adjusting yoke (F) on the hand brake cam lever (G) and secure with a 5/16-inch clevis pin and 3/32 x 1/2 cotter pin. Hook the spring (K) to the yoke and skid plate (J). Hook the service brake pedal retracting spring (T) into the bracket (R).
- (6) Install the rear end of the front propeller shaft (par. 203a (2)), and the front end of the rear propeller shaft (par 203b (1)).

*c. Driver's Compartment Connections.*

*Note.* The key letters noted in parentheses refer to figure 56, except where otherwise indicated.

- (1) Insert the transmission gearshift lever (A) in the housing and screw the transmission gearshift lever housing cap onto the housing. Slide the boot (C) and clamp (G) over the lever and tighten the screw in the clamp. Slide the clamp (J) over the lever and boot and tighten the clamp.
- (2) Position the transfer high and low range gearshift lever (E) in the shifter shaft (D, fig. 57) slot. Place a 5/8-inch internal-teeth lockwasher on the gearshift lever pivot pin (J, fig. 57). Working through the access plate opening, push the pin into the transfer hole and part way through the lever hole. Position the transfer front wheel drive gearshift lever (F) in the shifter shaft (C, fig. 57) slot and slide the pivot pin through the lever hole. Install the springs (N, fig. 57) over the pivot pin and onto the levers. Screw the pivot pin into the transfer.
- (3) Swing the gearshift lever pivot pin access plate (D) into position and tighten the two lockwasher screws. Slide the boot (C) and the boot retaining ring (B) over the levers and install the four sheet metal screws in the ring.

- (4) Install the transmission gearshift lever knob on the lever. Install the transfer high and low range gearshift lever (E) and the transfer front wheel gearshift lever knobs (K) on the levers.

*d. Left Side Connections.*

*Note.* The key letters noted in parentheses refer to figure 55, except where otherwise indicated.

- (1) Insert two  $\frac{5}{16} \times \frac{7}{8}$  bolts, with flat washers, through the front mounting support cushion bracket (L) and through the front mounting support cushion assembly (K) and secure with a  $\frac{5}{16}$ -inch lockwasher nut on each bolt.
- (2) Pull the link rod (C) down through the upper front floor pan cover and insert the throttle rod adjusting block (B) into the accelerator lower bellcrank with bushing assembly (A). Secure the bellcrank to the block with a No. 8 flat washer and a  $\frac{1}{16} \times \frac{1}{2}$  cotter pin.
- (3) Install the exhaust pipe on the exhaust manifold (par. 146b(1) and (3)).
- (4) Push the air regulating valve-to-distributor tee line hose (E) onto the tee-to-windshield wiper line (D).
- (5) Screw the nut (N) on the line (P) into the flexible fuel line (M) and turn the fuel shutoff valve (Q) to the ON position.

*e. Right Side Connections.*

*Note.* The key letters noted in parentheses refer to figure 54, except where otherwise indicated.

- (1) Push the choke control assembly (P, fig. 64) through the choke control conduit clamp (Q, fig. 64) and the choke valve lever pivot (U, fig. 64). Make certain that the choke control on the instrument panel is pushed in. Tighten the screw in the pivot and clamp.
- (2) Push the throttle control assembly (D, fig. 64) through the throttle control conduit clamp and the throttle rod (L, fig. 64) pivot. Make certain the throttle control on the instrument panel is pushed in. Slide the throttle control wire stop with screw (M, fig. 64) on the control wire (S, fig. 64) up to the throttle rod (L, fig. 64) pivot. Slide the stop off the wire slightly and tighten the screws in the stop and clamp.
- (3) Insert a  $\frac{5}{16} \times \frac{7}{8}$  bolt, with  $\frac{5}{16}$ -inch flat washer, through the bracket (G) and the front mounting support cushion assembly (E) at the front of the cushion, and secure with a  $\frac{5}{16}$ -inch lockwasher nut (F). Insert a  $\frac{5}{16} \times \frac{7}{8}$  bolt, with  $\frac{5}{16}$ -inch flat washer, through the frame bracket (G) and the front mounting support cushion assembly (E). Place a  $\frac{5}{16}$ -inch internal- and external-teeth lockwasher and ground

strap (H) over the bolt and secure with a  $\frac{5}{16}$ -inch lockwasher nut (F).

- (4) Connect cable 33 (R) to the engine water temperature sending unit assembly (S) and cable 36 (T) to the engine oil pressure sending unit assembly (U).
- (5) Insert the terminal plug of cable 12 (N) into the wiring harness receptacle on the distributor housing and secure by tightening nut (X).
- (6) Position the shield (J) on the frame side rail and the generator regulator mounting brackets on the frame, and insert but do not tighten a sheet metal screw through the shield and into the frame. Position the generator regulator assembly (M) with the mounting brackets on the shield.
- (7) Install the four lockwasher screws through the mounting brackets, shield, and supports on the frame side rail. Tighten the sheet metal screws securing the shield to the frame. Place the generator regulator-to-starter cable 4 (P), the battery-to-starter cable 82 (Q), and a  $\frac{3}{8}$ -inch lockwasher on the starter switch terminal stud (W) in the order named. Secure with a  $\frac{3}{8}$ -inch nut. Insert cable 4 in the clip on the shield (J) and install connector (K) on the receptacle of the generator regulator assembly (M). Connect the generator-to-generator regulator cable (L) to the generator receptacle (Z).
- (8) Install the air cleaner-to-air intake pipe flexible hose (C) and tighten the screws in the two hose clamps (B).

*f. Final Operations.*

- (1) Install the radiator guard (par. 257*b*).
- (2) Push the ground cable (fig. 99) through the grommet in the battery box and position the cable end on the negative post terminal of battery B. Secure with a  $\frac{3}{8}$ -inch nut.
- (3) If a new power plant was installed, fill the cooling system (par. 127*a*(2)), fill the transmission, transfer, and crankcase (par. 69).
- (4) Install the hood (par. 255*d*).
- (5) Start the engine and check for proper operation, and fuel, oil, or water leaks.
- (6) Make a record of replacement on DA Form 478.

## **125. Power Plant Installation (M170)**

(fig. 54)

Procedures for the power plant installation of the M170 are the same as those for the M38A1 (par. 124) except for substituting *a* and *b* below for paragraph 124*e*(6) and (7).

*a.* Position the shield (J) on the frame side rail and install the two sheet metal screws and flat washers securing the shield to the frame.

b. Place the generator regulator-to-starter cable 4 (P), the battery-to-starter cable 82 (Q), and a 3/8-inch lockwasher on the starter switch terminal stud (W) in the order named, and secure with a 3/8-inch nut. Connect the generator-to-generator regulator cable (L) to the generator receptacle (Z).

## Section VII. COOLING SYSTEM

### 126. Description and Data

a. *Description.* The cooling system (fig. 60) includes the radiator, fan, water pump, water temperature thermostat, fan and generator drive belts, and connecting hose and fittings. The radiator is the cellular-type with upper and lower tanks. A pressure-type filler neck cap permits cooling system pressure to rise to 4½ psi. The four-blade fan and the centrifugal-type water pump are driven from the generator drive pulley by a matched pair of V-belts. The water temperature thermostat is a bellows-type, located on top of the cylinder head in the thermostat housing. With the coolant below normal operating temperature (160° to 180° F.), the thermostat blocks coolant return to the top of the radiator, returning the coolant directly to the pump through the water pump bypass.

b. *Data.*

Radiator:

Manufacturer..... Blackstone  
 Type..... cellular  
 Capacity..... 11½ qt  
 Filler cap..... 4½ psi pressure-type

Water pump and fan:

Water pump type..... centrifugal  
 Fan..... four blade, 15 in. diam  
 Drive..... double V-belts  
 Location..... front of cylinder block

Drive belts:

Type..... V, matched pair  
 Width..... 3/8 in.

Thermostat:

Location..... Thermostat housing  
 Range (opening)..... 148°-155° F.

### 127. Organizational Maintenance

**Caution:** The cooling system is pressurized. Be sure the engine coolant temperature is below 200° F., before loosening or removing filler cap.

a. *Draining and Filling.*

- (1) *Draining.* Open the hood and loosen filler neck cap to relieve pressure in the cooling system. Remove the filler cap. If coolant is to be saved, place suitable containers under the

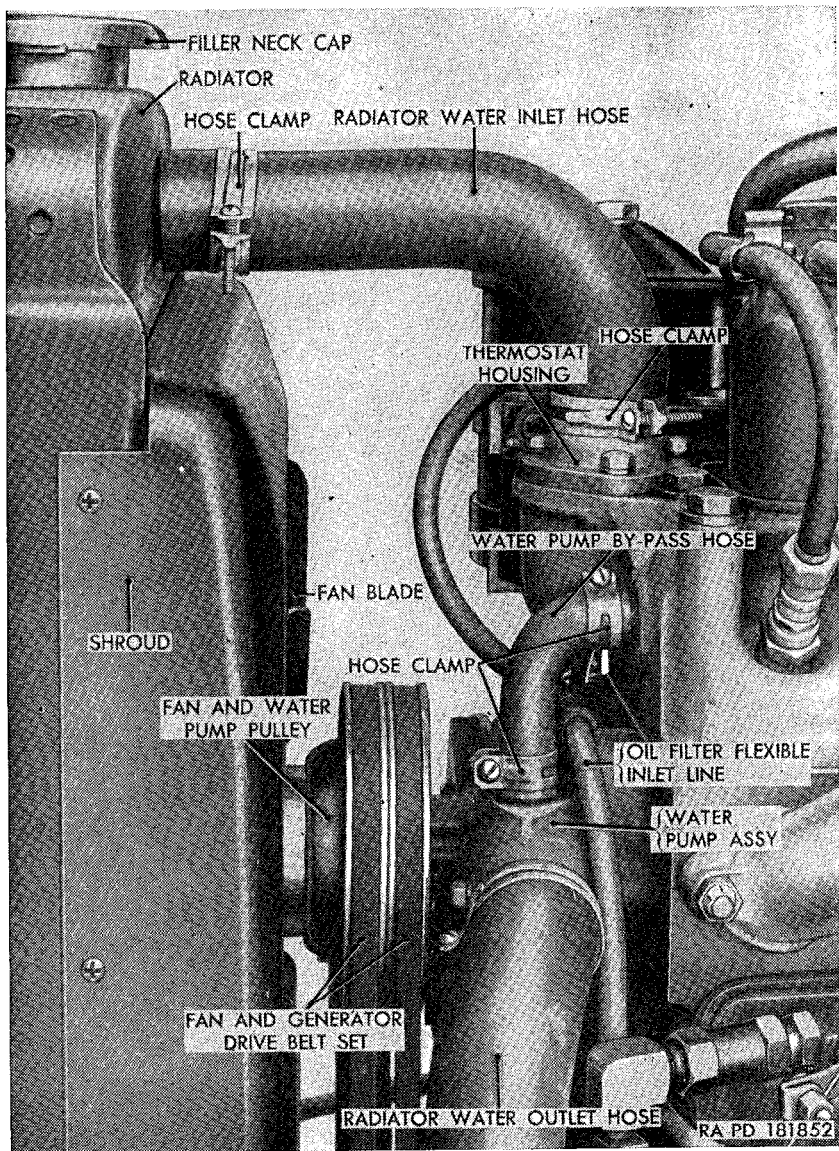

Figure 60. Cooling System.

drain cocks (fig. 61). Open both drain cocks, allow system to drain completely, and close drain cocks.

- (2) *Filling.* Be sure both drain cocks (fig. 61) are closed. Fill the cooling system with water, or antifreeze solution of sufficient strength to protect the system against the lowest anticipated temperature, to a level one inch below the filler neck. Be sure rust inhibitor is added to prevent the formation of



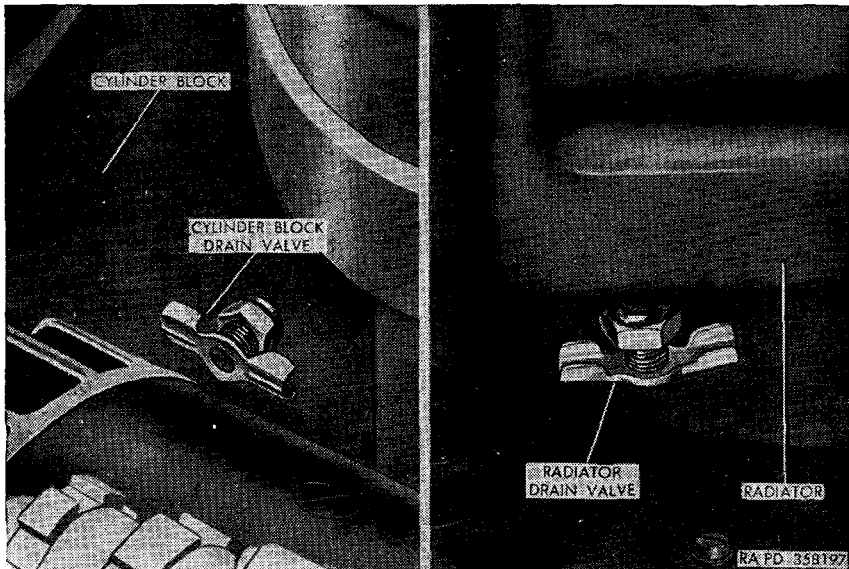

Figure 61. Cooling system drain cocks.

rust. Run the engine to circulate the coolant and expel air from the system, and recheck the coolant level.

*b. Cleaning and Flushing.* For directions on cleaning and flushing, refer to TM 9-2858.

## 128. Radiator With Shroud Assembly

### *a. Removal.*

- (1) Drain the cooling system (par. 127*a*(1)) and remove the radiator guard (pars. 257*a* for the M38A1 and 266*a* for the M170).
- (2) Loosen the hose clamp screws on the radiator water inlet and water outlet hose (fig. 60) and pull hose from connections on radiator.
- (3) Lift the radiator with shroud assembly off the radiator-to-engine support rods, taking care that the radiator core does not rub against the fan blade.

### *b. Installation.*

- (1) Lift the radiator with shroud assembly into position in front of the fan, being careful not to damage the radiator core. Insert the ends of the radiator-to-engine support rods into the brackets on the bottom of the radiator.
- (2) Slip the radiator water inlet and outlet hoses over the connections on the radiator, and tighten the hose clamp screws.
- (3) Install the radiator guard (pars. 257*b* and 266*b*) and fill the cooling system (par. 127*a*(2)).

## 129. Coolant Hose

(fig. 60)

### a. Radiator Water Inlet Hose.

- (1) *Removal.* Drain the cooling system (par. 127a(1)) sufficiently to lower the level of the coolant below the thermostat housing. Loosen the screw in the radiator water hose clamp and pull the end of the radiator water inlet hose from the connection on top of the radiator. Loosen the screw in the hose clamp and remove the hose with clamps from the thermostat housing. Remove the clamps from the hose.
- (2) *Installation.* Make sure the connections at radiator and thermostat housing are clean and free of rust or scale. Place a radiator water hose clamp on each end of the radiator water inlet hose. Push one end of the hose over the thermostat housing and the other over the connection on top of the radiator. Tighten the screws in the clamps. Refill the cooling system (par. 127a(2)) and check all connections for leaks.

### b. Radiator Water Outlet Hose.

- (1) *Removal.* Drain the cooling system (par. 127a(1)). Loosen the screw in the radiator water hose clamp and pull the end of the radiator water outlet hose from the connection on the bottom of the radiator. Loosen the screw in the clamp and remove the hose with clamps from the connection on the water pump. Remove the clamps from the hose.
- (2) *Installation.* Make sure connections at the radiator and water pump are clean and free of rust or scale. Place a radiator water hose clamp on each end of the radiator water outlet hose. Push one end of the hose over the connection on the bottom of the radiator and the other end over the connection on the water pump. Tighten the screws in the clamps. Fill the cooling system (par. 127a(2)) and check all connections for leaks.

### c. Water Pump Bypass Hose.

- (1) *Removal.* Drain the cooling system (par. 127a(1)). Loosen the screws in the water pump bypass hose clamps. Pull one end of the hose from the connection on top of the water pump. Remove the hose with clamps from the water bypass hose nipple in the cylinder head. Remove the clamps from the hose.
- (2) *Installation.* Make sure water bypass hose nipple and connection on top of water pump are clean and free of rust or scale. Place hose clamp on each end of the water pump bypass hose. Push one end of the hose over the connection on the top of the water pump and the other end over the

nipple. Tighten the screws in the hose clamps. Fill the cooling system (par. 127a(2)) and check all connections for leaks.

### 130. Fan and Generator Drive Belt Set

(fig. 62)

a. *Adjustment.* Loosen the lockwasher bolt securing the generator belt tension brace to the generator drive end head. Place a straight-edge over the fan and generator drive belts between the fan and water pump pulley and the generator drive pulley. Move the generator until the drive belts have a measured  $\frac{3}{4}$ -inch deflection, as a result of

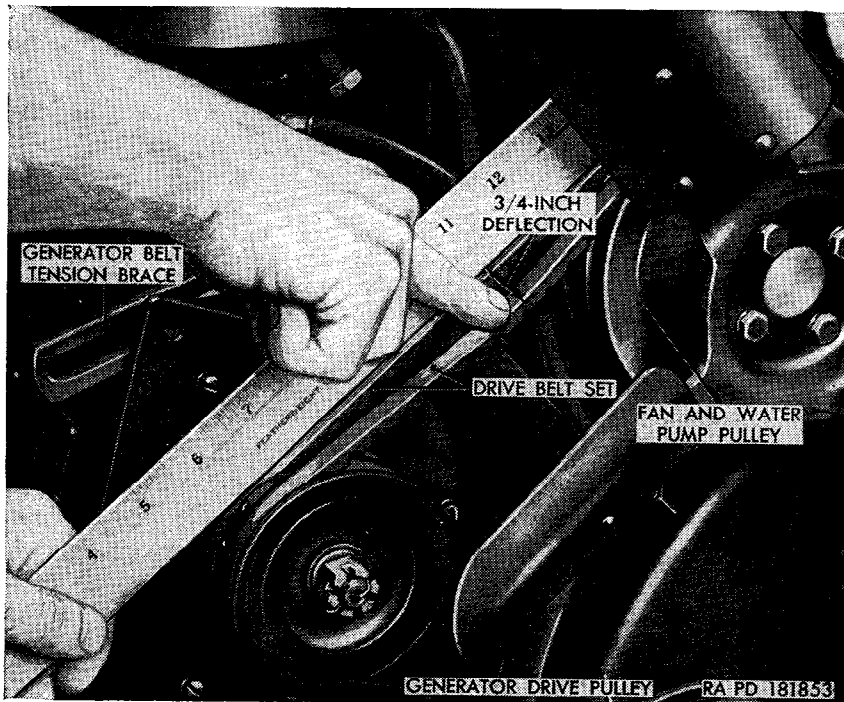

Figure 62. Adjusting fan and generator drive belt set.

a firm push, as shown in figure 62. When adjustment is correct, tighten the lockwasher bolt securing the generator belt tension brace to the generator drive end head.

b. *Removal.* Loosen the lockwasher bolt securing the generator belt tension brace to the generator drive end head, and push the generator toward the engine as far as possible. Work the front fan and generator drive belt over the front edge of the generator drive pulley. When free, slip the belt over the fan blade and off the fan and water pump pulley. Work the rear belt into the front grooves of both pulleys, and follow the procedure used to remove the front bolt.

*c. Installation.* Place one fan and generator drive belt over the fan blade and into the front groove of the fan and water pump pulley. Work the belt into the rear grooves of the generator drive pulley and fan and water pump pulley. By the same method, place the second belt in the front grooves of both pulleys. When the belts are in place, adjust their tension (*a* above).

### **131. Removing Fan and Water Pump Pulley From Water Pump Assembly**

*a. Removal* (fig. 60).

- (1) Remove the radiator with shroud assembly (par. 128*a*). Loosen the hose clamps screw on the water pump end of the radiator water outlet hose, and remove hose with clamp from connection on the water pump. Loosen the hose clamp screw on the water pump end of the water pump bypass hose. Remove the fan and generator drive belt set (par. 130*b*).
- (2) Remove the four bolts and lockwashers securing the fan blade to the fan and water pump pulley, and remove fan blade.
- (3) Remove the four screws and lockwashers securing the water pump to the cylinder block. Pull the pump with pulley and gasket from the cylinder block, at the same time, slipping the connection on the water pump out of the end of the water pump bypass hose. Discard gasket.
- (4) Clamp the water pump in a vise with soft jaws. Using puller—41-P-2908-240 (fig. 63), remove the pulley from the pump.

*b. Installation.*

- (1) Place the fan and water pump pulley on the end of the water pump shaft and press it onto the shaft until the front face of the pulley hub is flush with the end of the shaft.
- (2) Make sure the gasket surfaces of the cylinder block and water pump body are clean and free of rust or scale. Place a new gasket on the water pump body with the gasket holes aligned with the bolt holes in the water pump body.
- (3) Position the water pump assembly (fig. 60) in the opening in the front of the cylinder block, at the same time, sliding the water pump bypass hose with clamp over the connection on the water pump.
- (4) Insert a  $\frac{5}{16} \times 2\frac{1}{2}$  screw, with lockwasher, through the hole in the water pump body inlet opening. Start the threads but do not tighten. Insert a  $\frac{9}{16} \times \frac{7}{8}$  screw, with lockwasher, into the top mounting hole in the water pump body and through the clip securing the flexible oil line to the cylinder block, and start the threads. Insert two  $\frac{5}{16} \times \frac{7}{8}$  screws, with lock-

- washers, into the other two holes in the water pump body, and tighten the four screws evenly and securely. Tighten the screw in the hose clamp of the water pump bypass hose.
- (5) Place the fan on the front of the fan and water pump pulley with the concave side of the blades toward the engine. Secure the fan blade to the pulley with four  $\frac{1}{4}$  x  $\frac{5}{8}$  bolts and lockwashers.

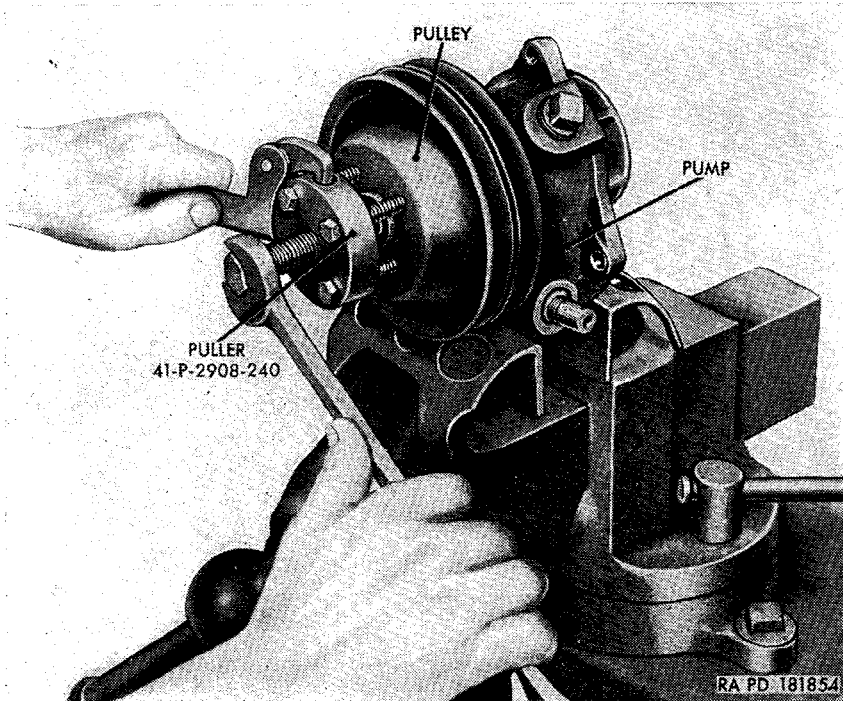

Figure 63. Removing fan and water pump pulley from water pump assembly, using puller—41-P-2908-240.

- (6) Install the fan and generator drive belt set (par. 130c), place the end of the radiator water outlet hose, with clamp, over the connection on the water pump and tighten the screw in the clamp.
- (7) Install the radiator with shroud assembly (par. 128b).

## 132. Water Temperature Thermostat

*a. Removal.* Drain the cooling system (par. 127a(1)) sufficiently to lower the level of the coolant below the thermostat housing. Remove the three screws and lockwashers securing the thermostat housing (fig. 60) to the cylinder block. Lift the end of the radiator water inlet hose, with thermostat housing and gasket attached, from the

cylinder block. Lift the thermostat out of its seat in the cylinder block. Discard gasket.

*b. Installation.* Be sure the gasket surfaces on the cylinder block and thermostat housing are clean and free of rust or scale. Place the thermostat in position in the cylinder block. Place a new gasket on the cylinder block with holes alined. Position the thermostat housing, with radiator water inlet hose attached, on the cylinder block. Secure the thermostat housing to the cylinder block with three  $\frac{3}{8} \times 1\frac{1}{8}$  screws and lockwashers. Refill the cooling system (par. 127a(2)). Check the thermostat operation by running the engine with filler neck cap removed, and watching the radiator coolant. Coolant flow should start when an operating temperature of 160° F., is reached.

## Section VIII. FUEL AND AIR INTAKE SYSTEM

### 133. Description and Data

#### *a. Description.*

- (1) *General.* The fuel and air intake system includes the carburetor, fuel and vacuum pump, air cleaner, accelerator throttle and choke controls, fuel filter, fuel tank, fuel level gage, fuel level sending unit, and fuel lines and fittings.
- (2) *Air cleaner assembly.* The air cleaner assembly (figs. 36 and 37), an oil bath-type with removable element and oil cup, is waterproofed. The assembly is mounted at the right rear of the engine compartment and connected to the carburetor by an air intake pipe and hose.
- (3) *Carburetor assembly.* The carburetor assembly (figs. 36 and 37) is a waterproof, single venturi, downdraft balanced-type. The float chamber and all control and adjustment points are fully sealed. The carburetor assembly is mounted on the right side of the engine and connects directly to a built-in intake manifold.
- (4) *Fuel and vacuum pump.* The fuel and vacuum pump (M, fig. 67) is a diaphragm-type. It provides a constant flow of fuel to the carburetor when the engine is running and a constant vacuum to operate the windshield wiper motors. The fuel pump is equipped with a hand priming lever. The pump is mounted on the left side of the cylinder block at the front of the engine.
- (5) *Fuel tank.* The fuel tank (B, fig. 69 and fig. 70) is located on the left side of the vehicle under the driver's seat. The filler cap with chain assembly is located in a left side recess of the body panel. The fuel level sending unit is mounted in the top of the fuel tank.

- (6) *Fuel filter assembly.* The fuel filter assembly (H, fig. 69 and fig. 70), mounted on top of the fuel tank, consists of a filter element and cover plate with filter bracket and vent assembly.
- (7) *Fuel lines and fittings* (fig. 72). The fuel lines and fittings include a flexible fuel line, fuel lines, elbows, connectors, nuts, clips, and a fuel shutoff valve. The shutoff valve is in the line between the tank and the pump, and is located on the vehicle left side over the frame side rail top and between the front fender and the radiator.

### b. Data.

#### Carburetor assembly:

Manufacturer----- Carter  
 Model----- YS 950 S  
 Type----- downdraft  
 Venturi----- single  
 Adjustments----- mixture and speed

#### Fuel and vacuum pump:

Manufacturer----- AC Spark Plug Div GMC  
 Model----- AC-GP 1539810  
 Type----- diaphragm  
 Drive----- camshaft  
 Pressure----- 4½-5 psi at 1,800 rpm  
 Vacuum----- 10 in. at 200 rpm, 12 in. at 1,500 rpm

#### Air cleaner assembly:

Manufacturer----- United Specialties  
 Type----- oil bath  
 Capacity----- 1½ pt

#### Fuel tank:

Capacity----- 17½ gal  
 Type----- pressurized  
 Filler cap w/chain assembly----- pressurized

## 134. Carburetor Assembly

*Note.* The key letters noted in parentheses refer to figure 64, except where otherwise indicated.

### a. Adjustments.

- (1) *Air-fuel mixture adjustment.* With the engine running at normal operating temperature (160° to 180° F.), and at an idle speed of approximately 600 rpm, turn the idle adjusting screw (H) until the engine idles smoothly and evenly.

**Caution:** Do not jam the idle adjusting screw against the seat in the carburetor as the seat and the idle adjusting screw threads are easily damaged. If the screw is damaged, a new screw must be installed before satisfactory adjustment can be made. If the seat is damaged, replace the carburetor assembly.

- (2) *Idle speed adjustment.* With the engine running at normal operating temperature (160° to 180° F.), turn the throttle

valve lever stop adjusting screw (J) in a clockwise direction to increase and a counterclockwise direction to decrease the engine speed.

*b. Removal.*

- (1) Loosen the screw in the hose clamp (C, fig. 66) at the carburetor.

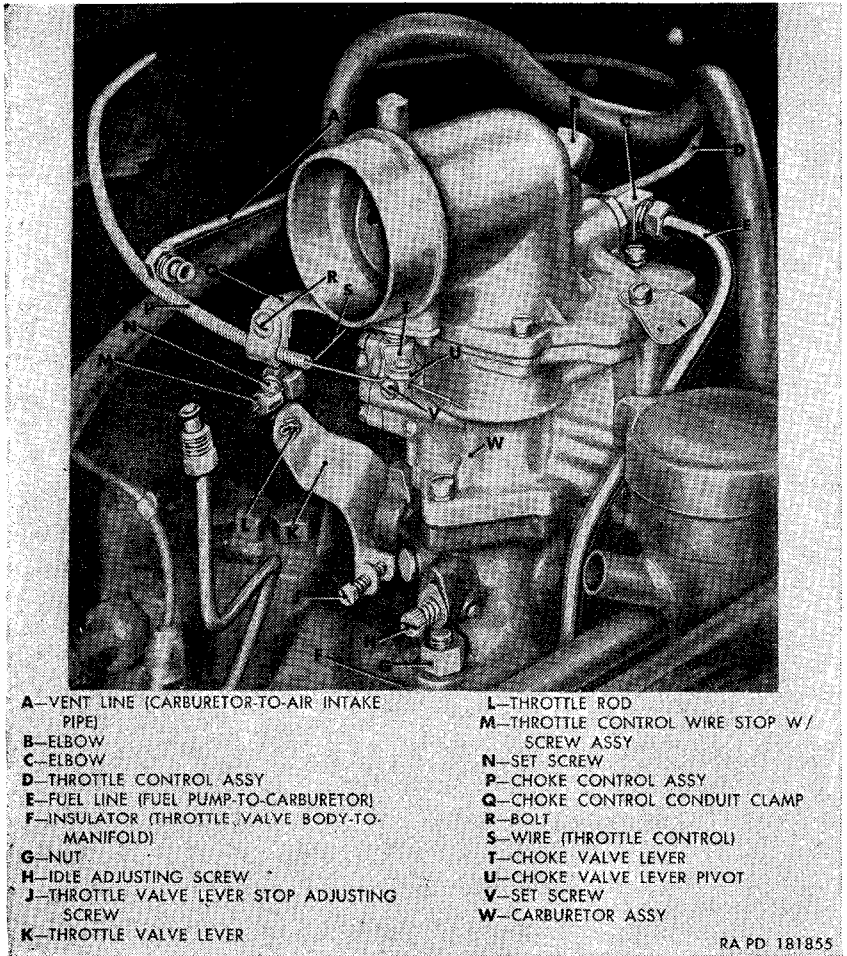

*Figure 64. Carburetor assembly installed—air intake pipe removed.*

- (2) Unscrew the nut on the vent line (A) end from the vent line elbow (B). Unscrew the nut on the fuel line (E) end from the fuel line elbow (C). Remove both elbows.
- (3) Loosen the set screw (V) in the choke valve lever pivot (U). Loosen the bolt (R) from the nut in the choke control conduit clamp (Q), and pull the choke control assembly out of the



pivot and clamp. Remove the two screws and lock washers from the throttle control conduit clamp on the carburetor, and remove the clamp.

- (4) Remove the cotter pin from the throttle rod (L), and slide the rod out of the throttle valve lever (K).
- (5) Unscrew the two nuts (G) from the studs and remove the carburetor assembly from the studs and air intake pipe hose. Remove the insulator (F) from the studs.
- (6) If the carburetor is to be replaced, remove the two elbows (B and C).

*c. Installation.*

- (1) Install the vent line elbow (B) and the fuel line elbow (C) in a new carburetor assembly.
- (2) Position the insulator (F) on the studs in the cylinder head. Position the carburetor assembly (W) on the studs and into the air intake pipe hose and secure with two  $\frac{3}{8}$ -inch nuts (G).
- (3) Slide the choke control assembly (P) through the choke control conduit clamp (Q) and into the choke valve lever pivot (U). Push the choke valve lever (T) forward as far as possible and tighten the set screw (V). Tighten the bolt (R) in the choke control conduit clamp (Q).
- (4) Slide the throttle rod (L) end through the throttle valve lever (K) hole and secure with a  $\frac{1}{16}$  x  $\frac{1}{2}$  cotter pin.
- (5) Position the throttle control conduit clamp on the carburetor and secure with two No. 10 x  $\frac{9}{16}$  screws and lockwashers.
- (6) Install the vent line (A) on the elbow (B) and the fuel line (E) on the elbow (C). Tighten the screw in the hose clamp (C, fig. 66) at the carburetor.
- (7) Adjust the carburetor (*a* above) and check all controls for proper operation.

*d. Throttle Valve Body-to-Manifold Insulator.*

(1) *Removal.*

- (a) Loosen the screw (B, fig. 66) in the hose clamp (C, fig. 66) at the carburetor, and slide the hose (E, fig. 66) off the carburetor assembly.
- (b) Unscrew the nut on the vent line (A) end from the vent line elbow (B). Unscrew the nut on the fuel line (E) end from the fuel line elbow (C).
- (c) Unscrew the two nuts (G) from the studs. Raise the carburetor assembly (W) to clear the studs and remove the throttle valve body-to-manifold insulator (F). Discard insulator.

(2) *Installation.*

- (a) Install a new throttle valve body-to-manifold insulator (F) over the studs in the cylinder head.

- (b) Install the carburetor assembly (W) over the studs and into the air intake pipe hose and tighten the screw (B, fig. 66) in the hose clamp (C, fig. 66). Screw the two  $\frac{3}{8}$ -inch nuts (G) on the studs and tighten evenly.
- (c) Start the engine and warm it up to operating temperature (160° to 180° F.). Check the controls for proper operation and for air leaks around the throttle valve body insulator. Adjust carburetor (*a* above).

### 135. Accelerator, Choke, and Throttle Controls

*Note.* The key letters noted in parentheses refer to figure 65, except where otherwise indicated.

#### *a. Accelerator Pedal Assembly.*

##### (1) *Adjustment.*

- (a) The pedal adjustment is made through the threaded link (E) of the accelerator pedal assembly (F) and the throttle adjusting block (N). Check for proper adjustment ((b) below).
- (b) To check for proper pedal adjustment, remove the cotter pin and flat washer from the throttle adjusting block (N) on the inner side of the accelerator lower bellcrank with bushing assembly (S) and remove the block from the bellcrank. Push the lower lever of the bellcrank to the front of the vehicle as far as possible. Grasping the adjusting block, pull the link (E) toward the front of the vehicle as far as possible or until the pedal is resting on the floor board. The adjusting block should line up with the hole in the accelerator bellcrank. If adjustment is correct, install the block in the bellcrank and install the flat washer and the cotter pin in the block. If adjustment is not correct, adjust ((c) below).
- (c) Unhook the accelerator pedal return spring (T) from the lower bellcrank with bushing assembly (S). Unscrew the adjusting nut (P) and the lock nut (M) sufficiently to permit adjustment. Swing the lower end of the bellcrank (S) toward the front of the vehicle as far as possible. Grasp the adjusting block and pull the link (E) toward the front of the vehicle or until the accelerator pedal is resting on the floor board. Holding the bellcrank and link in this position, install the adjusting block in the bellcrank and install a flat washer and cotter pin in the block. Making sure the bellcrank and link are in the above mentioned positions, screw the adjusting nut and the lock nut up to the block and then tighten the nuts. Hook the

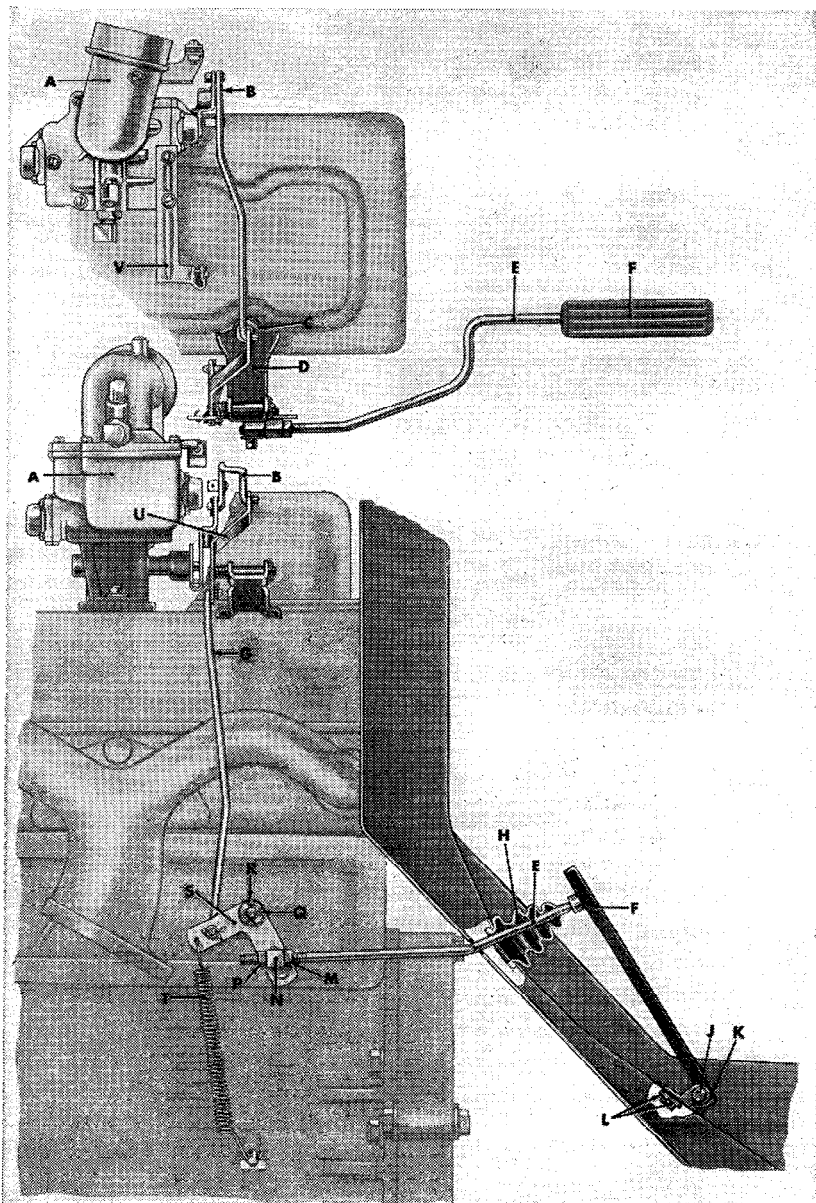

- |                                    |                                     |
|------------------------------------|-------------------------------------|
| A—CARBURETOR ASSY                  | L—NUT                               |
| B—THROTTLE ROD                     | M—LOCK NUT                          |
| C—CYLINDER HEAD SCREW              | N—THROTTLE ADJUSTING BLOCK          |
| D—ACCELERATOR UPPER BELLCRANK ASSY | P—ADJUSTING NUT                     |
| E—LINK (ACCELERATOR PEDAL ASSY)    | Q—FLAT WASHER                       |
| F—ACCELERATOR PEDAL ASSY           | R—COTTER PIN                        |
| G—ACCELERATOR BELLCRANK LINK ROD   | S—LOWER BELLCRANK WITH BUSHING ASSY |
| H—ACCELERATOR LINK BOOT            | T—ACCELERATOR PEDAL RETURN SPRING   |
| J—PIN                              | U—THROTTLE VALVE LEVER              |
| K—ACCELERATOR PEDAL HINGE          | V—THROTTLE CONTROL CONDUIT CLAMP    |

RA PD 181856

Figure 65. Carburetor controls (partial).

accelerator pedal return spring (T) into the bellcrank (S). When properly adjusted, this will provide the maximum engine acceleration.

(2) *Removal.*

- (a) Remove the cotter pin and flat washer from the throttle adjusting block (N) on the inner side of the accelerator lower bellcrank with bushing assembly (S) and pull the block out from the bellcrank.
- (b) Remove the cotter pin and flat washer from the pin (J) and pull the pin out of the accelerator pedal assembly (F) and the accelerator pedal hinge (K).
- (c) Pull the accelerator pedal assembly (F) toward the vehicle rear and out of the accelerator link boot (H).
- (d) Unscrew the adjusting nut (P) from the link (E). Slide the throttle adjusting block (N) off the link. Unscrew the lock nut (M) from the link.

(3) *Installation.*

- (a) Screw the lock nut (M) onto the accelerator pedal assembly link (E). Slide the throttle adjusting block (N) onto the link. Screw the adjusting nut (P) partway onto the link.
- (b) Push the link (E) through the boot (H) and position the pedal in the hinge (K). Position the hinge spring on the hinge and the pedal.
- (c) Push the pin (J) through the hinge, over the hinge spring and through the pedal, install an  $1\frac{1}{32}$ -inch ID flat washer over the pin and a  $\frac{1}{16} \times \frac{1}{2}$  cotter pin in the pin, and spread the ends.
- (d) Position the throttle adjusting block (N) on the bellcrank (S) and install a No. 8 flat washer and a  $\frac{1}{16} \times \frac{1}{2}$  cotter pin on the block at the bellcrank inner side.
- (e) Adjust the accelerator pedal (a(1) above).

b. *Accelerator Pedal Hinge Spring.*

- (1) *Removal.* Remove the accelerator pedal assembly (a(2) (a) through (c) above) and remove the spring.
- (2) *Installation.* Install the accelerator pedal assembly (a(3) (b) and (c) above) and install the spring.

c. *Accelerator Pedal Hinge.*

(1) *Removal.*

- (a) Remove the accelerator pedal assembly (F) (a(2) (a) through (c) above).
- (b) Unscrew the two bolts from the nuts (L) and remove the hinge (K) and the bolts.

(2) *Installation.*

- (a) Position the accelerator pedal hinge (K) on the floor board. Push the two No. 10 x  $\frac{1}{2}$  bolts through the holes in the hinge and the floor board and install the No. 10 nuts (L) on the bolts.
- (b) Install the accelerator pedal assembly (F) (a(3)(b) and (c) above.

d. *Accelerator Lower Bellcrank with Bushing Assembly.*

- (1) *Removal.* Unhook the accelerator pedal return spring (T) from the bellcrank (S). Remove the cotter pin and flat washer from the accelerator bellcrank link rod (G) in the bellcrank (S). Remove the cotter pin and flat washer from the throttle adjusting block (N) on the bellcrank inner side. Remove the cotter pin (R) and flat washer (Q) from the valve compartment screw. Slide the bellcrank and flat washer off the screw.

(2) *Installation.*

- (a) Place an  $\frac{11}{32}$ -inch ID flat washer (Q) over the  $\frac{5}{16}$  x  $2\frac{9}{16}$  valve cover screw, and slide the bellcrank (S) over the screw. Place an  $\frac{11}{32}$ -inch ID flat washer (Q) over the end of the screw, install a  $\frac{1}{16}$  x  $\frac{1}{2}$  cotter pin (R) in the screw hole and spread the pin ends.
- (b) Install the throttle adjusting block (N) through the bellcrank (S) rear hole. Place a No. 8 flat washer over the block end on the bellcrank inner side, install a  $\frac{1}{16}$  x  $\frac{1}{2}$  cotter pin through the block hole, and spread the pin ends.
- (c) Push the accelerator bellcrank link rod (G) end through the bellcrank (S) front hole. Install a No. 8 flat washer over the rod end, install a  $\frac{1}{16}$  x  $\frac{1}{2}$  cotter pin in the rod hole, and spread the pin ends. Hook the accelerator pedal return spring (T) into the bellcrank (S).

e. *Accelerator Bellcrank Link Rod.*

- (1) *Removal.* Remove the cotter pin and flat washer from the rod (G) in the accelerator lower bellcrank with bushing assembly (S). Remove the cotter pin and flat washer from the rod (G) in the accelerator upper bellcrank assembly (D), and remove the rod from the upper and lower bellcranks.
- (2) *Installation.* Install the accelerator bellcrank link rod (G) through the upper and lower bellcrank (S and D) holes and install a No. 8 flat washer over each end of the rod and a  $\frac{1}{16}$  x  $\frac{1}{2}$  cotter pin.

f. *Accelerator Upper Bellcrank Assembly.*

- (1) *Removal.* Remove the cotter pin and flat washer from the accelerator bellcrank link rod (G) on the bellcrank (D). Remove the cotter pin and flat washer from the throttle rod

(B) on the bellcrank (D). Unscrew the cylinder head screw (C) securing the bellcrank to the cylinder head. Remove the screw and the bellcrank from the vehicle.

(2) *Installation.*

- (a) Position the accelerator upper bellcrank assembly (D) on the cylinder head, install a  $\frac{7}{16} \times 4\frac{1}{4}$  cylinder head screw (C) through the hole in the bellcrank bracket, and screw the cylinder head screw in tight.
- (b) Push the accelerator bellcrank link rod (G) end through the bellcrank (D) hole. Place a No. 8 flat washer over the rod end, install a  $\frac{1}{16} \times \frac{1}{2}$  cotter pin through the rod hole, and spread the pin ends.
- (c) Push the throttle rod (B) end through the upper bellcrank assembly (D) hole, place a No. 8 flat washer over the rod end, install a  $\frac{1}{16} \times \frac{1}{2}$  cotter pin through the rod hole, and spread the pin ends.

g. *Throttle Rod.*

(1) *Removal.*

- (a) Remove the cotter pin and flat washer from the throttle rod (B) in the accelerator upper bellcrank assembly (D).
- (b) Remove the throttle control wire stop with screw assembly (*h(2)(a)* below).
- (c) Remove the cotter pin and flat washer from the rod (B) in the throttle valve lever (U). Pull the rod out of the lever and the bellcrank and slide the rod with pivot off the hand throttle control wire of the throttle control assembly.

(2) *Installation.*

- (a) Slide the throttle rod pivot onto the throttle control wire.
- (b) Push the rod (B) end through the throttle valve lever (U) hole, install a No. 8 flat washer over the rod end, a  $\frac{1}{16} \times \frac{1}{2}$  cotter pin through the rod hole, and spread the pin ends.
- (c) Push the rod (B) opposite end through the accelerator upper bellcrank assembly (D) hole, install a No. 8 flat washer over the rod end, a  $\frac{1}{16} \times \frac{1}{2}$  cotter pin through the rod hole and spread the pin ends.
- (d) Install the throttle control wire stop with screw (*h(3)(d)* below).

h. *Throttle Control Assembly.*

- (1) *Adjustment.* Loosen the set screw (N, fig. 64) in the throttle control wire stop with screw assembly (M, fig. 64). Push the throttle control (H, fig. 11) handle all the way into the dash. Slide the stop (M, fig. 64) up to the throttle rod (L, fig. 64) pivot; then slide the stop away from the pivot slightly and tighten the screw in the stop.

(2) *Removal.*

- (a) Loosen the set screw (N, fig. 64) and slide the throttle control wire stop with screw assembly (M, fig. 64) off the throttle control wire (S, fig. 64).
- (b) Loosen the screw in the throttle control conduit clamp (V) from the nut.
- (c) Unscrew the lockwasher nut from the throttle control assembly on the reverse side of the instrument panel.
- (d) Pull the throttle control assembly out of the pivot of the throttle rod, the conduit clamp, and the grommet in the dash, and out of the lockwasher nut and instrument panel.

(3) *Installation.*

- (a) Push the throttle control assembly end through the instrument panel hole part way and slide the  $\frac{3}{8}$ -inch lockwasher nut over the control end.
- (b) Push the control end through the grommet, in the dash, the throttle control conduit clamp (V) and the throttle rod (B) pivot.
- (c) Install the  $\frac{3}{8}$ -inch lockwasher nut onto the throttle control assembly at the reverse side of the instrument panel. Push the control handle all the way into the instrument panel. Leave a little slack in the control between the grommet in the dash and the throttle control conduit clamp and tighten the screw in the clamp.
- (d) Make sure the control handle is pushed all the way into the dash. Slide the throttle control wire stop with screw assembly (M, fig. 64) over the wire (S, fig. 64) end and up to the throttle rod (L, fig. 64) pivot. Slide the stop away from the pivot slightly and tighten the screw in the stop.

*i. Choke Control Assembly.*

- (1) *Adjustment.* Loosen the set screw (V, fig. 64) in the choke valve lever pivot (U, fig. 64). Push the choke control (EE, fig. 11) handle all the way into the instrument panel. Push the choke valve lever (T, fig. 64) towards the front of the vehicle as far as it will go. Tighten the set screw (V, fig. 64) in the choke valve lever pivot (U, fig. 64).

(2) *Removal.*

- (a) Loosen the set screw (V, fig. 64) in the choke valve lever pivot (U, fig. 64). Loosen the bolt (R, fig. 64) from the nut in the choke control conduit clamp (Q, fig. 64).
- (b) Unscrew the lockwasher nut from the choke control assembly on the reverse side of the instrument panel.
- (c) Pull the choke assembly out of the pivot, the conduit clamp, the grommet in the dash, the lockwasher nut, and instrument panel.

(3) *Installation.*

- (a) Push the choke control assembly end through the hole in the instrument panel part way, and slide the  $\frac{3}{8}$ -inch lockwasher nut over the control end.
- (b) Push the control end through the grommet in the dash, the choke control conduit clamp (Q, fig. 64), and the choke valve lever pivot (U, fig. 64).
- (c) Screw the  $\frac{3}{8}$ -inch lockwasher nut onto the choke control assembly at the reverse side of the instrument panel and tighten the nut. Push the control handle all the way into the instrument panel. Leave a little slack in the control between the grommet in the dash and the choke control conduit clamp and tighten the screw in the clamp.
- (d) Adjust the choke control ((1) above).

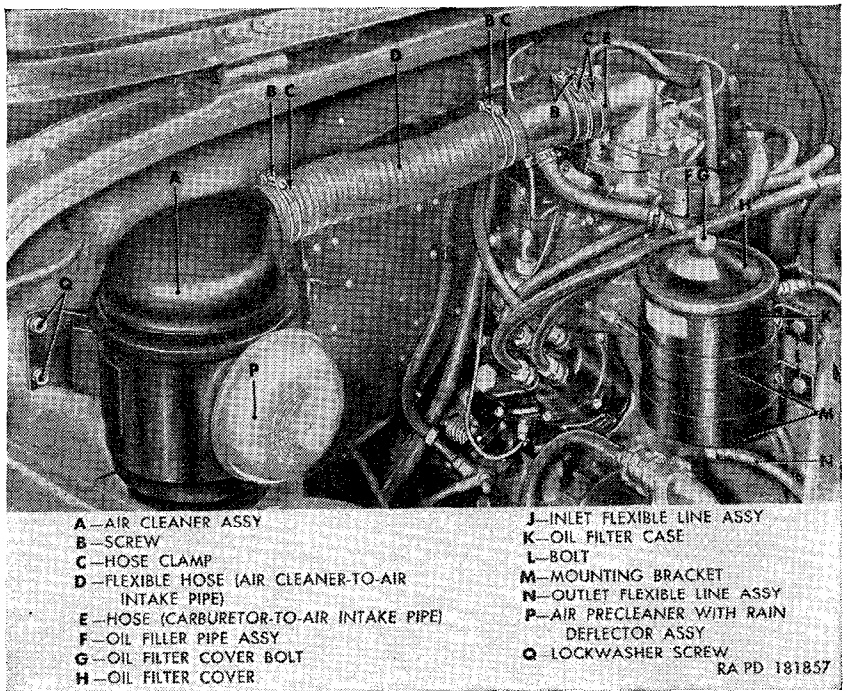

Figure 66. Air cleaner and oil filter assemblies—installed.

### 136. Air Cleaner Assembly

(fig. 66)

*a. Removal.*

- (1) Loosen the screw (B) in the hose clamp (C) at the air cleaner assembly (A) and slide the flexible hose (D) off the cleaner.
- (2) Unscrew the four lockwasher screws (Q) from the air cleaner assembly (A) bracket and remove the air cleaner from the vehicle.



- (3) Loosen the screw in the clamp on the air precleaner with rain deflector assembly (P) and pull the air precleaner and clamp from the air cleaner.

*b. Installation.*

- (1) Place the  $3\frac{1}{8}$ -inch clamp on the neck of the air precleaner with rain deflector assembly (P), install air precleaner on air cleaner assembly (A), and tighten the clamp screw.
- (2) Push the air cleaner into the flexible hose (D) and position the air cleaner on the dash. Put the four  $\frac{5}{16} \times \frac{5}{8}$  lockwasher screws (Q) through the air cleaner bracket holes and screw them into the dash and tighten. Tighten the screw (B) in the hose clamp (C) on the flexible hose (D) at the air cleaner.

### 137. Fuel and Vacuum Pump Assembly

*Note.* The key letters noted in parentheses refer to figure 67, except where otherwise indicated.

*a. Removal.*

- (1) Close the fuel shutoff valve (Q, fig. 55).
- (2) Unscrew the nut (B) on the fuel line (A) end from the elbow (C) in the fuel and vacuum pump (M). Unscrew the nut (Q) on the fuel line (P) end from the flexible fuel line (R). Unscrew the nut (K) on the vacuum pump-to-tee line (J) end from the elbow (L) in the pump. Unscrew the nut (G) on the vent line (F) end from the elbow (H) in the pump.
- (3) Unscrew the screw (N) and the bolt (E) in the pump and remove the pump, spacer, and gaskets from the vehicle.
- (4) Unscrew the three elbows (C, H, and L) from the pump. Unscrew the elbow (S) with the flexible fuel line (R) from the pump if pump is being replaced.

*b. Installation.*

- (1) If pump is being replaced, install the three elbows (C, H, and L) and the flexible fuel line (R) with the elbow (S) in the pump.
- (2) Place a  $\frac{5}{16}$ -inch lockwasher on the screw (N) and bolt (E). Push the screw and bolt with the lockwasher through the pump holes.
- (3) Place a fuel pump-to-cylinder block gasket, fuel pump-to-cylinder block spacer, and a gasket over the end of the screw and bolt in the above named order.
- (4) Position the fuel and vacuum pump (M) with gaskets and spacer on the cylinder block (D) and install the bolt (E) and screw (N) into the block, tightening evenly.

- (5) Screw the nut on the fuel line (A) into the elbow (C). Screw the nut on the vacuum pump-to-tee line (J) end into the elbow (L). Screw the nut on the vent line (F) end into the elbow (H). Screw the nut on the fuel line (P) end into the flexible fuel line (R).
- (6) Turn the fuel shutoff valve (Q, fig. 55) on. Start the engine and check for proper pump operation or leaks.

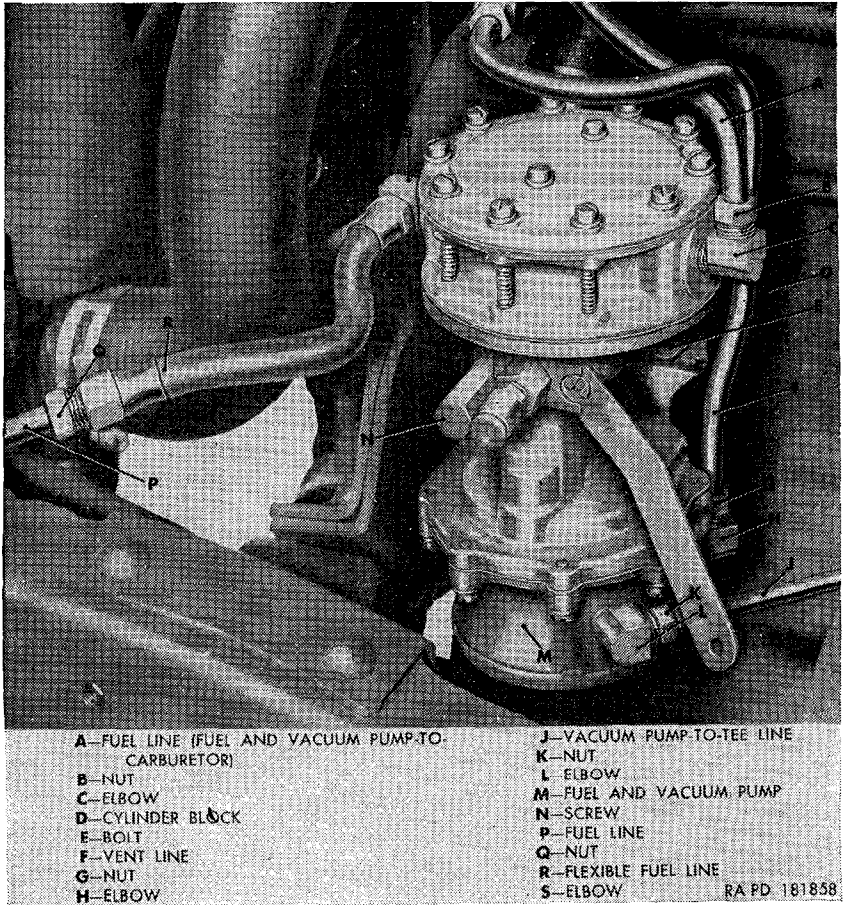

Figure 67. Fuel and vacuum pump assembly—installed.

## 138. Fuel Filter Assembly

(fig. 69)

### a. Removal.

- (1) Remove the driver's seat (pars. 261a(1) for the M38A1 and 272a(1) for the M170).
- (2) Unscrew the nut (M) on the fuel line (C) from the fuel filter assembly (H).

- (3) Unscrew the 12 screws (L) from the fuel filter assembly and remove the screws and soft copper seal washers. Lift the filter out of the fuel tank and remove and discard the neoprene gasket (J) from the top of the tank.

*b. Installation.*

- (1) Place a new neoprene gasket (J) around the opening in the fuel tank for the fuel filter assembly (H). Install the filter in the tank. Aline the holes in the gasket and the filter with the holes in the tank. Place a soft copper sealing washer over each of the 12 No. 8 x  $\frac{7}{16}$  screws (L). Install the screws through the filter and the gasket, screw into the tank, and tighten evenly.
- (2) Install the fuel line (C) in the fuel filter assembly and screw the nut (M) on the line end into the filter.
- (3) Install the driver's seat (pars. 261a(2) for the M38A1 and 272a(2) for the M170).

### 139. Fuel Filter Element

(fig. 68)

*a. Removal.*

- (1) Remove the fuel filter assembly (par. 138a).
- (2) Unscrew the nut on the line of the upper end plate with line from the cover plate with vent assembly.
- (3) Loosen the screw from the nut in the cover plate with vent assembly bracket sufficiently to allow the fuel filter element to slide through the bracket, and remove the element.

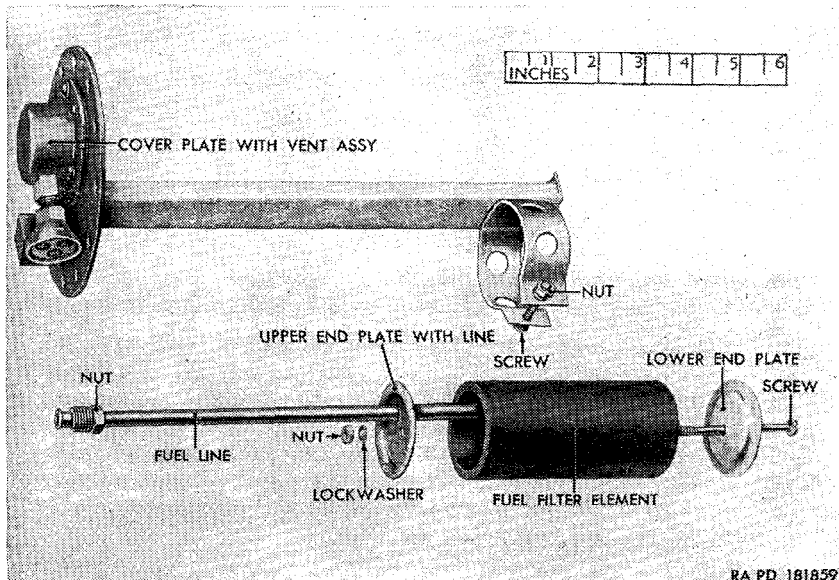

Figure 68. Fuel filter element—exploded view.

- (4) Unscrew the nut from the screw in the element and remove the lockwasher. Pull the screw out of the upper end plate and out of the element. Remove the lower end plate from the bottom of the element.
- b. Installation.*
- (1) Slide the lower end plate over the No. 10 x 6 screw. Slide the fuel filter element over the screw and position the element on the end plate. Slide the upper end plate with fuel line over the screw and position the plate on the element. Place a No. 10 lockwasher over the screw and a No. 10 nut onto the screw and tighten.
  - (2) Slide the fuel filter element into the cover plate with vent assembly bracket. Screw the nut on the line of the upper end plate with line into the cover plate. Tighten the screw into the cover plate with vent assembly bracket nut.
  - (3) Install the fuel filter assembly (par. 138*b*).

#### **140. Fuel Tank (M38A1)**

(fig. 69)

*a. Removal.*

- (1) Remove the drain plug from the bottom of the fuel tank (B) and drain the fuel into a suitable container.
- (2) Remove the driver's seat (par. 261*a*(1)).
- (3) Remove the fuel level sending unit assembly (T) (par. 189*a*) and remove the sending unit cable 28 (N) from the clips (G).
- (4) Remove the fuel filter assembly (par. 138*a*).
- (5) Remove the fuel line (C) (par. 142*e*(1)).
- (6) Remove the filler cap with chain assembly (E) by turning the cap counterclockwise and unhook the chain from the inside of the fuel tank filler neck (D).
- (7) Remove the lockwasher screw (K) at the front and at the rear of the tank from the mounting strap (Q) and remove the strap and antisqueak (P).
- (8) Slide the tank to the right of the vehicle until the filler neck (D) has cleared the grommet (F) in the filler neck opening in the side of the body, and remove the tank.

*b. Installation.*

- (1) Position the fuel tank in the vehicle and carefully slide the filler neck (D) through the grommet (F) in the opening in the side of the body.
- (2) Position the antisqueak (P) over the top of the tank, install the mounting strap (Q) over the antisqueak, install a  $\frac{5}{16}$  x  $\frac{7}{8}$



## 141. Fuel Tank (M170)

(fig. 70)

### a. Removal.

- (1) Remove the drain plug from the bottom of the tank and drain fuel into a suitable container.
- (2) Tilt driver's seat forward and remove (par. 272a(1)).
- (3) Unscrew the seven lockwasher screws securing the fuel tank unit access plate to the vehicle floor.
- (4) Unscrew the fuel line nut.
- (5) Disconnect the cable bayonet connector from the fuel level sending unit.

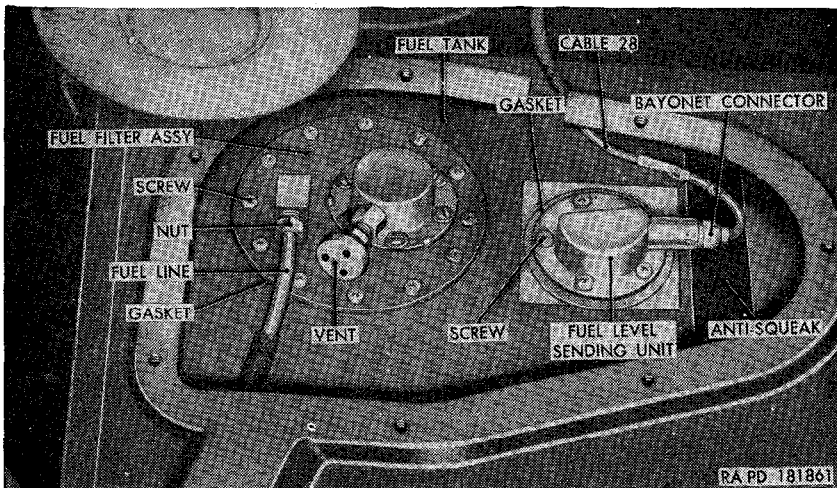

Figure 70. Fuel tank, fuel filter, and fuel level sending unit assemblies (M170)—installed—driver's seat and fuel tank unit access plate removed.

- (6) Place a stand or blocking under the tank, making certain that such stand or blocking clears the fuel tank support strap (fig. 71).
- (7) Remove the four nuts and flat washers from the studs on the fuel tank support strap attaching brackets at each end of the fuel tank, and remove the two fuel tank shields and support straps.
- (8) Remove stands or blocking and lower tank.
- (9) Remove the filler cap with chain assembly by turning the cap counterclockwise and unhook the chain from the inside of the fuel tank filler neck.
- (10) Remove the 12 screws and soft copper seal washers securing fuel filter assembly to the tank, and remove the filter assembly and gasket.

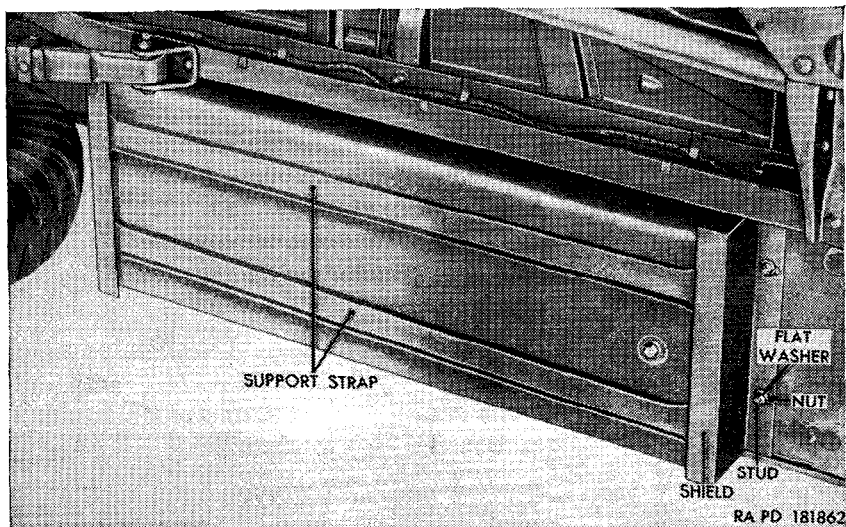

Figure 71. Fuel tank (M170)—installed.

- (11) Remove the five screws and soft copper seal washers securing the fuel level sending unit to the tank, and remove the sending unit and gasket.

*b. Installation.*

- (1) Position fuel level sending unit and gasket on top of the fuel tank and secure with No. 8 x  $\frac{1}{2}$  screws and soft copper seal washers.
- (2) Position fuel filter assembly and gasket on top of the fuel tank and secure with twelve No. 8 x  $\frac{7}{16}$  screws and soft copper seal washers.
- (3) Install new antisqueak strips to top of tank with adequate adhesive.
- (4) Raise tank between the fuel tank support strap attaching brackets and position stands or blocking under the tank, making certain such stand or blocking will clear fuel tank support straps.

**Caution:** Make sure fuel line and fuel level sending cable are accessible through fuel tank unit access plate opening and are free from binding.

- (5) Aline the ends of the two fuel tank support straps and one tank shield on the fuel tank support bracket studs at one end of the tank. Start but do not tighten the two  $\frac{3}{8}$ -inch nuts with washers on the two tank support bracket studs. Repeat the procedure for the other end of the tank. Tighten the four tank support bracket stud nuts.
- (6) Remove the stands or blocking.
- (7) Install the drain plug in the bottom of the tank.

- (8) Connect the bayonet connector to the fuel level sending unit.
- (9) Install the fuel line nut to the fuel filter assembly.
- (10) Fill the fuel tank. Install the filler cap with chain assembly, by hooking the chain into the loop inside of the filler neck, install filler cap on the filler neck, and turn in a clockwise direction to lock the cap on the tank.
- (11) Start the engine and make sure there are no leaks at the fuel line connections. Check the fuel level gage for proper sending unit operation.
- (12) Position the fuel tank unit access plate over the opening in the floor and secure with seven  $\frac{1}{4}$  x  $\frac{1}{2}$  lockwasher screws.
- (13) Install driver's seat by tilting the seat forward until seat frame slips into seat brackets on the vehicle floor (par. 272a (2)).

## 142. Fuel Lines and Fittings

(fig. 72)

### a. Flexible Fuel Line.

- (1) *Removal.* Unscrew the nut on the fuel line (Q) from the flexible fuel line (M). Unscrew the flexible fuel line (M) from the connector on the fuel and vacuum pump assembly (L).
- (2) *Installation.* Screw the flexible fuel line (M) into the connector on the fuel and vacuum pump assembly (L). Screw the nut on the fuel line (Q) into the flexible fuel line (M).

### b. Fuel Shutoff Valve-to-Flexible Fuel Line.

- (1) *Removal.* Unscrew the nut at each end of the fuel line (Q) and remove the line from the vehicle.
- (2) *Installation.* Position the fuel line (Q) between the shutoff valve (P) and the flexible fuel line (M) and screw the nut on each end of the line into the flexible fuel line and the fuel shutoff valve.

### c. Tee-to-Shutoff Valve Fuel Line.

- (1) *Removal.* Unscrew the nut on each end of the fuel line (N). Remove the line from the clips (D), and remove from the vehicle.
- (2) *Installation.* Position the fuel line (N) between the tee (A) and the fuel shutoff valve (P) and screw the nut on each end of the line into the tee and the shutoff valve. Secure the line in the clips (D).

### d. Rear Fuel Line (Elbow-to-Tee).

- (1) *Removal.* Unscrew the nut at each end of the fuel line (E). Remove the line from the clips (D) and remove from the vehicle.



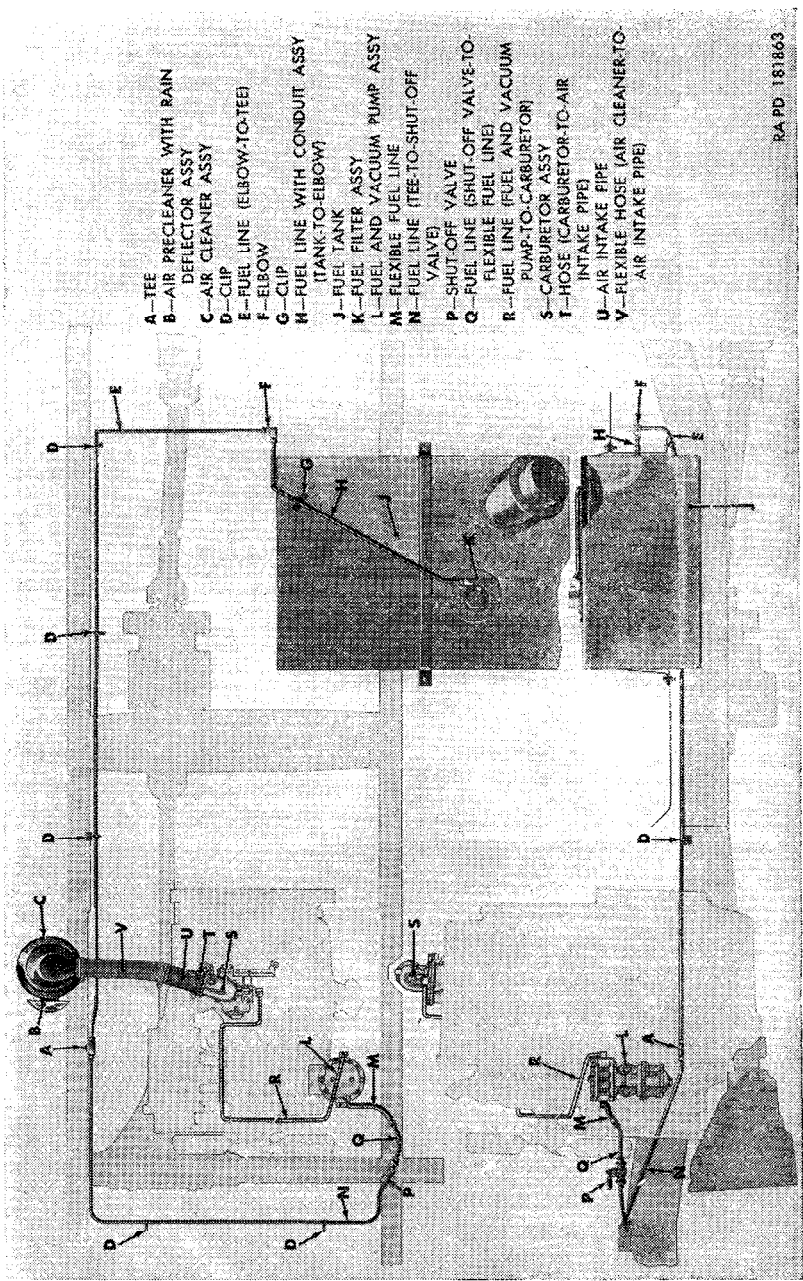

PA PD 181863

Figure 72. Fuel and air intake system.

- (2) *Installation.* Position the fuel line (E) between the tee (A) and the elbow (F) and screw the nut on each end of the line into the tee and the elbow. Secure the line in the clips (D).
- e. *Tank-to-Elbow Fuel Line With Conduit Assembly.*
- (1) *Removal.*
- (a) Remove the driver's seat (pars. 261a(1) for the M38A1 and 272a(1) for the M170).
- (b) Unscrew the nut on each end of the fuel line (H). Remove the line from the clip (G), and remove the line from the vehicle.
- (2) *Installation.*
- (a) Position the fuel line (H) between the fuel filter assembly (K) and the elbow (F) and in the clip (G). Screw the nut on each end of the line into the elbow (F) and the fuel filter assembly (K).
- (b) Install the driver's seat (pars. 261a(2) for the M38A1 and 272a(2) for the M170).
- f. *Fuel and Vacuum Pump-to-Carburetor Line Assembly.*
- (1) *Removal.* Unscrew the nut on each end of the fuel line (R) and remove the line from the vehicle.
- (2) *Installation.* Position the fuel line (R) between the fuel and vacuum pump assembly (L) and the carburetor assembly (S) and screw the nut on each line end into the carburetor and the fuel and vacuum pump elbows.
- g. *Tee.*
- (1) *Removal.* Unscrew the nuts on fuel line (N and E) from the tee (A), and remove the tee from the vehicle.
- (2) *Installation.* Position the tee (A) between fuel line (N and E). Screw the nuts on the end of the lines (N and E) into the tee.
- h. *Fuel Shutoff Valve.*
- (1) *Removal.* Unscrew the nut on fuel lines (N and Q) from the fuel shutoff valve (P) and remove the valve from the vehicle.
- (2) *Installation.* Position the fuel shutoff valve (P) between the fuel lines (N and Q) and screw the nut on the end of the lines into the valve.
- i. *Elbow (Rear Fuel Line-to-Elbow and Tank-to-Elbow Line).*
- (1) *Removal.* Unscrew the nut on the fuel line (H and E) from the elbow (F), and remove the elbow from the vehicle.
- (2) *Installation.* Position the elbow (F) between the fuel line (E and H) and screw the nut on the end of the lines into the elbow.

## Section IX. EXHAUST SYSTEM

### 143. Description

The exhaust system (fig. 73) includes the exhaust muffler, the exhaust pipe extension, and the exhaust pipe. The system is supported at three points—the exhaust pipe is secured to the exhaust manifold of the engine; the exhaust pipe extension is secured to the frame by a bracket and spacer; and the muffler is secured to the frame by a muffler support clamp bracket around the tail pipe of the muffler assembly.

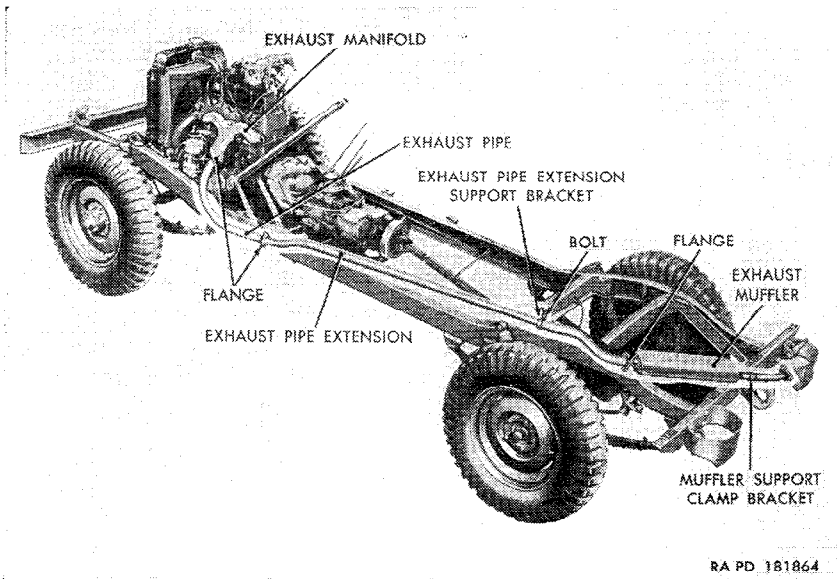

Figure 73. Exhaust system.

### 144. Exhaust System

(fig. 74)

#### a. Removal.

- (1) Remove the three safety nuts and bolts securing the muffler flange to the exhaust pipe extension rear flange.
- (2) Remove the nut and bolt securing the muffler support clamp bracket to the frame rear cross member.
- (3) Remove the exhaust muffler with bracket assembly. Separate and discard the gasket from the flange.

#### b. Installation.

- (1) Insert three  $\frac{5}{16}$  x 1 bolts through the front flange of the exhaust muffler with bracket assembly, and place a new gasket over the bolts. Raise the muffler into position and insert the

bolts through the exhaust pipe extension rear flange holes. Start but do not tighten three  $\frac{5}{16}$ -inch safety nuts onto the bolts.

- (2) Insert a  $\frac{5}{16} \times 1\frac{1}{4}$  bolt through the hole in the muffler support clamp bracket and the frame cross member. Place a  $\frac{5}{16}$ -inch nut on the bolt end and tighten the bolt.
- (3) Tighten the three safety nuts on the bolts securing the muffler to the exhaust pipe extension.
- (4) Start the engine and check all exhaust connections for leaks.

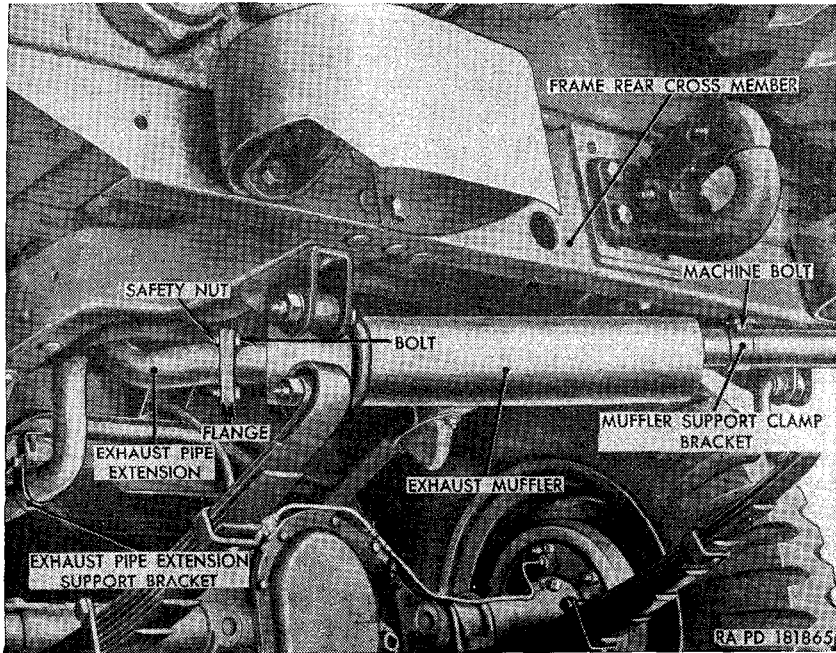

Figure 74. Exhaust muffler with bracket assembly—installed.

## 145. Exhaust Pipe Extension With Bracket Assembly

### a. Removal.

- (1) Remove the three nuts and bolts securing the exhaust pipe extension to the exhaust pipe (fig. 73).
- (2) Remove the three nuts and bolts securing the exhaust pipe extension to the exhaust muffler (fig. 74).
- (3) Loosen the bolt securing the muffler support clamp bracket to the frame rear cross member and slide the muffler back about one inch.
- (4) While supporting the exhaust pipe extension, remove the nut, washer, spacer, and bolt securing the exhaust pipe extension support bracket to the frame cross member.

- (5) Separate the front flange of the exhaust pipe extension from the rear flange of the exhaust pipe, and remove exhaust pipe extension with bracket. Separate and discard gasket from both flanges.

*b. Installation.*

- (1) Clean the flange gasket surfaces. Loosen the nut and bolt in the clamp at the exhaust pipe extension support bracket (fig. 74). Place the exhaust pipe extension in approximate position under the vehicle with the offset end toward the exhaust muffler (fig. 73).
- (2) Insert a  $\frac{5}{16} \times 1\frac{1}{2}$  machine bolt through the bracket (fig. 74) hole and slip the exhaust pipe extension spacer over the bolt. Raise the exhaust pipe extension with bracket into position with the bolt end inserted into the frame cross member hole. Place a  $1\frac{1}{32}$  ID  $\times$   $1\frac{1}{16}$  OD washer over the bolt and screw a  $2\frac{5}{16}$ -inch nut on the threads enough to support the exhaust pipe extension weight.
- (3) Place a new gasket on the front flange of the exhaust pipe extension (fig. 73) and insert three  $\frac{5}{16} \times 1$  bolts through the exhaust pipe flange, gasket, and exhaust pipe extension flange. Start three  $\frac{5}{16}$ -inch nuts on the three bolts, but do not tighten.
- (4) Place a new gasket on the flange of the exhaust muffler (fig. 74). Pull the muffler forward and insert three  $\frac{5}{16} \times 1$  bolts through the muffler flange, gaskets, and rear flange of the exhaust pipe extension. Start three  $\frac{5}{16}$ -inch nuts on the bolts, but do not tighten.
- (5) Tighten the bolts and nuts securing the exhaust pipe extension to the exhaust pipe. Tighten the bolts and nuts securing the exhaust pipe extension to the exhaust muffler (fig. 73). Tighten the bolt securing the exhaust pipe extension support bracket to the frame cross member. Tighten the bolt and nut in the support bracket clamp. Tighten the bolt securing the muffler support clamp bracket (fig. 74) to the frame rear cross member.
- (6) Start engine and check all exhaust connections for leaks.

## **146. Exhaust Pipe**

(fig. 73)

*a. Removal.*

- (1) Remove the nut from the stud in the exhaust manifold flange. Remove the nut and bolt securing the exhaust pipe front flange to the exhaust manifold.

- (2) Separate the flanges. Remove the three nuts and bolts securing the exhaust pipe rear flange to the exhaust pipe extension front flange. Separate the flanges. Remove and discard gaskets.
- (3) Drop the exhaust pipe down and remove.

*b. Installation.*

- (1) Clean the gasket surfaces of the exhaust pipe flanges. Place a new gasket on the front flange and position the flange over the  $\frac{3}{8}$ -inch stud in the exhaust manifold. Start a  $\frac{3}{8}$ -inch nut on the stud, but do not tighten. Insert a  $\frac{3}{8} \times 1\frac{1}{2}$  bolt through the manifold mounting hole and the flange hole. Start but do not tighten a  $\frac{3}{8}$ -inch nut on the bolt.
- (2) Place a new gasket on the exhaust pipe rear flange and position the flange against the exhaust pipe extension front flange, aligning the holes in the two flanges. Insert three  $\frac{5}{16} \times 1$  bolts through the holes in the flanges and gasket, and start but do not tighten three  $\frac{5}{16}$ -inch nuts on the bolts.
- (3) Tighten the nuts on the stud and bolt securing the exhaust pipe to the exhaust manifold.
- (4) Tighten the three nuts and bolts securing the exhaust pipe to the exhaust pipe extension.
- (5) Start the engine and check all exhaust connections for leaks.

## Section X. IGNITION SYSTEM

### 147. Description and Data

*a. Description.* The ignition system consists of the batteries, ignition switch, distributor with coil assembly, spark plugs, and circuit cables. The batteries are discussed in paragraph 162 and the ignition switch in paragraph 181. The distributor with coil assembly consists of the distributor, two capacitors, and ignition coil, in a single unit mounted on the right side of the engine block and driven from the oil pump. The primary, or low voltage circuit includes the batteries, ignition switch, breaker points, primary capacitor, breaker point capacitor, and the primary windings of the ignition coil. The secondary, or high voltage circuit, consists of the secondary winding of the coil, distributor rotor, distributor cover, cap assembly, spark plug cable assemblies, and spark plugs. The entire ignition system is waterproofed and includes devices for suppressing radio interference as described in paragraph 280. Ignition system components and cables are identified in figures 75 and 76.

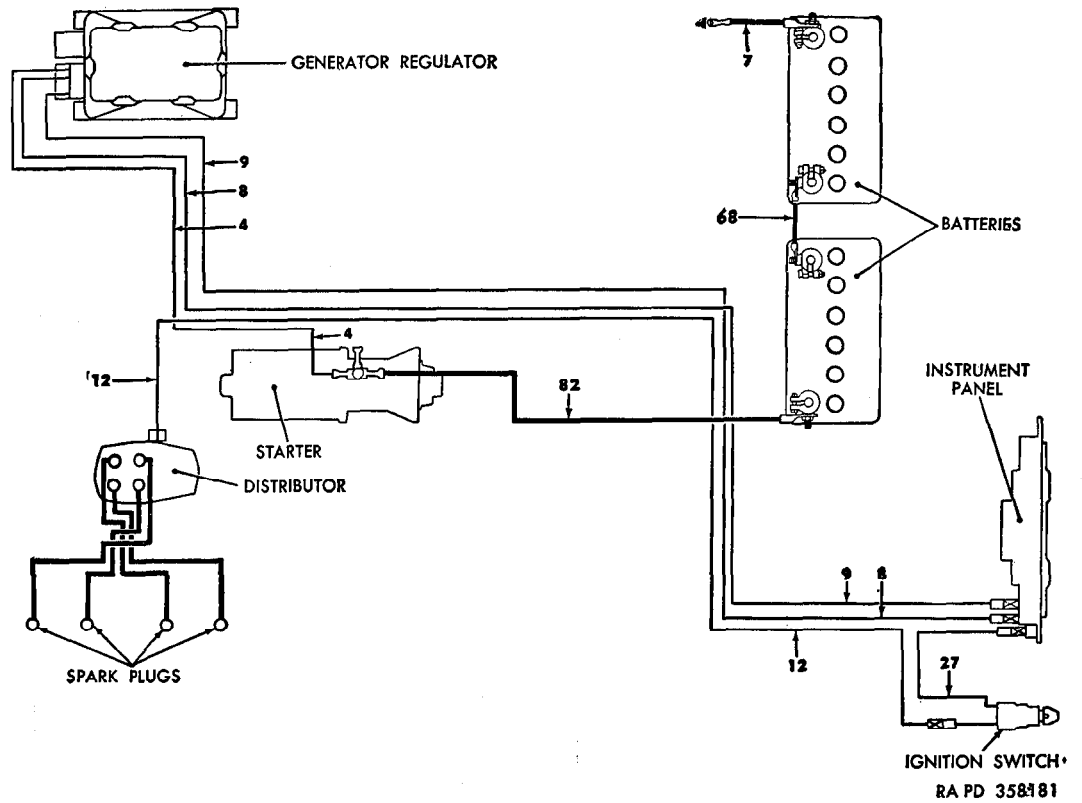
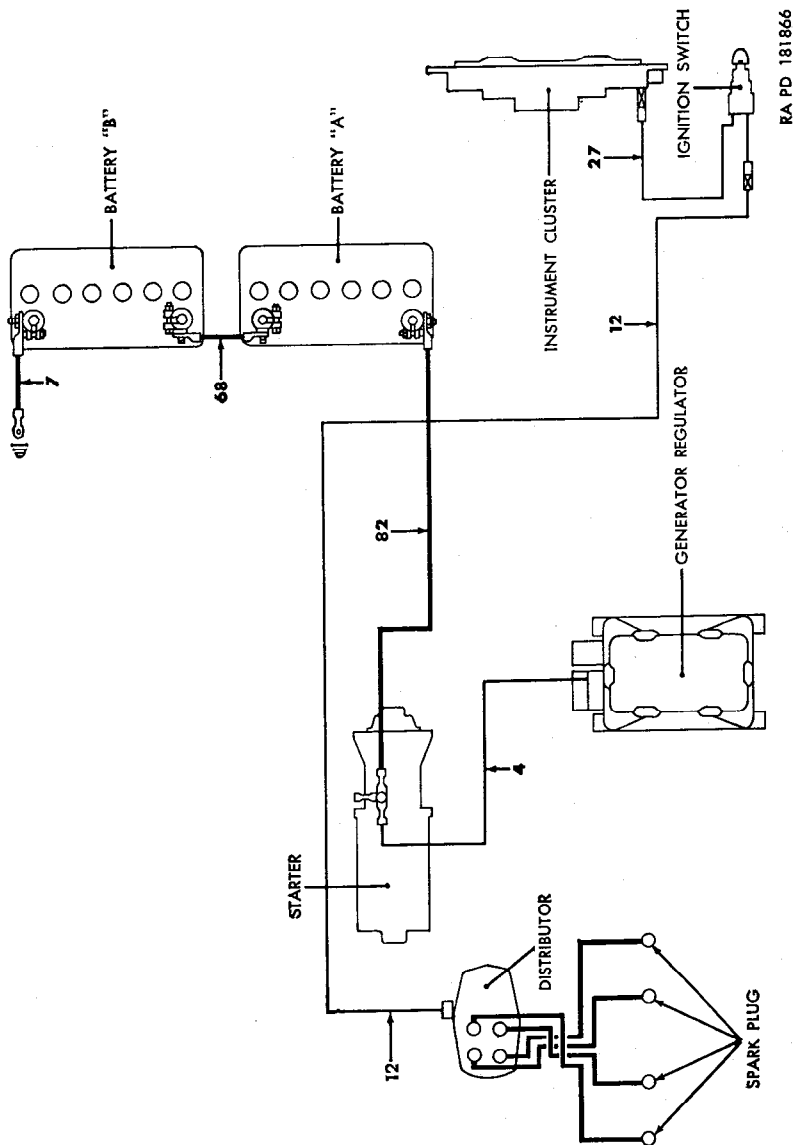

Figure 75. Ignition system components and cables identification (M38A1).



RA PD 181866

Figure 76. Ignition system components and cables identification (MI70).



## b. Data.

### Distributor with coil assembly:

Manufacturer	Electric Auto-Lite
Rotation	counterclockwise
Type of advance	centrifugal
Breaker point opening	0.020 in.
Breaker arm spring tension	17 to 20 oz
Firing order	1-3-4-2
Voltage	24
Cam angle	22° 38° per revision

### Ignition coil:

Manufacturer	Electric Auto-Lite
Model	CT 4002
Voltage	24

### Spark plugs:

Ordnance number	8357724
Thread size	14-mm
Gap	0.030 in.

## 148. Organizational Maintenance

Periodic inspection and lubrication of the ignition system is the responsibility of the using organization. See lubrication chart (figs. 29 and 30) for detailed instructions. Information and data for ignition system maintenance is given in paragraphs 149 through 153. Operations not described are the responsibility of ordnance maintenance units. However, in an emergency, using organizations may perform ordnance maintenance unit operations, provided permission is obtained from the ordnance maintenance unit.

## 149. Ignition Timing

Ignition timing is accomplished by three separate and consecutive procedures; breaker point set adjustment; approximate timing by distributor position adjustment; and precise timing, with the engine running, by installation of a special adapter and timing light.

a. Mark the position of the No. 1 spark plug cable assembly (fig. 79) on the side of the distributor with coil assembly, to aid in positioning the distributor rotor during approximate timing. Adjust the breaker point set (par. 151b(1)) but do not install the cover and cap assembly.

b. Loosen the mounting screw securing the distributor with coil assembly to the spark advance control arm (fig. 79). With the distributor rotor (fig. 81) pointed toward the mark showing position of No. 1 spark plug cable assembly (a above), turn the distributor counterclockwise until the breaker points are closed. Slowly turn the distributor clockwise until the points start to open. Tighten the mounting screw (fig. 79). Place the cover and cap assembly on the distributor and secure with six No. 10 x  $\frac{11}{16}$  fillister-head, internal-teeth lockwasher screws.

e. Unscrew the terminal nut securing the spark plug cable assembly to the No. 1 spark plug (fig. 40), and disconnect the cable. Push the timing light adapter (fig. 77) over the spark plug and connect the cable to the adapter. Connect one timing light terminal to the adapter and the other terminal to a convenient ground.

d. Start the engine and run at idling speed. Direct the timing light beam on the "5" timing mark on the timing gear cover (fig. 78). The timing mark should be alined with the crankshaft pulley (fig. 78) notch. If not, loosen the mounting screw (fig. 79) securing the distributor with coil assembly to the spark advance control arm. Turn the distributor until the timing mark and hole are alined. Tighten the mounting screw.

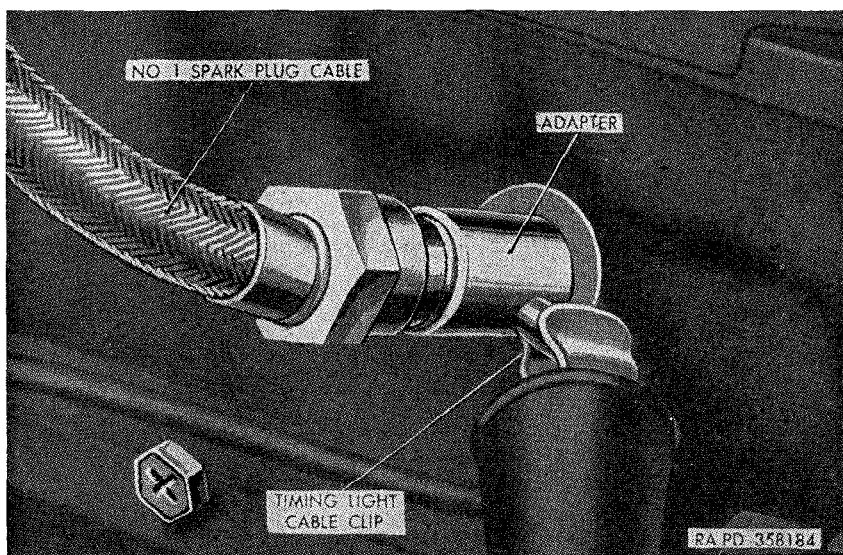

Figure 77. Timing light adapter—installed.

e. Stop the engine and remove the timing light. Pull the adapter from the spark plug and unscrew the terminal nut from the adapter. Connect the No. 1 spark plug cable assembly to the spark plug (fig. 40) by screwing the terminal nut onto the spark plug.

## 150. Distributor With Coil Assembly (fig. 79)

### a. Removal.

- (1) Mark the spark plug cable assemblies for identification at installation. Unscrew the four terminal nuts securing the spark plug cable assemblies to the distributor cover and disconnect the cables.

- (2) Unscrew the two nuts securing the two vent lines to the two connectors and pull the lines from the connectors.
- (3) Unscrew the nut securing the primary cable to the wiring harness receptacle and pull the cable from the receptacle.
- (4) Remove the lockwasher screw and flat washer securing the distributor to the spark advance control arm.

*Note.* This screw is installed through the control arm slot.

Lift the distributor with drive shaft from engine block.

- (5) Remove the spark advance control arm thrust washer from the shaft. Remove the two vent line connectors.

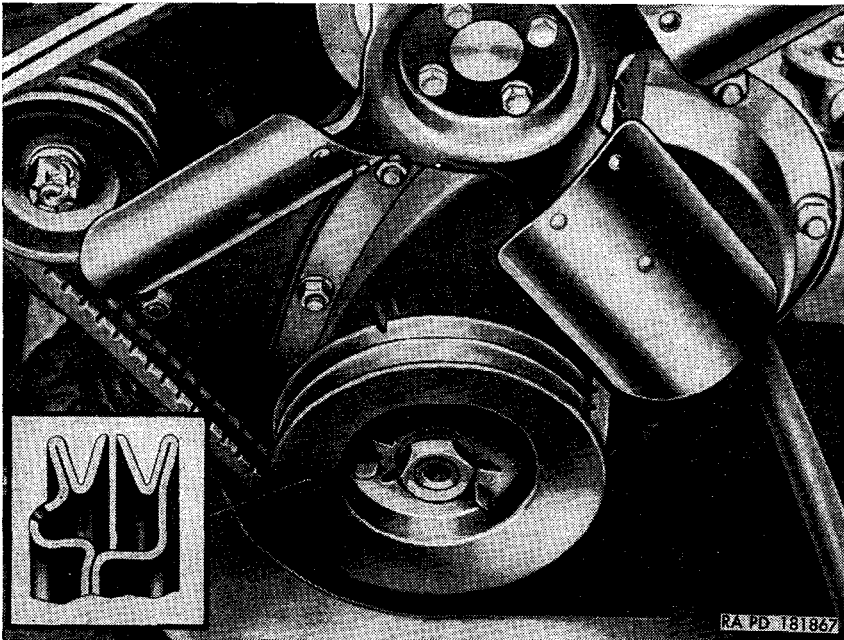

Figure 78. Timing marks.

#### *b. Installation.*

- (1) Install vent line connectors in mounting holes. Make certain that distributor drive shaft friction spring is in place on lower end of drive shaft. Slip the spark advance control arm thrust washer over the shaft and against the bottom of the distributor.
- (2) Insert the drive shaft into the engine cylinder block side bore and lower the distributor with coil assembly into position. If necessary, rotate the shaft until the distributor seats on the spark advance control arm.
- (3) Place a  $\frac{9}{32}$  ID x  $\frac{5}{8}$  OD flat washer on a  $\frac{1}{4}$  x  $\frac{5}{8}$  lockwasher screw and start the screw through the spark advance control

arm slot and into the bottom of the distributor. Do not tighten screw until after timing ignition (par. 149).

- (4) Insert the primary cable plug into the wiring harness receptacle. Install the nut on the receptacle threads.
- (5) Insert the two vent lines into the two connectors and secure by tightening the two nuts.
- (6) Connect the spark plug cable assemblies to the distributor cover by screwing the terminal nuts onto the cover. Be certain that cables are installed in correct firing order.
- (7) Set the ignition timing (par. 149).

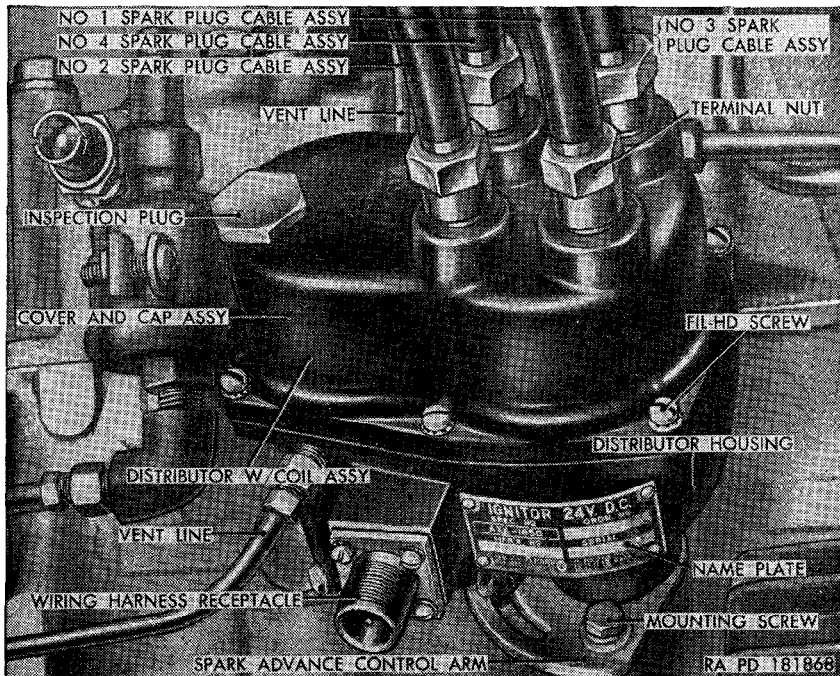

Figure 79. Distributor with coil assembly—installed—wiring harness removed.

## 151. Distributor

### a. Cover and Cap Assemblies.

- (1) *Removal.* Mark the spark plug cable assemblies (fig. 79) for identification. Unscrew the four terminal nuts securing the spark plug cable assemblies to the cover and cap assembly and disconnect the cable assemblies. Unscrew and remove the six fillister-head screws securing the cover to the distributor. Remove the cover and cap assemblies. Remove three bolts and lockwashers securing cap to cover (fig. 80). Remove cap.

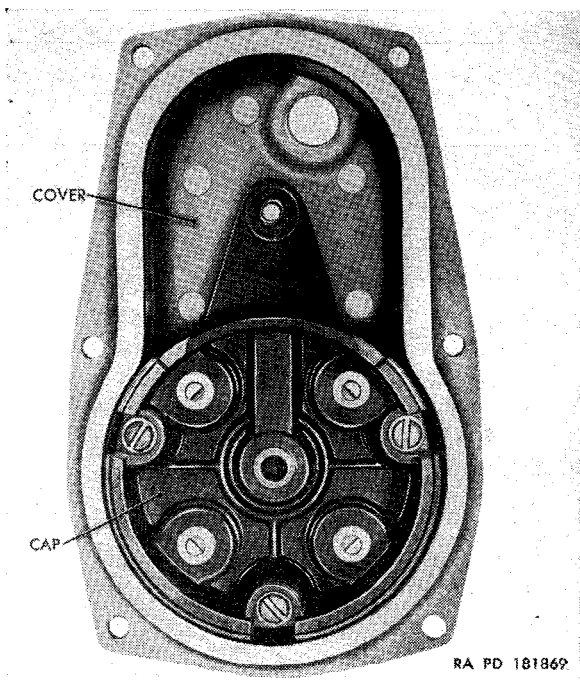

Figure 80. Distributor cap installed in cover.

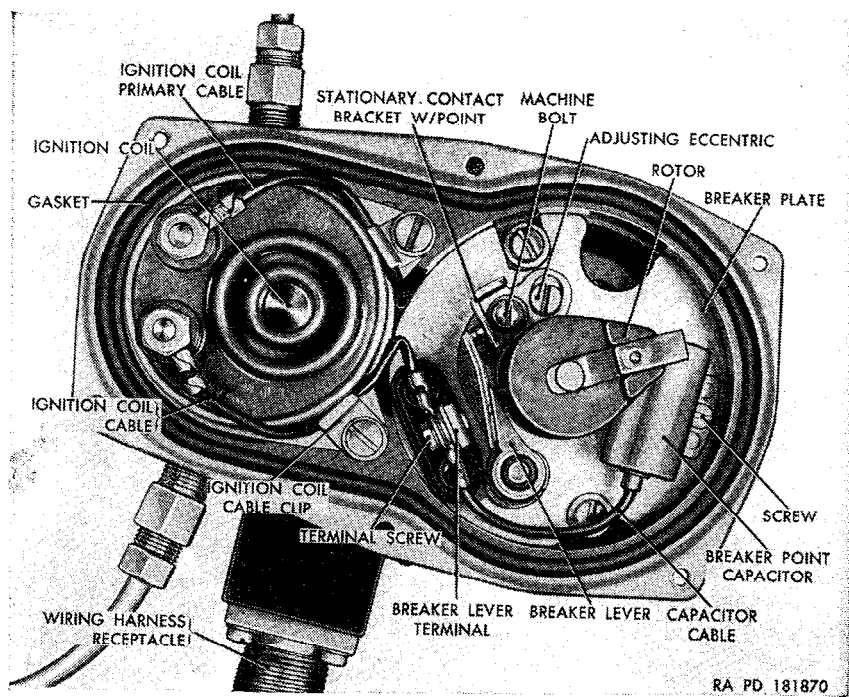

Figure 81. Distributor with coil assembly—cover and cap assemblies removed.

- (2) *Installation.* Position cap in cover (fig. 80) and secure with three No. 8 x 1 bolts and internal-teeth lockwashers. Position the cover and cap assembly on the top of the distributor (fig. 79). Insert six No. 10 x  $\frac{11}{16}$  fillister-head internal-teeth lockwasher screws into the six threaded holes in the top of the distributor and tighten the screws. Connect the spark plug cable assemblies to the cover by screwing the terminal nuts onto the cover. Be certain cables are installed in correct firing order.

*b. Breaker Point Set.*

(1) *Adjustment.*

- (a) Unscrew and remove the six fillister-head screws securing the cover to the distributor and remove the cover with the cap. Lift the rotor (fig. 81) off the cam.

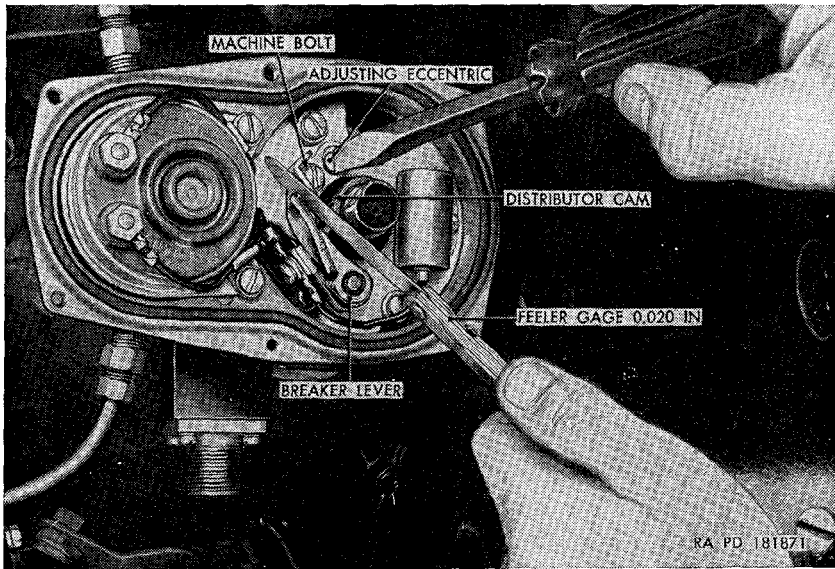

*Figure 82. Breaker point gap adjustment.*

- (b) Turn the crankshaft by pulling the top of the fan blade toward the right side of the vehicle, and pressing firmly on the drive belt. Continue turning until the breaker points are open, with the breaker lever on one of the four high points of the cam. Loosen the bolt securing the stationary contact bracket with point to the breaker plate.
- (c) Adjust the point gap by turning the adjusting eccentric (fig. 82) until the gap is 0.020 inch. Tighten the bolt and recheck the gap.
- (d) Place the breaker lever spring gage (fig. 83) end over the moveable breaker point and pull on the gage at right angle

to the breaker lever. The points should start to open with a pull of from 17 to 20 ounces. If necessary, adjust the tension by bending the breaker lever spring.

- (e) Place the rotor (fig. 81) on the cam. Position the cover with the cap (fig. 79) on the distributor and secure the cover to the distributor with six No. 10 x  $\frac{11}{16}$  fillister-head internal-teeth lockwasher screws.
- (2) *Removal* (fig. 81). Remove the cover and cap assemblies ((1) above). Loosen the terminal screw securing the breaker lever spring clip to the breaker lever terminal. Slide the breaker lever spring up and out of the clip and, at the

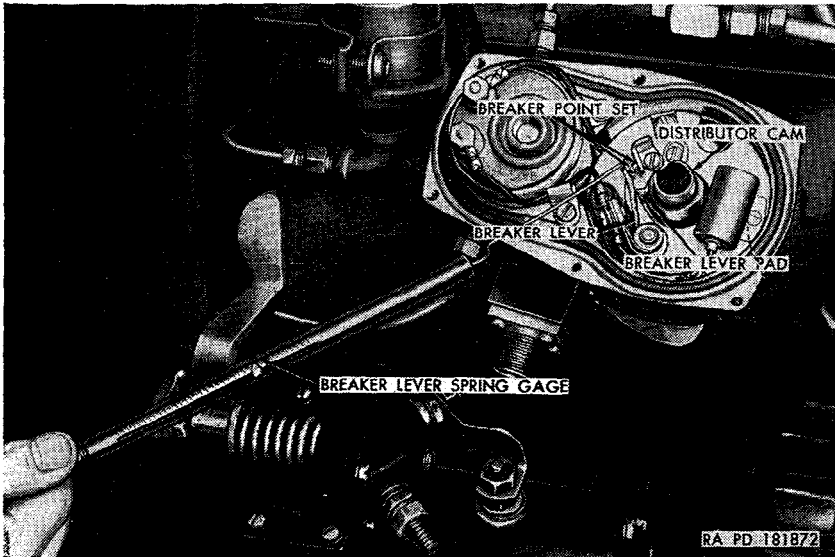

Figure 83. Breaker lever spring tension adjustment.

same time, lift the breaker lever up and off the pin. Remove the bolt and lockwasher securing the stationary contact bracket with point to the breaker plate, and remove the bracket.

- (3) *Installation* (fig. 81). Place the stationary contact bracket with point over the breaker plate pin, and over the adjusting eccentric. Slip a No. 8 internal-teeth lockwasher over a No. 8 x  $\frac{3}{16}$  bolt and start but do not tighten the bolt in the breaker plate threads. Place the breaker lever onto the breaker plate pin and position the breaker lever spring slot over the screw inside the breaker lever spring clip. Push the breaker lever onto the pin as far as it will go, making sure the lever spring is in the clip, and tighten the screw securing the

clip to the breaker lever terminal. Adjust the breaker point set gap ((1) (b) through (d) above).

(4) *Install rotor and cover.* Refer to (1) (e) above.

*c. Breaker Point Capacitor.*

(1) *Removal.*

(a) Unscrew and remove the six fillister-head screws securing the cover to the distributor, and remove the cover and cap assemblies (fig. 79). Lift the rotor (fig. 81) off the shaft cam end.

(b) Loosen the terminal screw securing the breaker lever spring clip to the breaker lever terminal, and pull the capacitor cable terminal from the screw. Remove the screw and lockwasher securing the capacitor to the breaker plate, and remove the capacitor.

(2) *Installation.* Position the breaker point capacitor (fig. 81) on the breaker plate and secure it with one No. 6 x  $\frac{3}{16}$  screw and  $\frac{3}{16}$ -inch internal-teeth lockwasher. Slip the capacitor cable terminal onto the screw securing the breaker lever spring clip to the breaker lever terminal and tighten the screw. Position the rotor on the cam and the cover and cap assembly (fig. 79) on the distributor and secure with six No. 10 x  $\frac{11}{16}$  fillister-head internal-teeth lockwasher screws.

*d. Primary Capacitor.*

(1) *Removal.* Unscrew and remove the six fillister-head screws securing the cover to the distributor housing, and remove the cover and cap assembly (fig. 79). Remove nuts, washers, and terminals of the ignition coil (fig. 81). Remove the two bolts, lockwashers, and clips securing the ignition coil. Remove the ignition coil. Remove the four lockwasher screws securing the wiring harness receptacle to the distributor housing. Unscrew the nut (X, fig. 54) securing the primary cable to the wiring harness receptacle and pull the cable from the receptacle. Pull the receptacle and primary capacitor from the distributor housing and separate the receptacle from the capacitor.

(2) *Installation.* Insert the primary capacitor control into the wiring harness receptacle (fig. 81) with the capacitor flange against the receptacle flange. Insert the terminal end of the ignition coil primary cable into the distributor housing; the other end is soldered to the primary capacitor. Pull the cable through sufficiently to place the cable terminal over the positive terminal of the ignition coil and secure with a No. 10 lockwasher and No. 10 nut. Secure the wiring harness receptacle to the distributor housing with four lockwasher screws. Place the ignition coil in the distributor housing.



Position and secure the ignition coil primary cable to the coil mounting bracket with clip, No. 10 lockwasher, and a No. 10 x  $\frac{7}{16}$  bolt. Secure the ignition coil to the housing with another No. 10 lockwasher and No. 10 x  $\frac{7}{16}$  bolt. Insert the primary cable plug into the wiring harness receptacle. Start the nut onto the receptacle threads and tighten. Position the cover and cap assembly (fig. 79) on the top of the distributor housing and secure with six No. 10 x  $1\frac{1}{16}$  fillister-head, internal-teeth lockwasher screws.

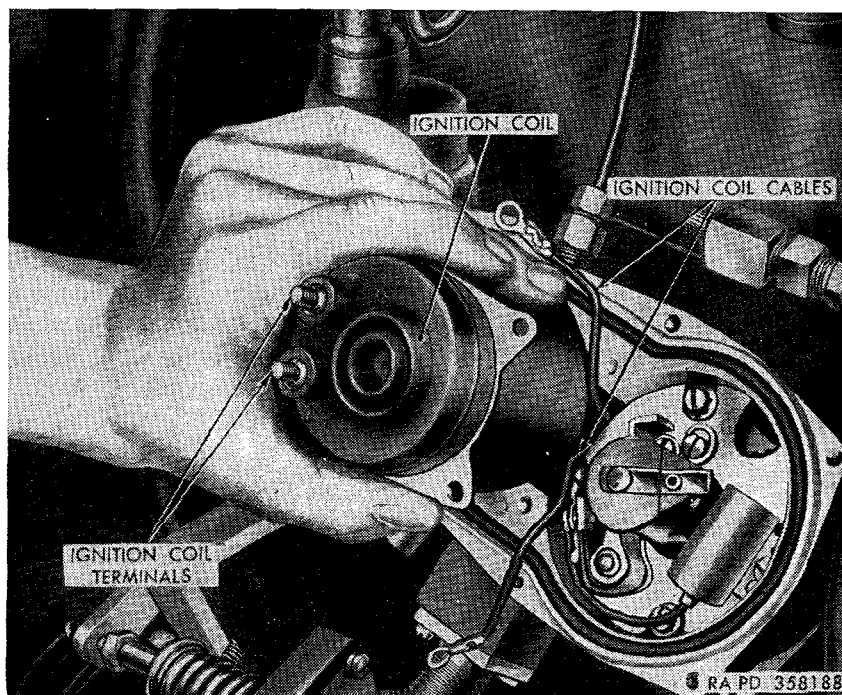

Figure 84. Ignition coil removal.

## 152. Ignition Coil

### a. Removal.

- (1) Unscrew and remove the six fillister-head screws securing the cover to the distributor housing, and remove the cover and cap assembly (fig. 79).
- (2) Remove the two nuts, washers, and cable terminals on the two ignition coil terminals studs. Remove the two bolts, lockwashers, and cable clips securing the ignition coil mounting bracket and cables to the distributor housing.
- (3) Lift ignition coil (fig. 84) with mounting bracket from the distributor with coil assembly.

*b. Installation.*

- (1) Place the ignition coil (fig. 89) in the distributor housing with the holes in the ignition coil mounting bracket alined with the holes in the distributor housing.
- (2) Position the two ignition coil cables and secure cables and mounting bracket to the housing with two ignition coil cable clips (fig. 81), No. 10 lockwashers, and No. 10 x  $\frac{7}{16}$  bolts. Place the two ignition coil cable terminals on the ignition coil terminals and secure with two No. 10 washers and No. 10 nuts.
- (3) Place the cover and cap assembly (fig. 79) on the top of the distributor housing and secure with six No. 10 x  $\frac{11}{16}$  fillister-head, internal-teeth lockwasher screws.

### **153. Spark Plug Cable Assemblies and Spark Plugs**

*a. Spark Plug Cable Assemblies Removal.*

- (1) Mark the spark plug cable assemblies (fig. 79) for identification. Unscrew the four terminal nuts securing the spark plug cable assemblies to the distributor cover and cap assembly and disconnect the cable assemblies.
- (2) Unscrew the four terminal nuts securing the spark plug cable assemblies (fig. 40) to the spark plugs. Disconnect and remove the cables from the plugs.

*b. Spark Plug Cable Assemblies Installation.*

- (1) Place the spark plug cable assemblies in position, with the longest cable for No. 1 cylinder. Start the terminal nuts onto the spark plug (fig. 40) threads, but do not tighten until the cables are alined.
- (2) Start the terminal nuts onto the distributor cover and cap assembly (fig. 79) threads, making certain the correct firing order is maintained.
- (3) Aline the cables to avoid kinks or sharp bends. Tighten the terminal nuts.

*c. Spark Plugs Removal.*

- (1) Unscrew the four terminal nuts securing the spark plug cable assemblies (fig. 40) to the four spark plugs and disconnect the cables from the plugs. Remove all dirt from the cylinder head recesses around the spark plugs.
- (2) Remove the plugs with a deep socket wrench. Remove and discard the spark plug gaskets.

*d. Spark Plugs Installation.*

- (1) Check the spark plug electrode gap with a wire feeler gage, and adjust to 0.030 inch.

- (2) Place new gaskets over the spark plug threads. Insert the spark plugs (fig. 40) into the cylinder head and tighten to torque of 25-30 foot-pounds.
- (3) Screw the spark plug cable assembly terminal nuts onto the spark plugs.

## Section XI. STARTING SYSTEM

### 154. Description and Data

*a. Description.* The starting system (figs. 85 and 86) consists of the starter, starter switch and starter pedal, connecting electrical cables, and batteries. The auxiliary power cable receptacle with connecting cables, a part of the winterization kit, is considered a part of the starting system when a booster battery or an outside power source is used to assist in starting the engine. Refer to paragraph 162 for information relative to the batteries. A four pole, four brush, water-proof starter assembly (fig. 87) is mounted on the right side of the engine. The starter switch, an integral part of the starter, is mounted on top of the starter. A spring-loaded-type starter pedal (V, fig. 11), which extends from the driver's compartment into the engine compartment, functions to move the starter shift lever. Movement of the starter shift lever (fig. 87) shifts the starter drive pinion into engagement with the engine flywheel and also closes the starter switch contacts. The starter is equipped with an overrunning clutch-type drive which automatically disengages the starter drive pinion from the flywheel when the engine is started.

*b. Data for Starter Assembly.*

Cranking speed.....	185 rpm
Drive.....	over-running clutch
Manufacturer.....	Delco-Remy or Electric Auto-Lite
Model.....	DR-X10483 or MC1-4001UT
Starter switch assembly.....	mounted on starter
Voltage.....	24

### 155. Starter Assembly

(fig. 87)

*a. Removal.*

- (1) Disconnect the battery "B" ground cable (par. 162b(8) (a) and (b)).
- (2) Remove the nut and lockwasher securing the battery-to-starter cable, generator regulator-to-starter cable, and auxiliary power receptacle cable (if vehicle is equipped with an auxiliary power receptacle) to the starter switch assembly terminal. Pull the cables from the stud.
- (3) Remove the bolt and lockwasher securing the starter assembly to the starter support. Working at the starter bottom

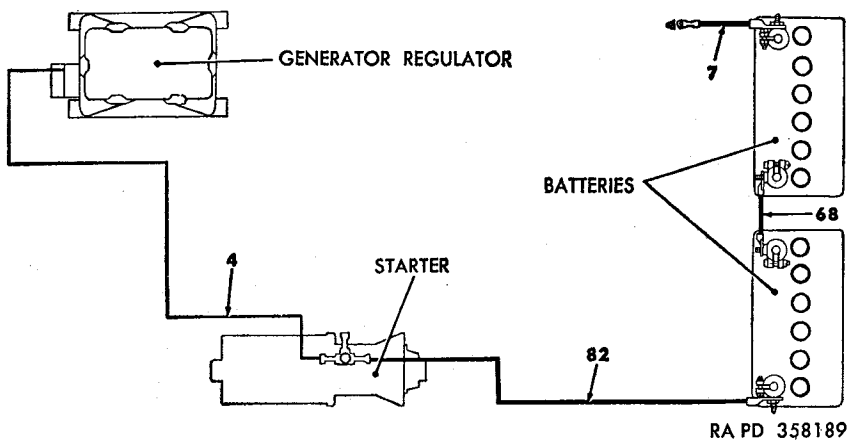

Figure 85. Starting system components and cables identification (M38A1).

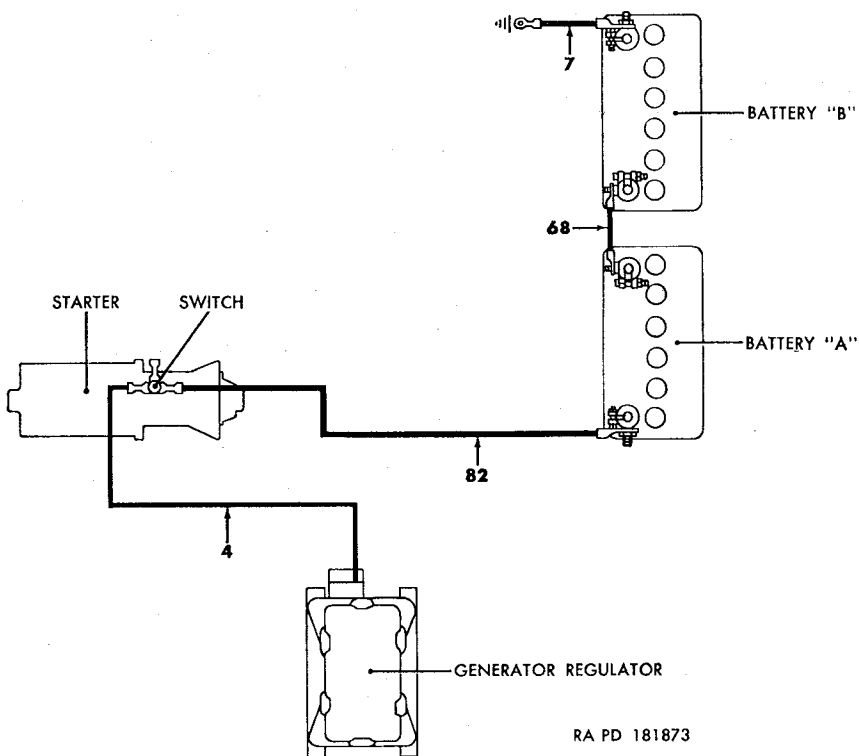

Figure 86. Starting system components and cables identification (M170).

rear, adjacent to the clutch bell housing, remove the nut and copper washer from the bolt and then remove the bolt and copper washer from the clutch and pinion housing of the starter and the clutch bell housing. Working at the starter top, adjacent to the clutch bell housing, remove the screw and lockwasher securing the clutch and pinion housing of the starter to the clutch bell housing.

- (4) Pull the starter straight forward toward the vehicle front until the clutch and pinion housing is clear of the clutch bell

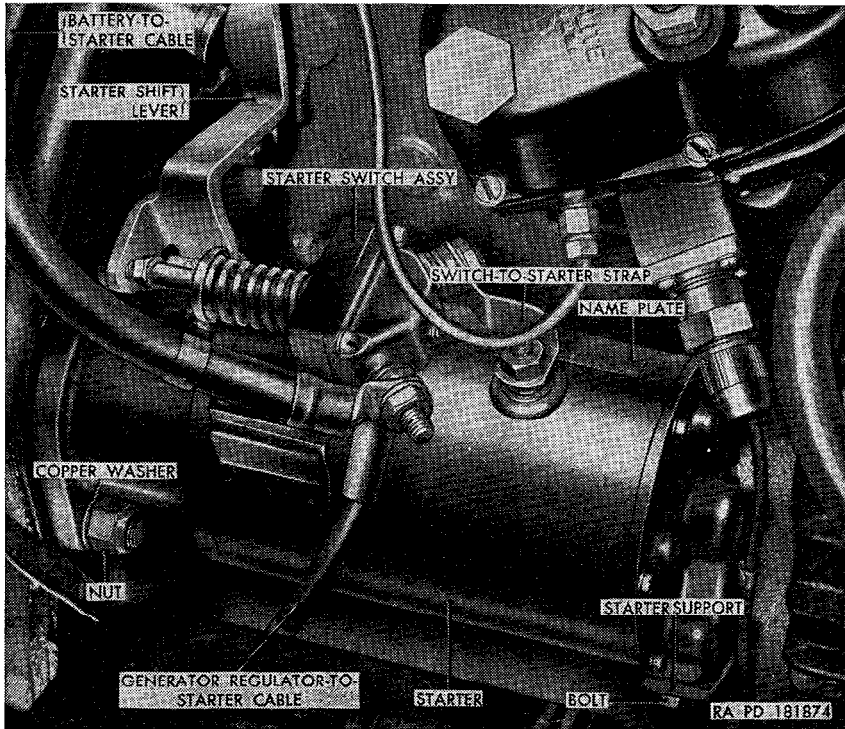

Figure 87. Starter assembly—installed.

housing, and lift the starter out of the engine compartment. Remove and discard the starter mounting gasket from either the starter or clutch bell housing.

*b. Installation.*

- (1) Make sure all the old gasket is removed from mating surfaces of the clutch and pinion housing of the starter assembly and clutch bell housing. Coat a new starter mounting gasket with plastic-type liquid cement and place the gasket in position on the starter clutch and pinion housing.
- (2) Insert the starter clutch and pinion housing into the clutch bell housing hole at the right side of the engine and position

the starter against the clutch bell housing. Place a  $\frac{1}{2}$ -inch copper washer on the  $\frac{1}{2}$  x  $3\frac{1}{2}$  bolt. Working on the bottom of the starter, adjacent to the clutch bell housing, insert the bolt through the clutch bell housing flange, through the starter clutch and pinion housing, and install a  $\frac{1}{2}$ -inch copper washer and  $\frac{1}{2}$ -inch nut on the bolt. Working on the top of the starter, secure the starter to the clutch bell housing with a  $\frac{1}{2}$ -inch lockwasher and  $\frac{1}{2}$  x  $1\frac{1}{4}$  screw. Secure the front of the starter to the starter support with a  $\frac{3}{8}$  lockwasher and  $\frac{3}{8}$  x  $\frac{7}{8}$  bolt.

- (3) Place the terminals of the auxiliary power receptacle cable (if used), generator regulator-to-starter cable, and the battery-to-starter cable on the starter switch terminal stud. Secure the cables to the stud by installing the  $\frac{3}{8}$ -inch lockwasher and nut. Coat the starter switch terminal and cable terminals with ignition insulation compound.
- (4) Connect the battery "B" ground cable (par. 162*b*(9) (*b*) and (*c*)).

## 156. Starter Switch Assembly

(fig. 87)

### *a. Removal.*

- (1) Disconnect the battery "B" ground cable (par. 162*b*(8) (*a*) and (*b*)).
- (2) Disconnect the battery-to-starter cable, generator regulator-to-starter cable, and auxiliary power receptacle cable (if used) from the starter switch assembly (par. 155*a*) terminal.
- (3) Remove the nut and lockwasher securing the switch-to-starter strap to the terminal stud on top of the starter. Remove the four screws and lockwashers, securing the starter switch to the top of the starter.
- (4) Lift the starter switch off the starter. Remove the nut and lockwasher securing the switch-to-starter strap to the switch terminal stud and lift the strap off the stud.

### *b. Installation.*

- (1) Position the straight side of the switch-to-starter strap on the starter switch assembly terminal stud, which will be nearest engine when switch is installed. Secure strap to stud with a  $\frac{3}{8}$ -inch lockwasher and nut.
- (2) Position the starter switch with the switch plunger facing the clutch bell housing, on top of the starter making sure the strap free end is installed on the starter terminal stud. Secure switch to the starter with four No. 10 x  $\frac{5}{8}$  lockwashers and screws. Secure the strap to the starter terminal stud with one  $\frac{3}{8}$ -inch lockwasher and nut.

- (3) Connect the auxiliary power receptacle cable (if used), generator regulator-to-starter cable, and battery-to-starter cable to the starter switch assembly terminal (par. 155*b*).
- (4) Connect the battery "B" ground cable (par. 162*b*(9) (*b*) and (*c*)).

## Section XII. GENERATING SYSTEM

### 157. Description and Data

*a. Description.* The 24-volt, single-wire, waterproof generating system (figs. 88 and 89) consists of the generator and generator regulator assemblies, connecting cables, and batteries. Refer to paragraph 162 for information relative to the batteries. The system functions to keep the batteries fully charged. A two-brush, 25 ampere, 24-volt generator (fig. 90), mounted on the right side of the engine, is driven in conjunction with the water pump by a matched pair of V-belts from the engine crankshaft. A belt tension brace provides for drive belt adjustment. The generator regulator (figs. 92 and 94) assembly consists of three units; the voltage regulator, which controls the generator output voltage to prevent overcharging the batteries; the current regulator, which prevents overloading the generator; and the circuit breaker, which opens to prevent discharging the batteries when the generator output falls below the level required to charge the batteries.

#### *b. Data.*

##### Generator:

Controlled output.....	25 amp
Ground polarity.....	neg
Manufacturer.....	Delco-Remy or Electric Auto-Lite
Model.....	DR-117495 or AL-GHA4802UT
Voltage.....	24

##### Generator regulator:

Amperes.....	25
Ground polarity.....	neg
Manufacturer.....	Delco-Remy or Electric Auto-Lite
Model.....	DR-118606 or AL-VBC4002UT
Voltage.....	24

### 158. Generator Assembly

**Caution:** Disconnect the batteries before attempting any work on the generator assembly. See WARNING on top of the right front fender.

#### *a. Removal.*

- (1) Disconnect the ground cable of battery "B" (par. 162*b*(8) (*a*) and (*b*)).

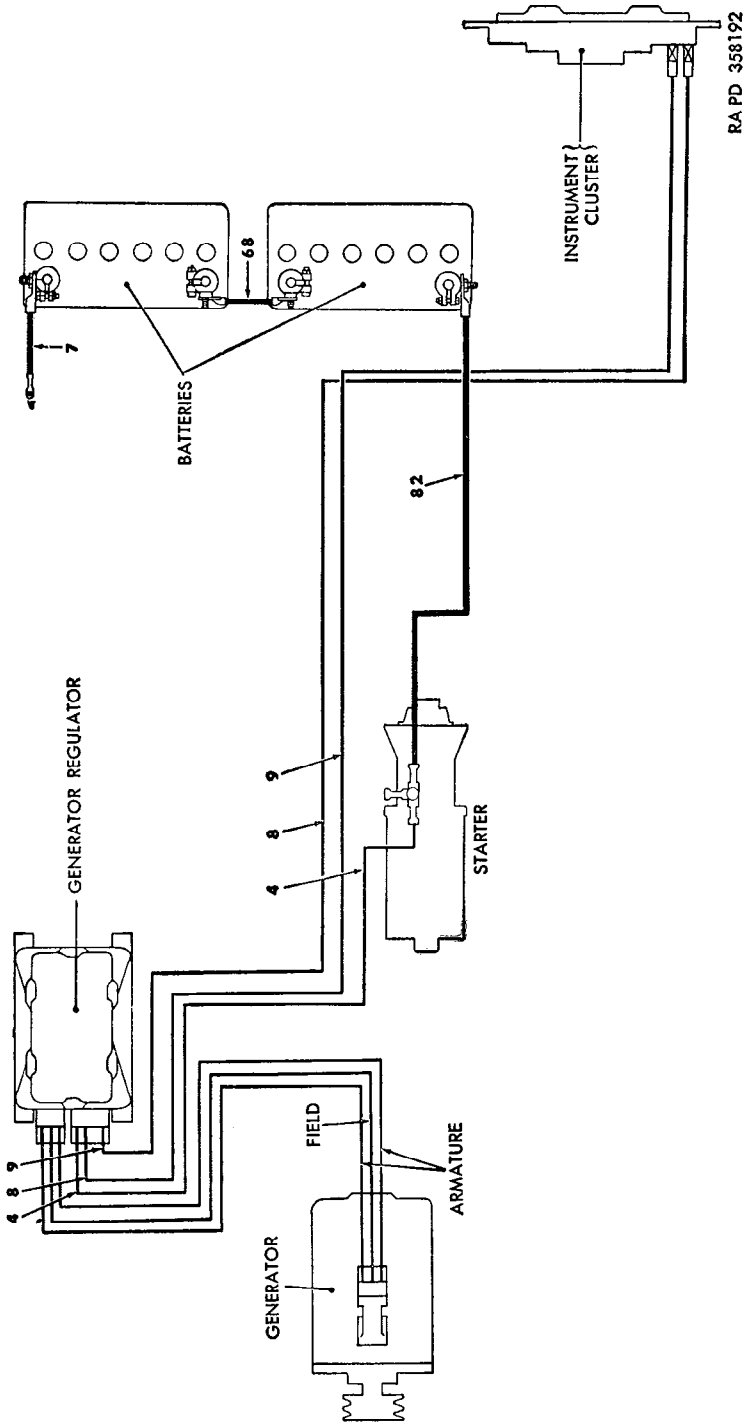

RA PD 358192

Figure 88. Generating system components and cables identification (M3841).



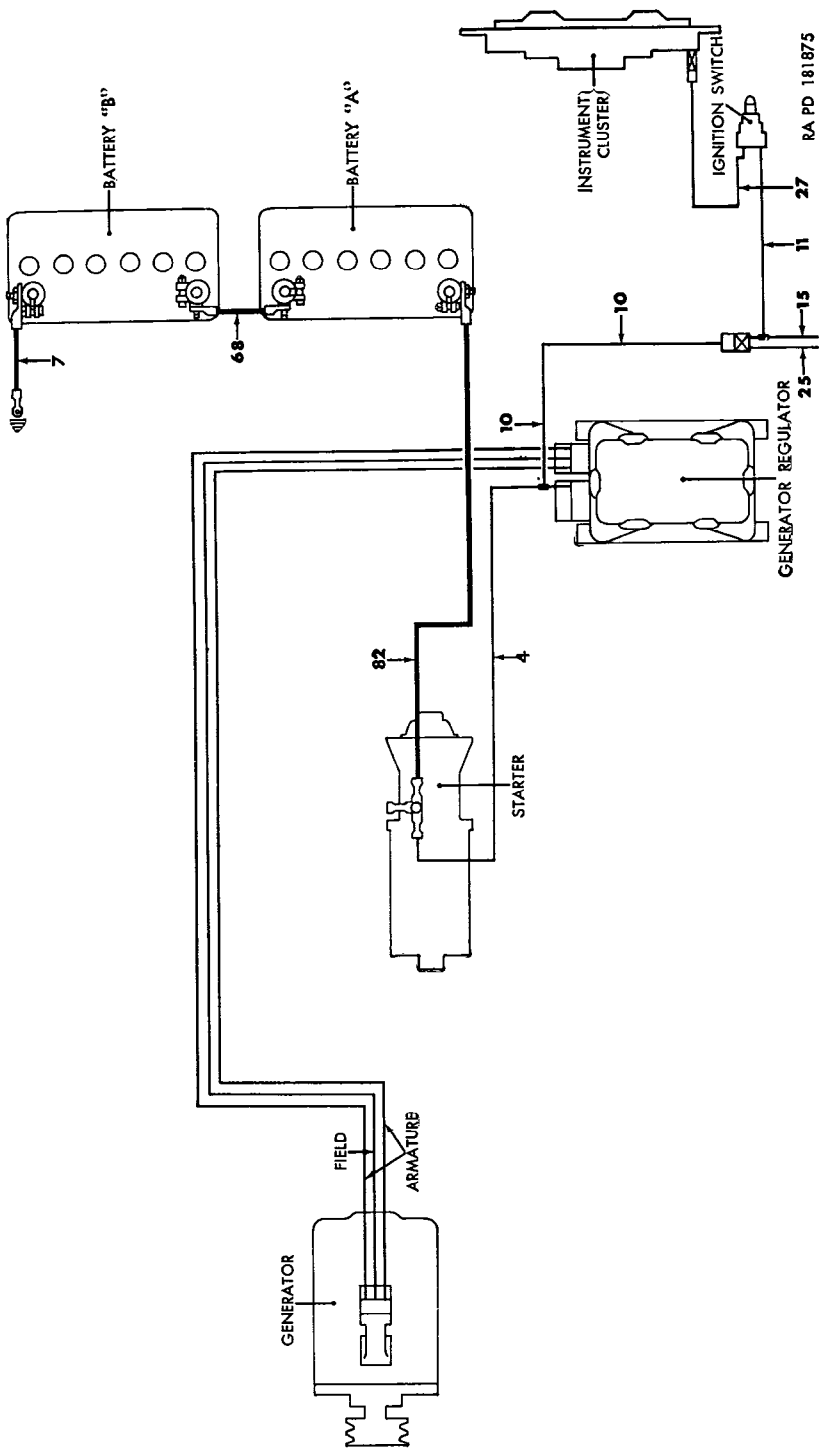

Figure 89. Generating system components and cables identification (MI70).

- (2) Unscrew the coupling nut securing the generator-to-generator regulator cable (fig. 90) to the wiring harness receptacle. Pull the cable plug from the receptacle.
- (3) Remove the lockwasher screw and lockwasher securing the belt tension brace to the drive end head. Swing the generator toward the engine as far as it will go, and remove the two fan and generator drive belts from the drive pulley. If the belt tension brace is to be removed, remove the bolt, nut, and lockwasher securing the brace inner end to the engine front mounting plate, and remove the brace.

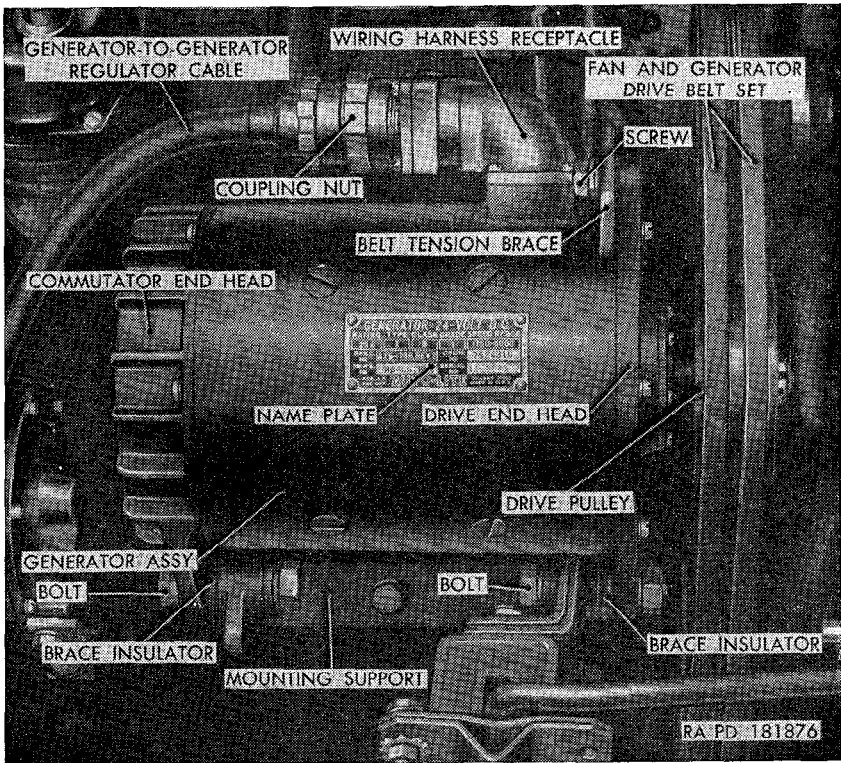

Figure 90. Generator assembly—installed.

- (4) Remove the nut and external-teeth lockwasher from the bolt securing the commutator end head to the mounting support. Remove the bolt and flat washer from the commutator end head and mounting support.

*Note.* Another flat washer is used on the bolt. The washer, which is adjacent to the brace insulator in the mounting support on the nut side of the bolt, may drop when the bolt is removed. Recover or remove the flat washer after removing the generator.

- (5) Disconnect the drive end head from the engine front mounting support in the same manner as that outlined for the commutator end head ((4) above).
- (6) Lift the generator straight up until it clears the brace insulators in the mounting support and engine front mounting plate, and remove the generator.
- (7) Remove the cotter pin, castellated nut, and lockwasher securing the drive pulley to the armature shaft. Using a conventional puller, pull the drive pulley off the shaft. Remove the woodruff key from the shaft. Discard cotter pin.

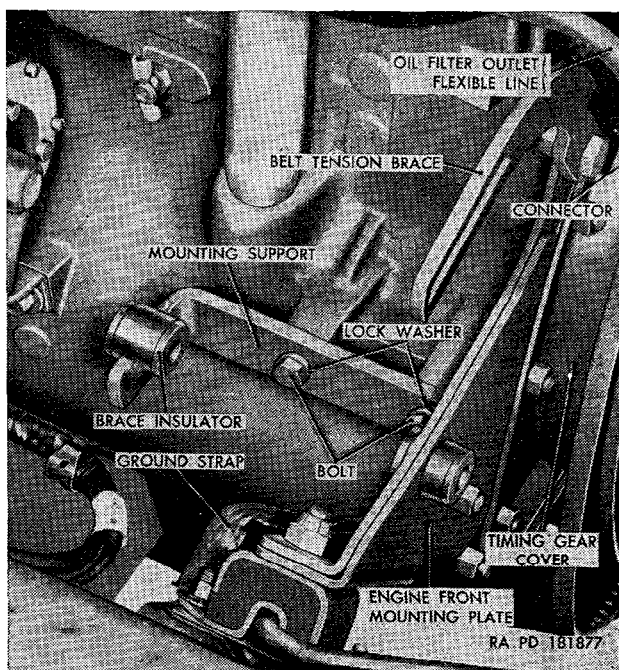

Figure 91. Generator mounting support—installed.

- (8) Inspect the two brace insulators (fig. 91) for damaged or deteriorated condition. One insulator is mounted in the mounting support, while the other is mounted in the engine front mounting plate. If the insulators are damaged, remove them.
- (9) Remove the two bolts and lockwashers securing the mounting support to the cylinder block and remove the support.

*b. Insulation.*

- (1) Place the mounting support (fig. 91) in position on the right side of the cylinder block. Secure the support to the block with two  $\frac{3}{8}$ -inch lockwashers and  $\frac{3}{8}$  x  $\frac{7}{8}$  bolts.

- (2) Install the brace insulators if removed, one in the mounting support and one in the engine front mounting plate.
- (3) Install the  $\frac{1}{8} \times \frac{7}{8}$  woodruff key in the generator armature shaft keyway. Aline the keyway in the drive pulley (fig. 90) bore with the key in the shaft and install the pulley (long end of hub leading) on the shaft. Shove the pulley onto the shaft until the pulley inner end rests against the shaft shoulder. Install one  $\frac{1}{2}$ -inch lockwasher on shaft against pulley outer end and secure pulley to shaft with one  $\frac{1}{2}$ -inch castellated nut. Tighten nut as much as possible and then aline shaft cotter pin hole with nut serrations. Lock the nut to the shaft with a new  $\frac{3}{32} \times 1$  cotter pin. Bend the cotter pin ends over.
- (4) If the belt tension brace was removed, secure it to the engine front mounting plate with a  $\frac{3}{8} \times \frac{7}{8}$  bolt,  $\frac{3}{8}$ -inch lockwasher, and  $\frac{3}{8}$ -inch nut. Position brace so its curved end faces down.
- (5) Lower the generator assembly into the engine compartment and position its commutator and drive end heads on the brace insulators, mounted in the mounting support and engine front mounting plate.
- (6) Start one  $\frac{7}{16} \times 2\frac{1}{4}$  bolt with  $1\frac{7}{32}$ -inch ID flat washer through the mounting support brace insulator. Place one  $1\frac{5}{32}$ -inch ID flat washer between the generator insulator and commutator end head. Push the bolt through the flat washer and commutator end head. Place one  $\frac{7}{16}$ -inch external-teeth lockwasher over the bolt end and install the  $\frac{7}{16}$ -inch nut, but do not tighten.
- (7) Start one  $\frac{7}{16} \times 2\frac{1}{4}$  bolt with  $1\frac{7}{32}$ -inch ID flat washer through the engine front mounting plate brace insulator. Place one  $1\frac{5}{32}$ -inch ID flat washer between the generator insulator and drive end head, and push the bolt through the washer and drive end head. Place one  $\frac{7}{16}$ -inch external-teeth lockwasher over the bolt end and install a  $\frac{7}{16}$ -inch nut, but do not tighten.
- (8) Position the fan and generator drive belts over the drive pulley and pull the generator away from the engine until belts are snug in place in all pulleys. Place the  $\frac{3}{8}$ -inch flat washer over the  $\frac{3}{8} \times 1$  lockwasher screw and insert screw through the belt tension brace slot and into the generator drive end head. Start screw into drive end head threads, but do not tighten.
- (9) Adjust belt tension (par. 130a).
- (10) Tighten the nuts and bolts securing the generator to the mounting support and engine front mounting plate.
- (11) Insert the generator-to-generator regulator cable plug into the wiring harness receptacle, making sure to aline the plug

slot with the receptacle pin. Push the pin in as far as possible and screw the coupling nut onto the receptacle, using a spanner wrench.

- (12) Connect the ground cable of battery "B" (par. 162*b*(9)(*b*) and (*c*)).

## 159. Generator Regulator Assembly (M38A1)

**Caution:** Disconnect the batteries before attempting any work on the generator regulator assembly. See **WARNING** on top of the generator regulator cover and on top of the right front fender.

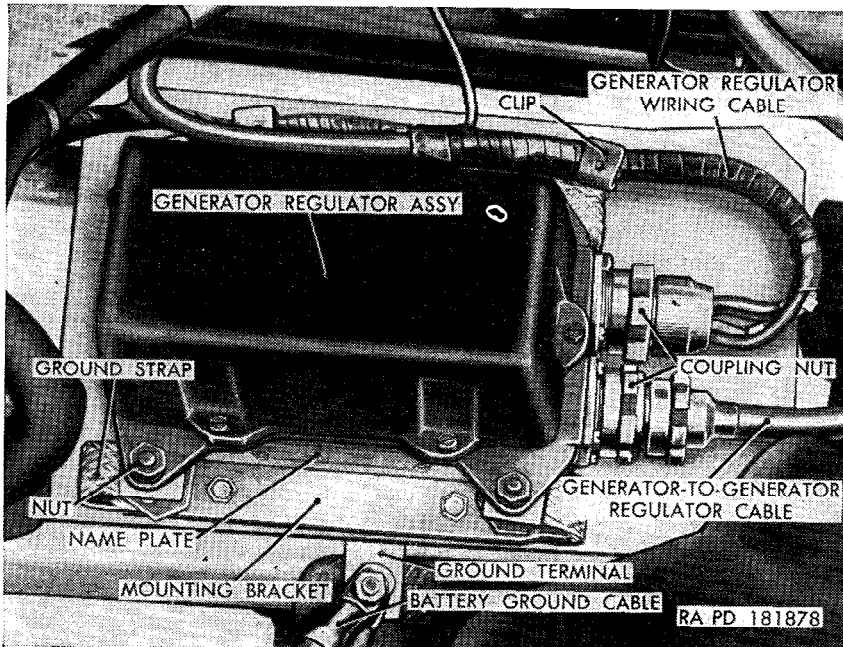

Figure 92. Generator regulator assembly installed (M38A1).

### a. Removal.

- (1) Disconnect the ground cable of battery "B" (par 162*b*(8)(*a*) and (*b*)).
- (2) Using a spanner wrench, unscrew the coupling nut of the generator-to-generator regulator cable (fig. 92) and pull the cable plug out of the receptacle.
- (3) Using a spanner wrench, unscrew the generator regulator wiring cable coupling nut and pull the cable plug out of the receptacle.
- (4) Remove the four plain nuts and lockwashers securing the generator regulator assembly to the mounting bracket cush-

ion studs. Lift the generator regulator straight up until holes in base clear studs, and remove the regulator.

- (5) Remove the two lockwasher screws securing each of the two mounting brackets (fig. 93) to the shield and support. Lift the two mounting brackets off the shield. Unscrew the two mounting bracket cushion studs from each mounting bracket. Lift the ground strap from the stud in each mounting bracket cushion.
- (6) Free the generator regulator wiring cable from the two wiring clips mounted in the shield. Remove the screw and

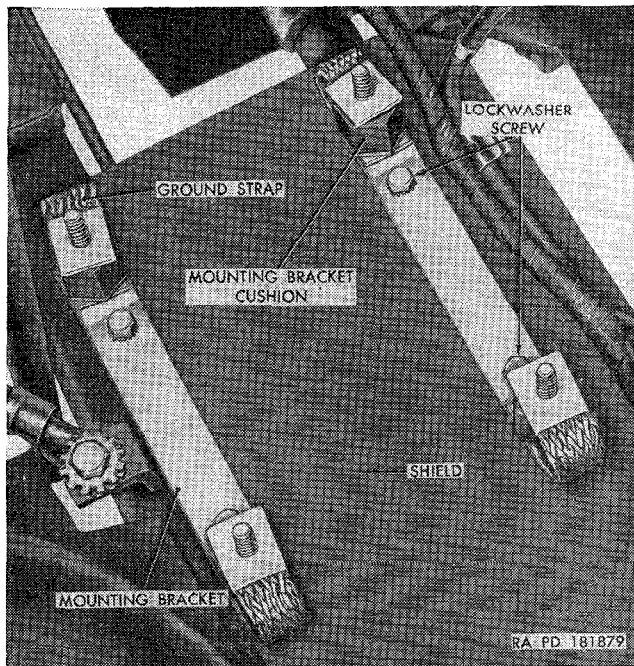

Figure 93. Generator regulator mounting brackets—installed (M38A1).

flat washer securing the shield front to the frame right side rail. Lift the shield from the engine and the two wiring clips from the shield.

*b. Installation.*

- (1) Install the two wiring clips in the shield (fig. 93). Position the shield on the support welded to the frame right side rail. Secure the shield front to the frame right side rail with one flat washer and screw.
- (2) Install one end of a ground strap on one side of the stud protruding from one mounting bracket cushion (fig. 93). Install the other end of the strap on the other side of the

stud. Install a ground strap on the other three cushions in the same manner. Install two mounting bracket cushions on each of the two mounting brackets by screwing the stud short ends in the cushions into the bracket outer holes, making sure the bracket indented side is down. Screw studs into brackets as far as possible, making sure the ground straps face away from the bracket center. Position the two mounting brackets on top of the support shield. Secure the brackets to the shield and support with four  $\frac{1}{4} \times \frac{3}{4}$  lock-washer screws.

- (3) Position the holes in the base of the generator regulator assembly (fig. 92) (receptacles facing front of vehicle) over the studs of the mounting bracket cushions. Secure the regulator to the cushions with four  $\frac{5}{16}$ -inch lockwashers and  $\frac{5}{16}$ -inch plain nuts.
- (4) Insert the generator regulator wiring cable plug into the inner receptacle on the front of the generator regulator, making sure to aline the plug slot with the receptacle pin. Connect the plug to the receptacle by screwing the coupling nut onto the receptacle, using a spanner wrench.
- (5) Connect the generator-to-generator regulator cable (fig. 92) to the outer receptacle on the generator regulator in the same manner as described in (4) above for the generator regulator wiring cable.
- (6) Connect the ground cable of battery "B" (par. 162(b)(9)(b) and (c)).

## 160. Generator Regulator Assembly (M170)

(fig. 94)

**Caution:** Disconnect the batteries before attempting any work on the generator regulator assembly. See **WARNING** on the top of the generator regulator cover and on top of the left front fender.

### a. Removal.

- (1) Disconnect the ground cable of battery "B" (par. 162b(8)(a) and (b)).
- (2) Using a spanner wrench, unscrew the generator-to-generator regulator cable coupling nut, and pull the cable plug out of the receptacle.
- (3) Using a spanner wrench, unscrew the generator regulator wiring cable coupling nut and pull the cable plug out of the receptacle.
- (4) Remove the four plain nuts and lockwashers securing the generator regulator assembly to the mounting bracket cushion studs. Slide the generator regulator forward until holes in base clear studs, and remove the regulator.

- (5) Remove the two lockwasher screws securing each of the two mounting brackets to the dash, and remove the brackets. Unscrew the two mounting bracket cushion studs from each mounting bracket. Remove the ground strap from the stud in each mounting bracket cushion.

*b. Installation.*

- (1) Install one end of a ground strap on one side of the stud protruding from one mounting bracket cushion. Install the other end of the strap on the other side of the stud. Install a ground strap on the other three cushions in the same manner. Install two mounting bracket cushions on each of the two mounting brackets, by screwing the stud short ends in the cushions into the bracket outer holes, making sure the bracket

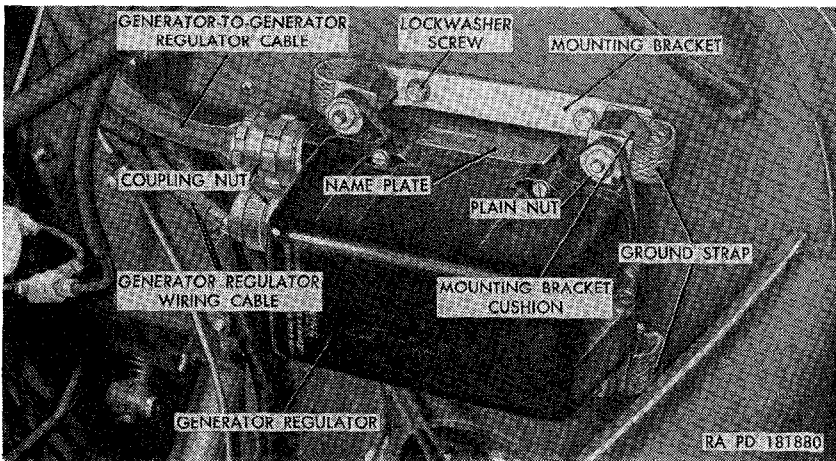

*Figure 94. Generator regulator assembly—installed (M170).*

- indented side is against the dash. Screw studs into brackets as far as possible, making sure the ground straps face away from the bracket center. Secure the brackets to the dash with four  $\frac{1}{4} \times \frac{3}{4}$  lockwasher screws.
- (2) Position the holes in the base of the generator regulator assembly (receptacles facing the right side of the vehicle) on the mounting bracket cushion studs. Secure the regulator to the cushions with four  $\frac{5}{16}$ -inch lockwashers and  $\frac{5}{16}$ -inch plain nuts.
  - (3) Insert the generator regulator wiring cable plug into the inner receptacle in the generator regulator end, making sure to aline the plug slot with the receptacle pin. Connect the plug to the receptacle by screwing the coupling nut onto the receptacle, using a spanner wrench.



- (4) Connect the generator-to-generator regulator cable to the outer receptacle on the generator in the same manner as described in (3) above for the generator regulator wiring cable.
- (5) Connect the ground cable of battery "B" (par. 162*b*(9)(*b*) and (*c*)).

## Section XIII. BATTERIES AND LIGHTING SYSTEM

### 161. Description and Data

#### *a. Description.*

- (1) *General.* The 24-volt batteries and lighting system (figs. 95 and 96) is completely waterproofed. All cable connectors are bayonet-type with interlocking sleeves. Rubber grommets in the sleeves protect the connections from moisture. A single circuit breaker in the generator regulator protects both the ignition and lighting systems from overload. All light circuits are controlled by the light switch (E, fig. 13) on the instrument panel. The continuity of all circuits is described in paragraph 171, table IV, and cables are identified by number in figures 95 and 96. On the vehicle, cables are identified by numbered tags near each cable end.
- (2) *Batteries* (fig. 99). The 24-volt primary circuit is supplied by two 12-volt lead- and acid-type storage batteries, connected in series. The batteries and connections are designed for under water operation. The batteries compartment is in front of the dash on the right side of the vehicle.
- (3) *Service headlights* (fig. 101). The sealed beam-type service headlights are mounted in the radiator grille. High or low beam is selected by a foot-operated switch.
- (4) *Blackout driving light* (fig. 104). A single blackout driving light is mounted on the left front fender. This driving light supplies a diffused, low-intensity light beam, for use when the tactical situation prohibits use of the service headlights.
- (5) *Signal blackout marker and service parking lights* (fig. 105). Two light assemblies, one mounted directly below each service headlight, serve the dual purpose of signal blackout marker lights and service parking lights.
- (6) *Blackout tail and stop light* (fig. 106). The blackout tail and stop light is mounted on the right rear corner of the vehicle body. The unit includes two lamps, a blackout stop light in the upper half, and a blackout taillight in the lower half.
- (7) *Service tail and stop light assembly* (fig. 107). The service tail and stop light assembly is mounted in the left rear corner of the vehicle body. The upper half of the assembly houses

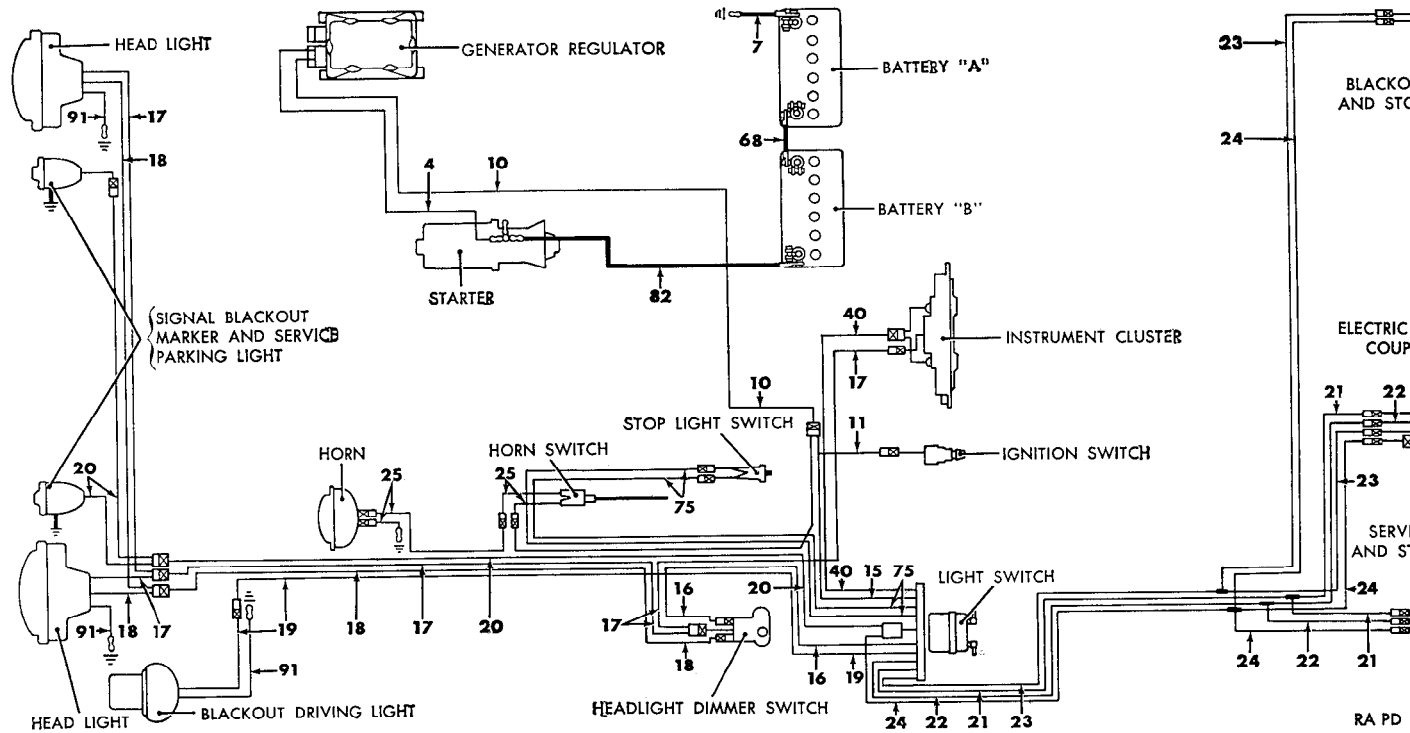

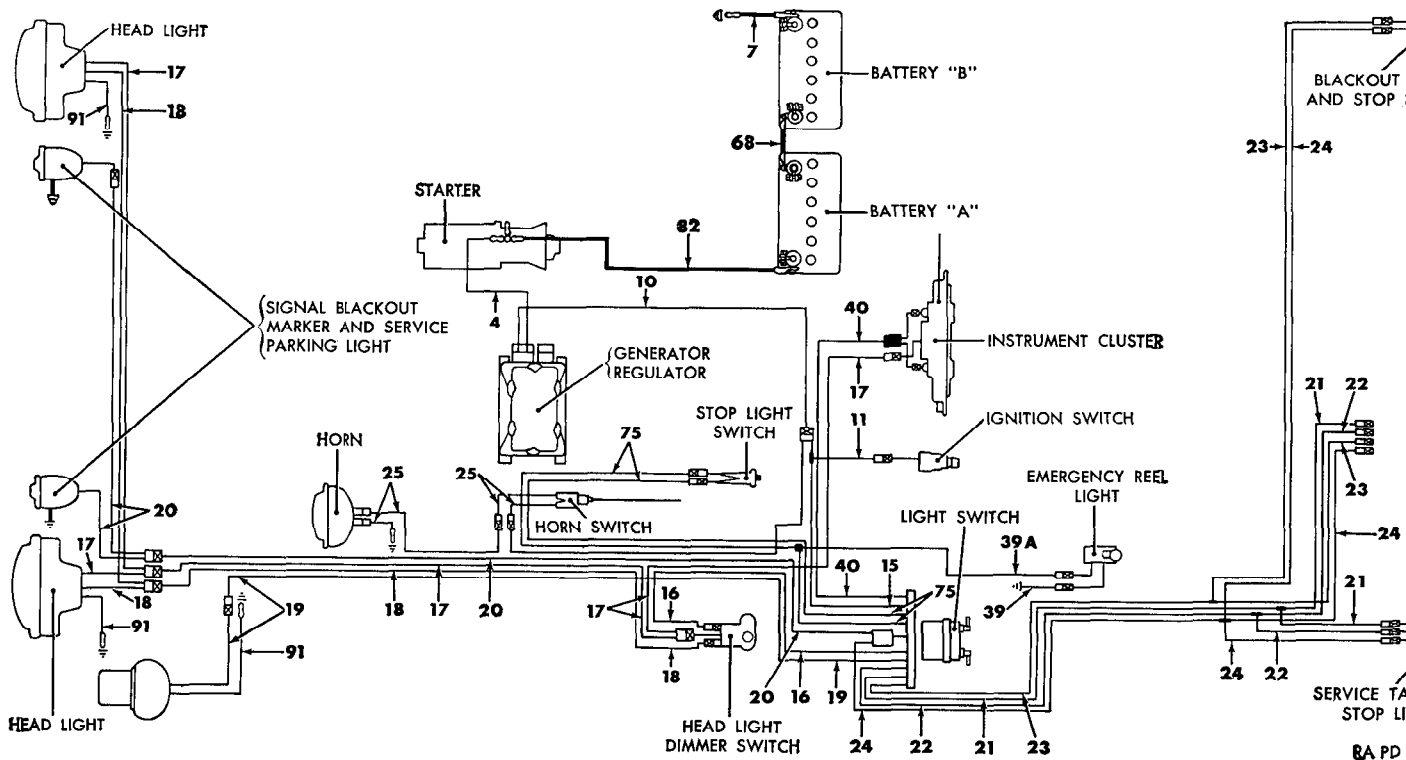

Figure 96. Batteries and lighting system components and cable identification (M170).

two lamp units, a service taillight, and a service stop light. The lower half houses a single lamp unit, a blackout taillight.

- (8) *Trailer coupling electrical connector receptacle* (fig. 108) A four-terminal receptacle is mounted on the left rear corner of the body of the utility truck M38A1. This receptacle provides a means of connecting the electrical units of a towed trailer to the vehicle electrical system. When connected, trailer lights are controlled by the towing vehicle light switch.
- (9) *Emergency reel lamp* (fig. 109). An emergency reel lamp is mounted on the body of the front line ambulance M170 to the left and to the rear of the driver's seat. Voltage is available at the lamp switch if any of the vehicle lighting circuits are turned on.

*b. Battery Data.*

Manufacturer .....	Electric Auto-Lite
Model .....	2 HH
Voltage .....	12
Plates per cell .....	11
Type .....	waterproof
Number of batteries used .....	2
How connected .....	series for 24v

## 162. Batteries and Battery Cables

*a. Batteries.* For purposes of identification, the left battery (fig. 99) is referred to as battery "A," and the right battery as battery "B."

- (1) *Specific gravity test.* Refer to TM 9-2857 for instructions on performing specific gravity test.
- (2) *Adding water.* Refer to TM 9-2857 for instructions on adding water.
- (3) *Cleaning.* Refer to TM 9-2857 for cleaning.
- (4) *Battery "A" removal.*
  - (a) Loosen the eight thumb screws (fig. 97) securing batteries cover in position on M38A1. Slide cover toward right side of vehicle to disengage it from thumb screws, and remove cover.

*Note.* On the M170, the clamp is raised to remove the batteries cover (fig. 98).

- (b) Remove the negative post terminal with bolt and nut assembly, and positive post terminal with bolt and nut assembly (*b(8) (c) below*).
- (c) Remove the two wing nuts from the holddown frame bolts and lift holddown frame assembly off bolts and battery.
- (d) Lift battery out of batteries compartment.

**Caution:** Do not use a lifting strap that fastens to battery posts, as damage to battery will result.

- (5) *Battery "B" removal* (fig. 99). Battery "B" removal is the same as battery "A" removal ((4) above).
- (6) *Battery "A" installation.*
  - (a) Lower battery "A" (fig. 99) into batteries compartment with the positive post facing left side of vehicle (see Caution (4) (d) above).
  - (b) Install holddown frame assembly on holddown bolts and battery, then secure frame in position with two  $\frac{5}{16}$ -inch wing nuts.

*Note.* In order to prevent any possibility of excessive battery movement, make sure to install lockwashers under the wing nuts.

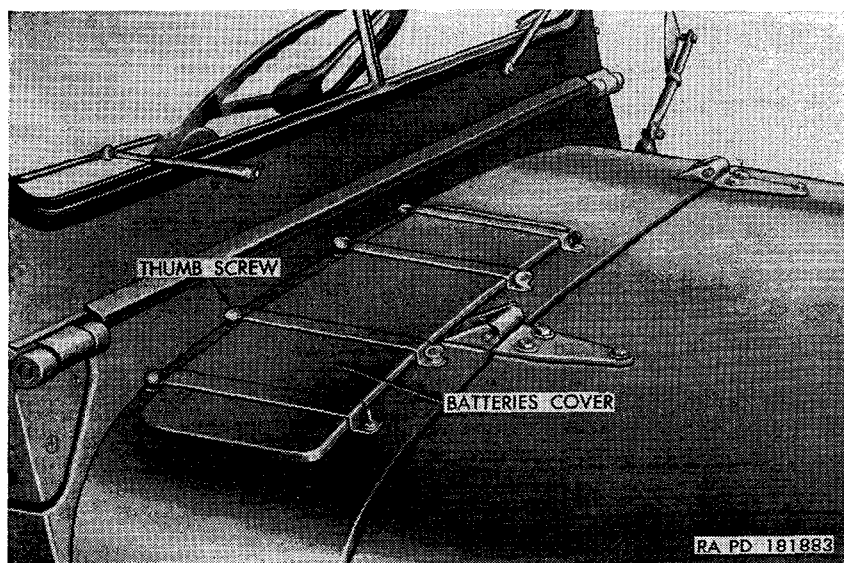

Figure 97. Batteries location—batteries cover installed (M38A1).

- (c) Install the negative post terminal with bolt and nut assembly and positive post terminal with bolt and nut assembly (b(9) (a) below).
- (d) Position the batteries cover (fig. 97) on M38A1 over batteries compartment and slide towards left side of vehicle to engage cover slots with thumb screws, then tighten thumb screws securely.
 

*Note.* On the M170, the hinged cover is lowered and clamped on (fig. 98).
- (e) Check polarity ((8) below).
- (7) *Battery "B" installation* (fig. 99). Battery "B" installation is the same as battery "A" installation ((6) above).
- (8) *Polarity test.* Test polarity by turning on headlights. If lights illuminate, and ammeter registers DIS, polarity is

correct. If the lights illuminate, and ammeter registers no apparent reading, one battery is reversed. If headlights illuminate, and ammeter registers CHG, both batteries are reversed. Correct installation as necessary.

*b. Cables and Cable Terminals.*

- (1) *Cleaning.* Refer to TM 9-2857 for instructions on cleaning.
- (2) *Ground cable assembly 7 removal.*
  - (a) Remove batteries cover (a(4) (a) above).
  - (b) Remove the ground cable 7 from battery "B" ((8) (b) below).
  - (c) Remove the lockwasher screws from the two clips securing cable to dash and to fender splash apron (fig. 181). Spread clips and remove from cable.

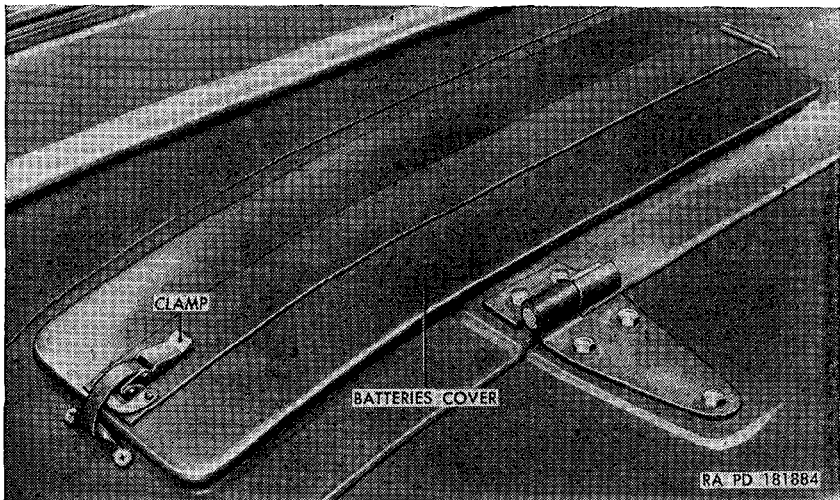

Figure 98. Batteries location—batteries cover installed (M170).

- (d) Remove the bolt and two lockwashers securing cable to mounting bracket welded to the frame side rail at right of generator regulator (fig. 92).
  - (e) Withdraw cable from batteries compartment (fig. 99) and remove from vehicle.
- (3) *Ground cable assembly No. 7 installation.*
- (a) Install a  $\frac{3}{8}$ -inch lockwasher on a  $\frac{3}{8}$  x  $\frac{7}{8}$  bolt and insert bolt through one terminal end of ground cable assembly. Install another  $\frac{3}{8}$ -inch lockwasher on the bolt and thread bolt into ground cable mounting bracket welded to frame side rail at right of generator regulator (fig. 92).
  - (b) Insert other terminal end of cable through grommet in dash and into batteries compartment. Install cable 7 ((9) (b) below).

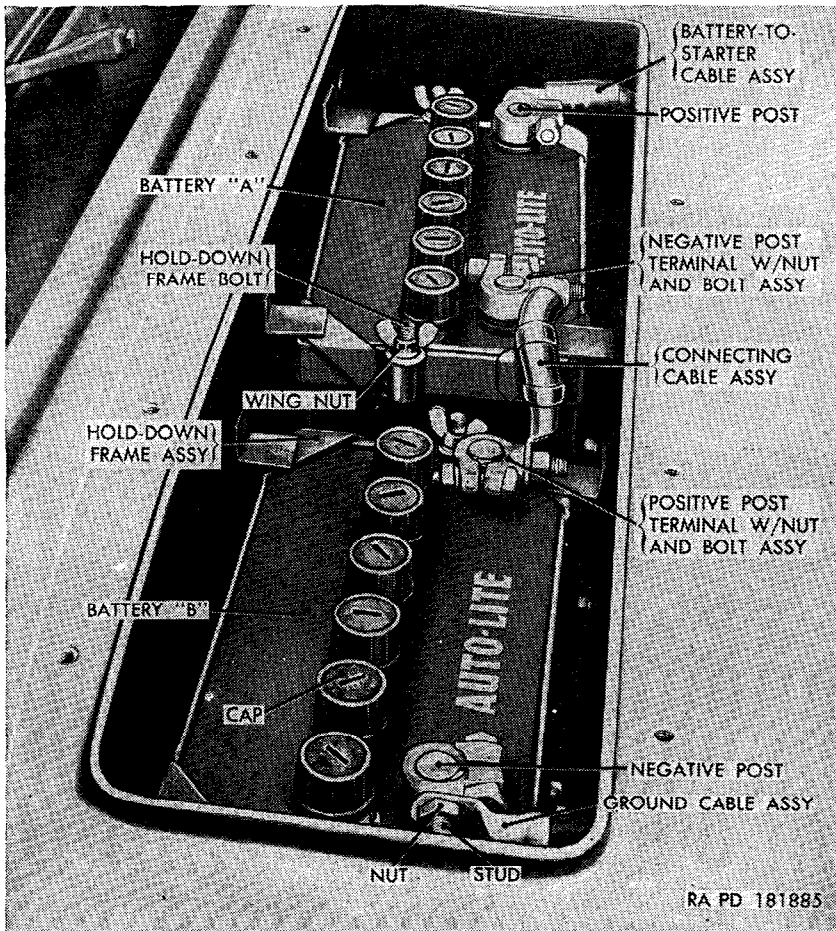

Figure 99. Batteries installed—batteries cover removed.

- (c) Position a  $\frac{5}{8}$ -inch clip on the ground cable and secure clip to dash with a No. 10 x  $\frac{1}{2}$  lockwasher screw. Position another  $\frac{5}{8}$ -inch clip on the cable and secure to fender splash apron with a No. 10 x  $\frac{1}{2}$  lockwasher screw.
- (d) Install batteries cover (a(6)(d) above).
- (4) *Battery-to-starter cable assembly No. 82 removal.*
  - (a) Remove batteries cover (a(4)(a) above).
  - (b) Remove the battery-to-starter cable 82 ((8)(b) below).
  - (c) Remove the lockwasher screw from the clip securing the cable to the dash, spread clip, and remove from cable.
  - (d) Remove the nut and lockwasher securing the cable to starter switch terminal and pull cable off terminal (fig. 87).
  - (e) Withdraw cable from batteries compartment and remove from vehicle.

- (5) *Battery-to-starter cable assembly No. 82 installation.*
- (a) Position one terminal end of battery-to-starter cable assembly on starter switch terminal, and secure in position with a  $\frac{3}{8}$ -inch light lockwasher and  $\frac{3}{8}$ -inch nut (fig. 87).
  - (b) Insert other terminal end of cable through grommet in dash and into batteries compartment. Install cable 82 ((9) (b) below).
  - (c) Position a  $\frac{5}{8}$ -inch clip on cable and secure clip to dash with a No. 10 x  $\frac{1}{2}$  lockwasher screw.
  - (d) Install batteries cover (a(6) (d) above).
- (6) *Connecting cable assembly No. 68 removal* (fig. 99).
- (a) Remove batteries cover (a(4) (a) above).
  - (b) Remove the connecting cable assembly from battery "A" and "B" ((8) (b) below).
- (7) *Connecting cable assembly No. 68 installation* (fig. 99).
- (a) Install the connecting cable assembly to battery "A" and "B" ((9) (b) below).
  - (b) Install batteries cover (a(6) (d) above).
- (8) *Battery cable terminal with bolt and nut assembly removal* (fig. 99).

*Note.* The removal procedure for positive post terminal or negative post terminal on battery "A" or battery "B" is the same.

- (a) Remove the batteries cover (a(4) (a) above).
  - (b) Remove the nut securing the cable to the integral stud of the terminal with bolt and nut assembly and pull cable off stud.
  - (c) Loosen the terminal nut and bolt and pull terminal off post.
- (9) *Battery cable terminal with bolt and nut assembly installation* (fig. 99).

*Note.* The installation procedure for positive post terminal or negative post terminal on battery "A" or battery "B" is the same.

- (a) Position the terminal on post and tighten nut and bolt.
- (b) Position cable on integral stud of terminal with bolt and nut assembly and secure with a  $\frac{3}{8}$ -inch nut.
- (c) Install batteries cover (a(6) (d) above).

## 163. Headlights

### a. Adjustment.

- (1) Place the unloaded vehicle on a smooth, level, horizontal surface so the headlights are 25 feet from a vertical wall or other vertical surface. The center line of the vehicle should be at right angles to the vertical surface.
- (2) Measure the height of the headlight center from the floor, and mark a horizontal line at this height on the vertical surface (X-X, fig. 100).



- (3) Mark line A-A, one-twelfth the distance between X-X and the horizontal surface, below X-X (fig. 100).
- (4) Measure the distance from the center of the left headlight to the center of the right headlight. Scribe this dimension on line X-X and then mark vertical lines B-B and C-C as shown in figure 100.
- (5) Turn on headlights at light switch and select high beam with dimmer switch. It is not necessary to make adjustment on low beam.
- (6) Cover one headlight while adjusting (aiming) the other. Aim headlight so center of hot spot registers with intersecting lines A-A and B-B, or A-A and C-C respectively (fig. 100).
- (7) Remove headlight door (*b(1)(a)* below).

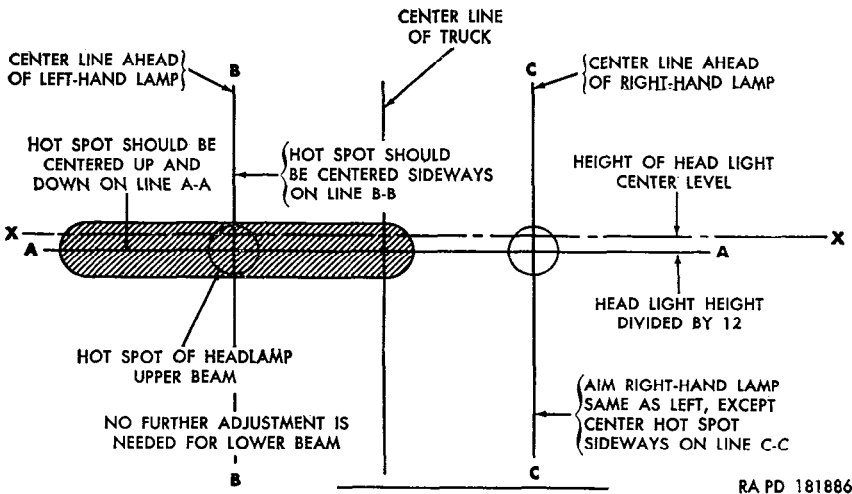

Figure 100. Headlight adjustment chart.

- (8) Adjust headlight beam by the adjusting screws shown in figure 101. Top adjusting screw provides vertical adjustment and side screw provides horizontal adjustment. Turn adjusting screws as necessary to obtain beam pattern as shown in figure 100. Adjust opposite headlight in same manner.
- (9) Install headlight door assembly (*b(2)(d)* below). Turn off headlights.

*b. Lamp-Unit with Cables Assembly.*

(1) *Removal.*

- (a) Loosen the three door assembly screws and pull the door off the headlight housing assembly.
- (b) Loosen the three lamp-unit retaining ring screws (fig. 101). Turn the ring counterclockwise and remove from the lamp-unit.

- (c) Lift lamp-unit out of the mounting assembly and pull the cable connectors out of the clips in the housing assembly (fig. 102).
  - (d) Disconnect the cable connectors and remove the lamp-unit from the vehicle.
- (2) *Installation.*
- (a) Position the lamp-unit at housing assembly and connect the cable connectors (fig. 102) of cables 17, 18, and 91.
  - (b) Press the three cable connectors into the clips in the mounting housing.

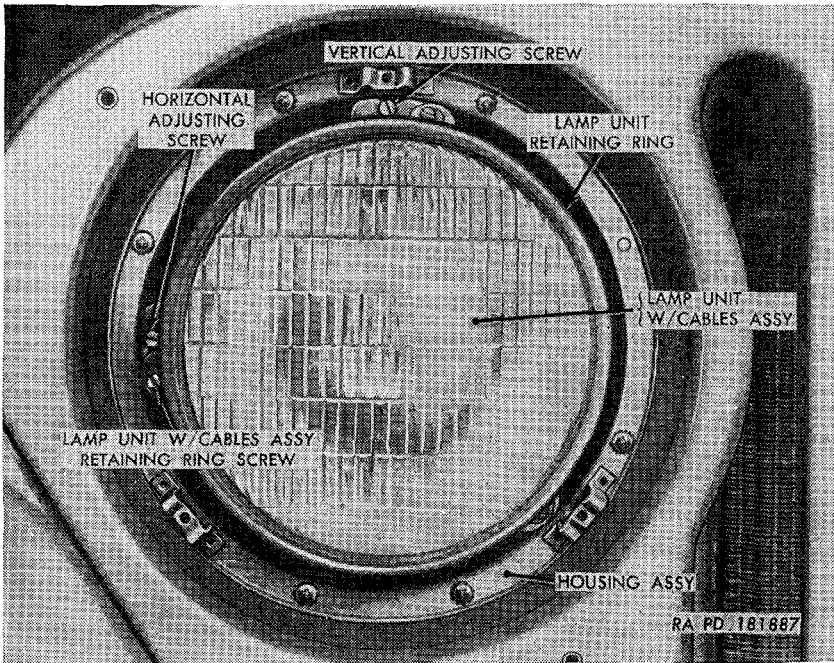

Figure 101. Headlight assembly—door removed.

- (c) Position the lamp-unit into the mounting housing. Install the lamp-unit retaining ring over the three retaining ring screws. Turn the ring clockwise to lock and tighten the screws.
  - (d) Install the door assembly on the headlight housing assembly aligning the three door assembly screws with the holes in the housing assembly mounting brackets. Start the screws into the bracket holes and tighten evenly.
- c. *Headlight Assembly Removal.*
- (1) Follow procedure in b(1) above.

- (2) Remove the grommet, headlight cable assembly, and the ground cable 91 from the headlight housing assembly (fig. 104).
- (3) Remove the seven lockwasher screws from the front, and one lockwasher screw from the rear, securing the headlight housing assembly and the ground cable 91, to the radiator guard assembly, and remove the headlight housing assembly with the lamp-unit mounting assembly (fig. 102) and the headlight assembly mounting pad from the vehicle.

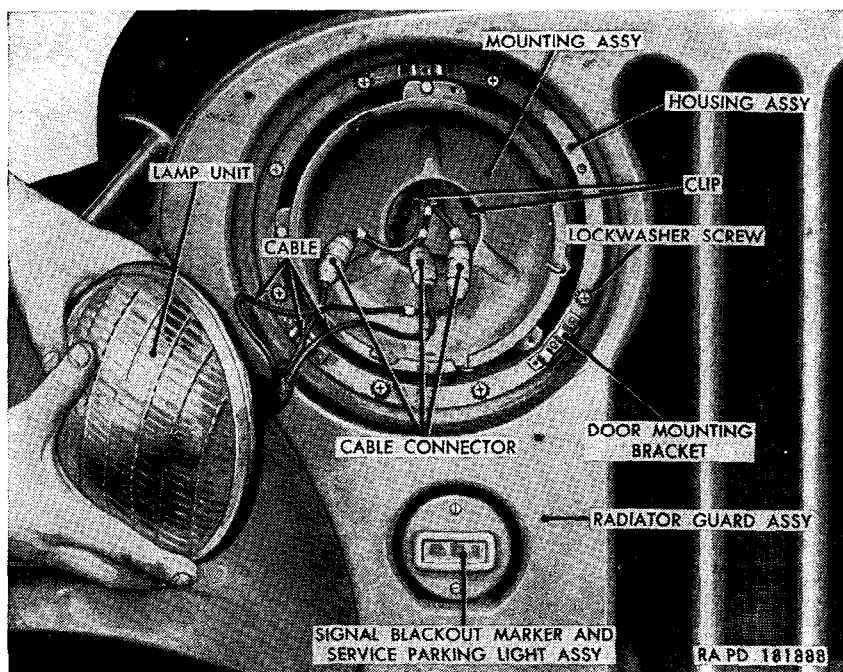

Figure 102. Removing headlight lamp-unit with cables assembly.

*d. Headlight Assembly Installation.*

- (1) Position the mounting pad on the rear of the housing assembly and align pad mounting holes with housing mounting holes.
- (2) Position the housing assembly and mounting pad in radiator guard assembly (fig. 102) and align housing and pad mounting holes with radiator guard mounting holes. Secure housing and pad to guard with seven No. 10 x 1/2 lockwasher screws from the front. Position the cable 91 (fig. 104) on the guard assembly at the rear and install a No. 10 x 1/2 lockwasher screw.

- (3) Insert headlight cable assembly and cable 91 through the hole in the top of the headlight housing assembly and press grommet into hole. Pull cables to front of housing far enough to connect lamp-unit.
- (4) Follow procedure in *b*(2) above.

## 164. Blackout Driving Light

### *a. Lamp-Unit with Cables Replacement.*

#### (1) *Removal.*

- (a) Loosen the three door assembly bolts and pull the door and lamp-unit with cables free from the housing (fig. 103).

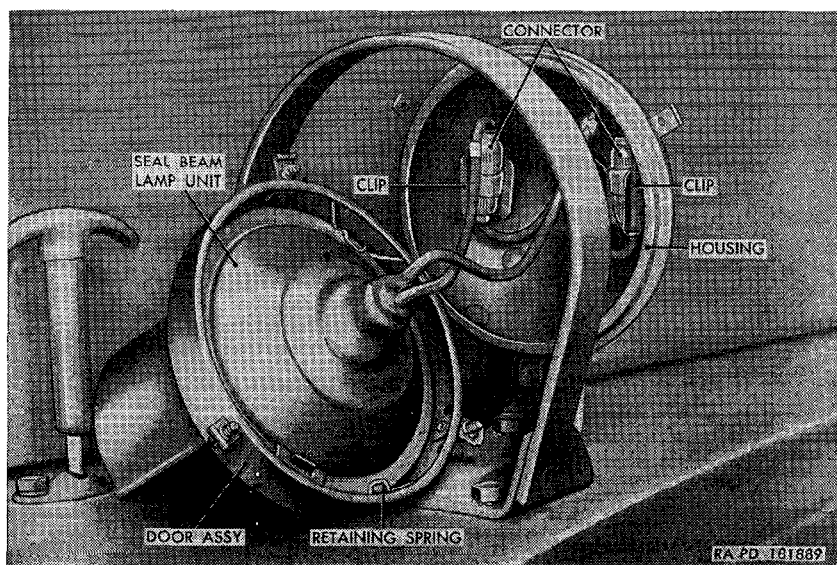

Figure 103. Blackout driving light-lamp-unit assembly withdrawn from housing.

- (b) Pull the cable connectors free from the clips on the housing and disconnect the cable Nos. 19 and 91 connectors, and remove door and lamp-unit.
  - (c) Remove the three lamp-unit retaining springs (fig. 103) from the door, and remove the lamp-unit.
- #### (2) *Installation.*
- (a) Position the lamp-unit with cables in the door, making sure the metal locating tab on the unit is engaged in the door slot. Install the three lamp-unit retaining springs.
  - (b) Position the door and lamp-unit at the housing and connect the cable 19 and 91 connectors. Push the connectors into the clips in the housing.
  - (c) Position the door and lamp unit on the housing and align the door bolts (fig. 104) with the housing mounting holes. Start the bolts into the mounting holes and tighten equally.

*b. Driving Light Assembly Removal.*

- (1) Follow procedure in *a*(1) above.
- (2) Pull the cable assembly and the grommet out of the housing.
- (3) Remove the nut, lockwasher, and washer securing the blackout driving light assembly to the blackout driving light guard, and remove the light from the vehicle.

*c. Driving Light Assembly Installation.*

- (1) Position the blackout driving light assembly in the blackout driving light guard and secure the light with a washer,  $\frac{3}{8}$ -inch lockwasher, and  $\frac{3}{8}$ -inch nut.

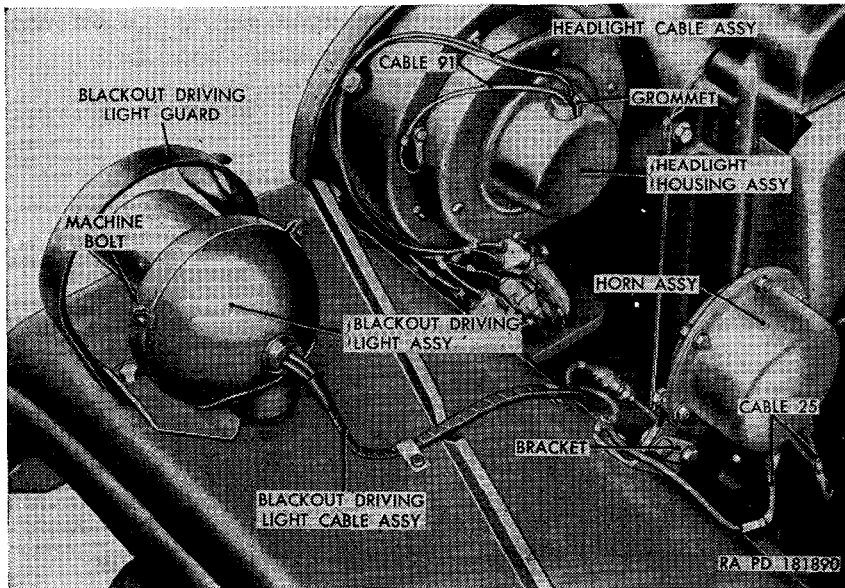

Figure 104. Headlight, blackout driving light, and horn assemblies—installed.

- (2) Push the cable assembly through the housing hole and install the grommet on the cable and in the housing.
- (3) Follow procedure in *a*(2) above.

## 165. Signal Blackout Marker and Service Parking Lights

*a. Lamp Replacement.*

- (1) Remove the two bolts securing the door with lens assembly of the signal blackout marker and service parking light (fig. 102) and remove the door and the door gasket (fig. 105).
- (2) Reach into light assembly and turn lamp counterclockwise and remove lamp.
- (3) Insert new lamp into lamp socket and turn clockwise to lock lamp in position.

- (4) Position door with lens assembly and door gasket on signal blackout marker and service parking light assembly and secure door to light with two No. 8 x 1/2 bolts.
- b. *Light Assembly Removal.*
- (1) Disconnect signal blackout marker and service parking light assembly cable 20 (fig. 182) from wiring harness cable 20 clipped to radiator guard assembly side.
  - (2) Remove the lockwasher nut securing the light to its mounting bracket welded to the radiator guard, and remove light and mounting pad from vehicle.

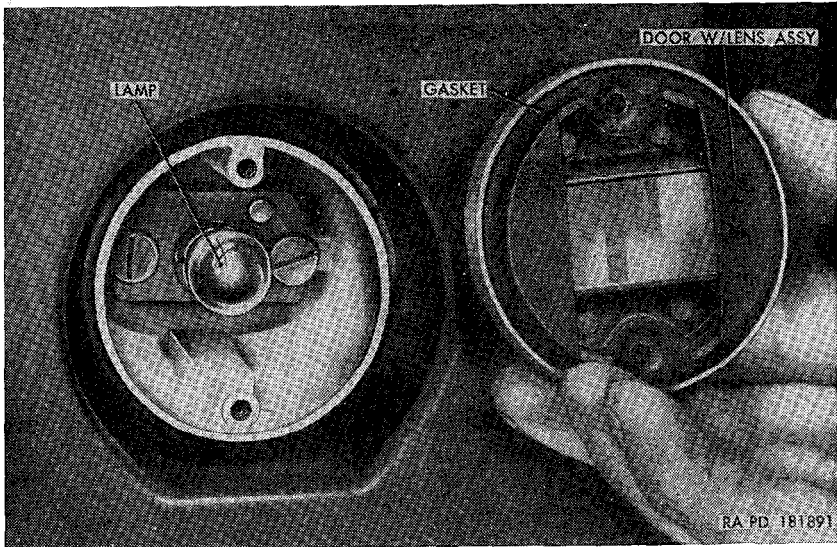

Figure 105. Signal blackout marker and service parking light assembly—door removed.

c. *Light Assembly Installation.*

- (1) Position mounting pad on mounting stud of signal blackout marker and service parking light assembly. Insert light assembly stud through mounting bracket hole welded to radiator guard assembly. Secure in position with a 5/16-inch lockwasher nut.
- (2) Connect connector end of light cable 20 (fig. 182) to connector end of wiring harness cable 20 clipped to radiator guard side.

## 166. Blackout Tail and Stop Light Assembly

(fig. 106)

a. *Lamp Replacement.*

- (1) Loosen the six door with lens assembly screws and remove the door from the housing.

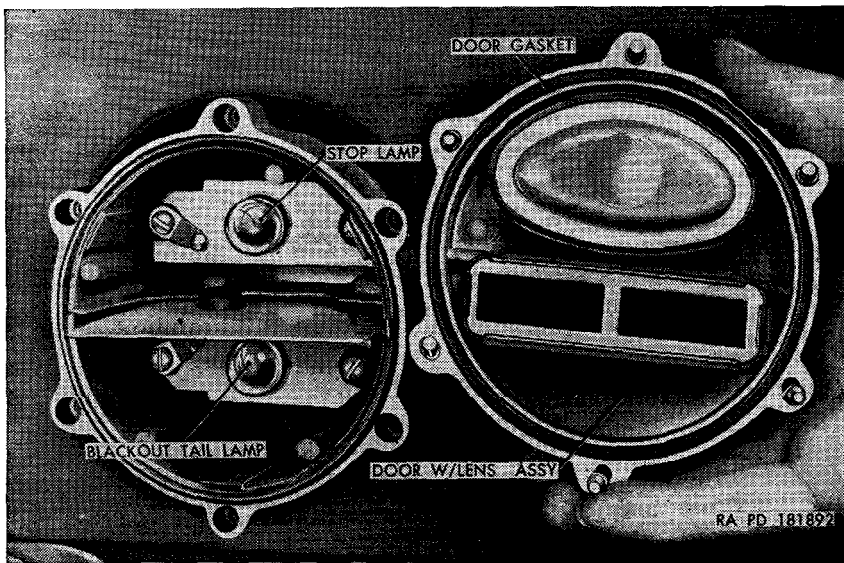

Figure 106. Blackout tail and stop light assembly—installed—door removed.

- (2) Press in on faulty lamp and turn counterclockwise to disengage it from lamp socket.
- (3) Press new lamp into socket and turn clockwise to lock it in position.
- (4) Install the door with lens assembly on the housing and start the six door screws into their housing mounting holes. Tighten the screws uniformly.

*b. Light Assembly removal.*

- (1) Working from underneath vehicle at rear of right wheel house, disconnect cable connectors of cables 24 and 25. Pull light cables out of clip secured to upper portion of mounting bracket welded to vehicle body.
- (2) Remove the two lockwasher bolts securing light to mounting bracket and, working from rear of vehicle, pull light out of body.

*c. Light Assembly installation.*

- (1) Position blackout tail and stop light assembly in rear of right wheel house and insert cables 24 and 25 through hole in mounting bracket welded to vehicle body. Aline housing mounting holes with bracket mounting holes.
- (2) Working from underneath vehicle in right wheel house, insert the two  $\frac{3}{8}$  x  $\frac{5}{8}$  lockwasher bolts through the rear of mounting bracket and into housing mounting holes. Tighten bolts uniformly.
- (3) Connect the connectors of cables 24 and 25. Secure cables in clip attached to upper portion of mounting bracket.

## 167. Service Tail and Stop Light Assembly

### a. Lamp Replacement (fig. 107).

- (1) Remove door with lens assembly (par. 166a(1)).
- (2) Press in on faulty lamp and turn counterclockwise to disengage it from lamp socket.
- (3) Press new lamp into socket and turn clockwise to lock it in position.
- (4) Install door with lens assembly (par. 166a(4)).

### b. Removal (fig. 108).

- (1) Remove the four lockwasher screws in the passenger compartment securing the service tail and stop light and the trailer coupling electrical connector receptacle guard to the body. Two of the screws are located on the top of the wheel house and two are located on the body side panel of the wheel house.
- (2) Remove the lockwasher screw securing the guard to the bracket welded to the inner side of the wheel house outer panel, and remove the guard.
- (3) Working from underneath the vehicle, remove the two lockwasher bolts securing the service tail and stop light assembly to mounting bracket welded to the body.
- (4) Working from rear of vehicle, pull light out of body and disconnect cables 21, 22, and 24 tail and stop light connectors. Remove light from vehicle.

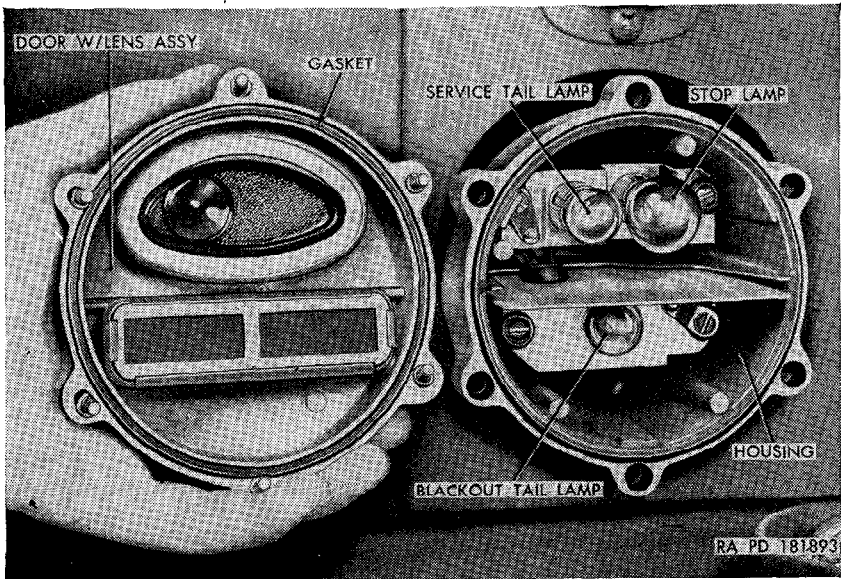

Figure 107. Service tail and stop light assembly—installed—door removed.



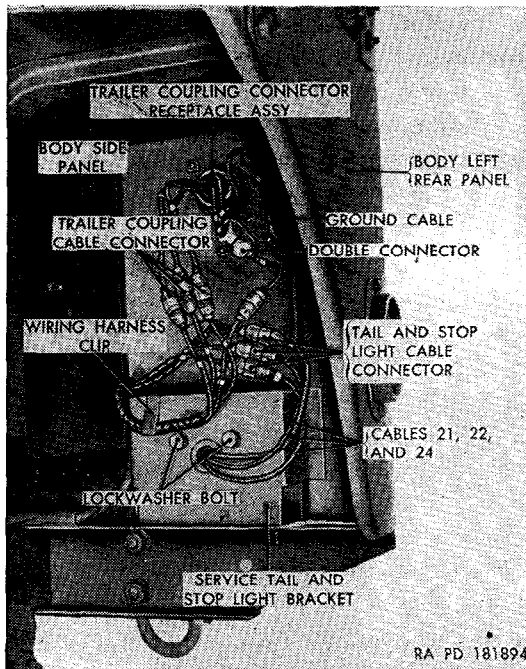

Figure 108. Trailer coupling electrical connector receptacle and service tail and stop light assemblies (M38A1)—disconnect points in wheel house—guard removed.

### c. Installation.

- (1) Position service tail and stop light assembly at vehicle body and connect cables 21, 22, and 24 connectors.
- (2) Position light in vehicle body and align mounting holes in bracket welded to body.
- (3) Working from underneath vehicle, install two  $\frac{3}{8}$  x  $\frac{5}{8}$  lockwasher bolts through rear of bracket and into mounting holes in the light housing. Tighten bolts uniformly.
- (4) Position the service tail and stop light and the trailer coupling electrical connector receptacle guard in the wheel house.
- (5) Install the four  $\frac{1}{4}$  x  $\frac{5}{8}$  lockwasher screws as located in *b*(1) and (2) above.

## 168. Instrument Panel Lights and Headlight High Beam Indicator Light

The removal, installation, and lamp replacement for the instrument panel lights and high beam indicator lights are contained in paragraphs 179 and 180.

## 169. Trailer Coupling Electrical Connector Receptacle (M38A1)

(fig. 108)

### a. Removal.

- (1) Remove the service tail and stop light and trailer coupling electrical connector receptacle guard from the vehicle body (par. 167b(1) and (2)).
- (2) Disconnect receptacle cables 21, 22, 23, and 24 from wiring harness cables 21, 22, 23, and 24.
- (3) Working from rear of vehicle remove the screw, nut, lockwasher, and internal-external-teeth lockwasher securing cable 90 (ground cable) to vehicle body. The screw is located below the left of the receptacle.
- (4) Remove the four lockwasher screws securing the receptacle to body and remove receptacle from vehicle.

*Note.* When removing receptacle from body, the cover assembly and polarizing bracket are unavoidably detached from receptacle.

### b. Installation.

- (1) Position polarizing bracket and cover assembly on trailer coupling electrical connector receptacle assembly.
- (2) Insert receptacle into its mounting hole in body, aligning mounting holes in bracket, cover, and receptacle with mounting holes in body. Secure receptacle in position with four  $\frac{1}{4} \times \frac{5}{8}$  lockwasher screws.
- (3) Insert a No. 10 x  $\frac{5}{8}$  screw through its hole below and to the left of the receptacle.
- (4) Working in the rear left wheel house, carefully position a No. 10 internal-external-teeth lockwasher, cable 90 (ground cable) of receptacle, No. 10 lockwasher, and No. 10 nut on screw installed in (3) above and tighten.
- (5) Connect receptacle cables 21, 22, 23, and 24 to wiring harness cables 21, 22, 23, and 24.
- (6) Install the service tail and stop light and trailer coupling electrical connector receptacle guard (par. 167c(4)).

## 170. Emergency Reel Lamp Assembly (M170)

(fig. 109)

### a. Lamp Unit Replacement.

- (1) Remove lamp unit by opening lamp unit cover and pressing lamp unit in and turning in a counterclockwise direction.
- (2) Install lamp unit by pressing lamp unit into lamp unit socket and turning in a clockwise direction. Close lamp unit cover.

### b. Light Assembly removal.

- (1) Disconnect the connector on cable 39 and slip cable from retaining clip.

- (2) Remove top lockwasher screw securing emergency reel lamp mounting bracket to mounting pad.
- (3) Remove bottom lockwasher screw, cable 39A bracket, and internal-external-teeth lockwasher, and remove reel assembly.

*c. Light Assembly Installation.*

- (1) Position holes in reel mounting bracket on mounting pad holes on the left side of the driver's seat and start the top  $\frac{1}{4} \times \frac{1}{2}$  lockwasher screw, but do not tighten.
- (2) Aline holes in cable 39A bracket, internal-external-teeth lockwasher, and mounting bracket bottom hole and secure with a  $\frac{1}{4} \times \frac{1}{2}$  lockwasher screw.

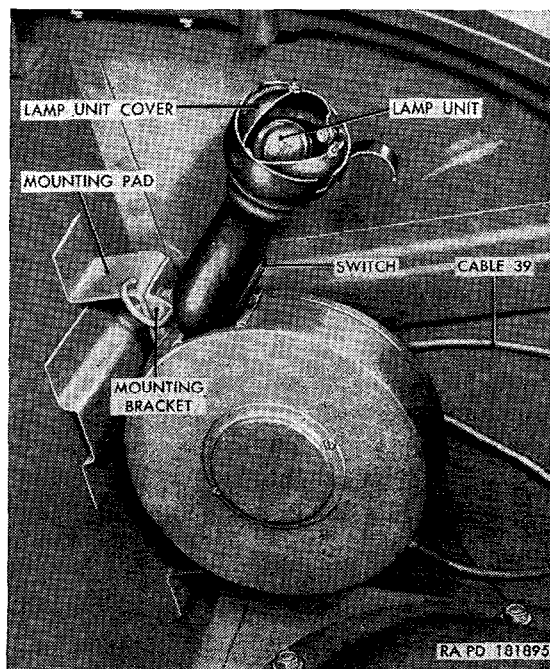
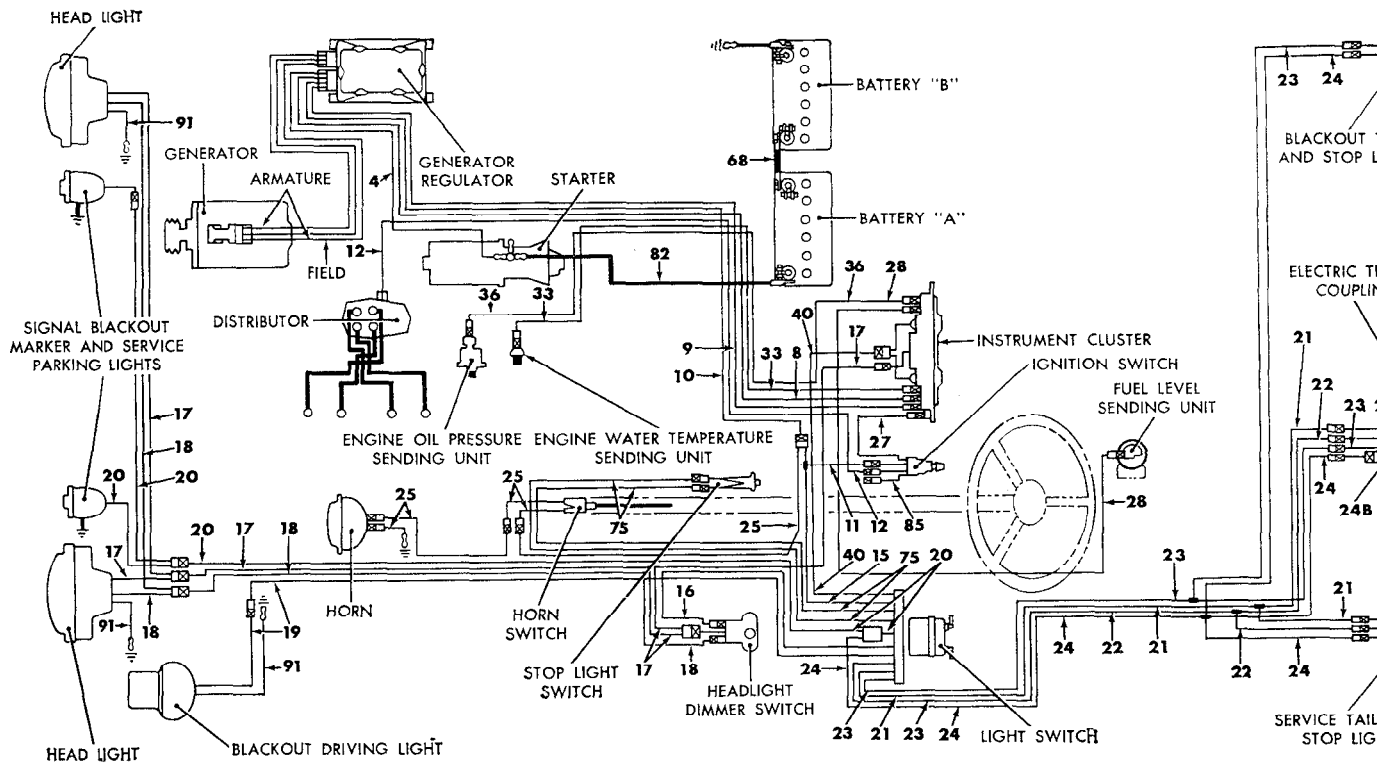

*Figure 109. Emergency reel lamp assembly (M170)—installed.*

- (3) Tighten the mounting bracket top lockwasher screw.
- (4) Connect cable 39 bayonet connector and slip cable behind retaining clip.

## **171. Electrical Components and Cables**

*a. General.* Each electrical cable, with the exception of spark plug cables, is identified by a numbered metal tag at each end of cable. All cables in a single circuit are identified by the same number; however, when cables are connected through more than one connector, they may connect to a different numbered terminal at each connector. Reference should be made to figures 110 or 111 when making cable replacements.



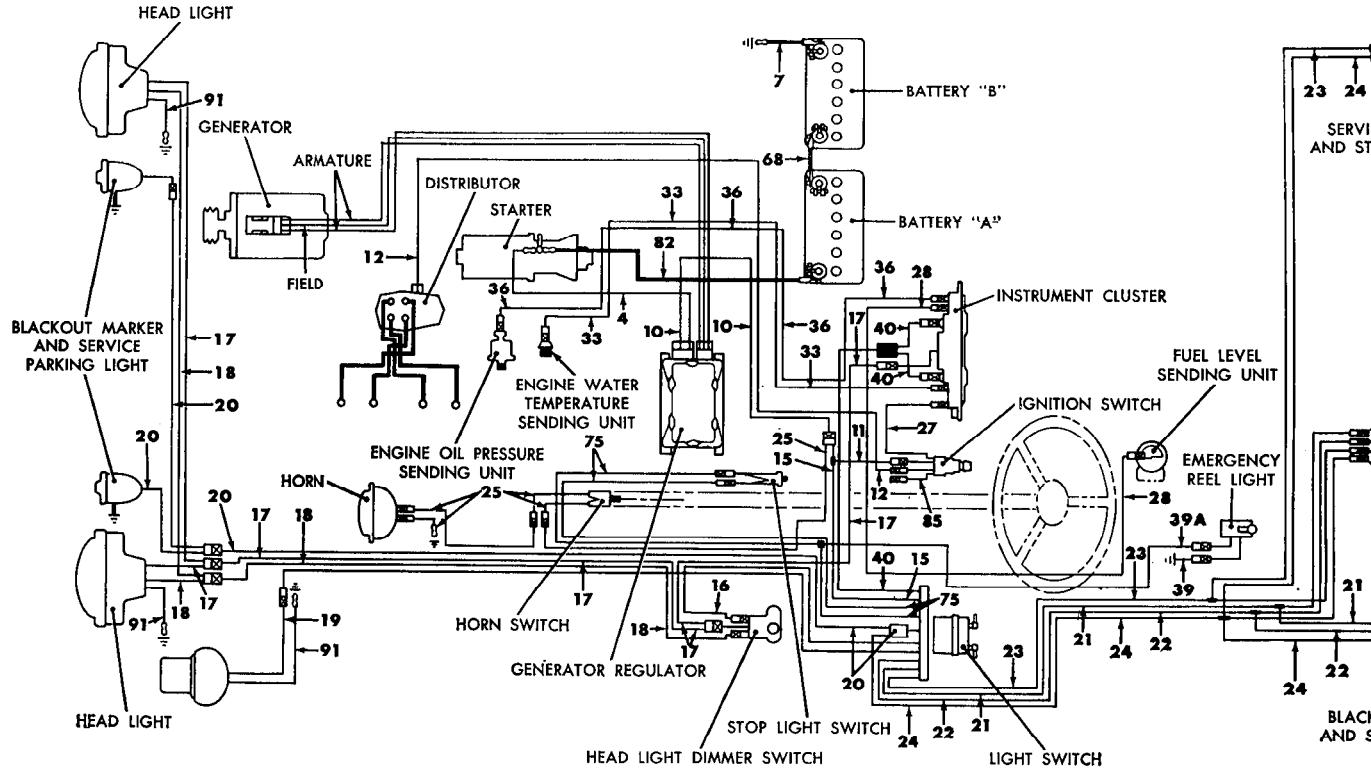

Figure 111. Vehicle electrical components and cable identification (M170).

*b. Circuit Identification.* Table IV lists each circuit number in the electrical system and briefly traces each circuit from its source to its end. A point-to-point check for circuit continuity can be made, using a battery operated test light, conventional 24-volt test light, and voltmeter equipped with long cables and suitable prods.

*Table IV. Circuit Numbers and Descriptions*

Circuit No.	Circuit description
4	Generator regulator output A terminal to starter.
7	Battery "B" to ground.
8	Generator regulator output B terminal to positive ammeter terminal.
9	Generator regulator output D terminal to negative ammeter terminal.
10	Generator regulator output C terminal to horn switch, ignition switch, and light switch connector.
11	Ignition switch to light switch F terminal.
12	Distributor and ignition coil to ignition switch.
15	Generator regulator C terminal to light switch F terminal.
16	Light switch M terminal to dimmer switch.
17	Headlight to dimmer switch and high beam indicator.
18	Headlight to dimmer switch.
19	Light switch D terminal to blackout driving light.
20	Light switch E terminal to signal blackout marker and service parking lights.
21	Light switch H terminal to trailer coupling electrical connector receptacle E terminal and service tail and stop light.
22	Light switch C terminal to trailer coupling electrical connector receptacle B terminal and service tail and stop light.
23	Light switch N terminal to trailer coupling electrical connector receptacle F terminal and blackout tail and stop light and service tail and stop light.
24	Light switch E terminal to trailer coupling electrical connector receptacle H and C terminals and service tail and stop light, and blackout tail and stop light and service tail and stop light.
25	Horn circuit from generator regulator C terminal to horn switch, horn, and horn ground.
27	Instrument panel to ignition switch.
28	Fuel gage to fuel level sending unit.
33	Engine water temperature gage to engine water temperature sending unit.
36	Engine oil pressure gage to engine oil pressure sending unit.
39	Light switch to emergency reel lamp assembly.
39A	Emergency reel lamp assembly to ground.
40	Light switch B terminal to instrument panel lights.
68	Battery "A" to Battery "B".
75	Light switch A and K terminals to stoplight switch Battery "A" to starter.
82	Battery "A" to starter.
90	Trailer coupling electrical connector receptacle to ground.
91	Blackout driving light and headlights to ground.

*Note.* Circuits 21, 22, 23, 24, and 90 do not include a trailer coupling electrical connector on the M170. Circuits 39 and 39A are not included on the M38A1.

## Section XIV. INSTRUMENT CLUSTER, INSTRUMENTS, GAGES, SWITCHES, SENDING UNITS, AND HORN

### 172. General

*a. Instrument Cluster* (figs. 112 and 113). The speedometer, ammeter, engine oil pressure gage, water temperature gage, fuel level gage, two instrument panel lights, and headlight high beam indicator light are mounted in the instrument panel mounting plate located in the instrument panel. This assembly is referred to as the instrument cluster. The location and function of the various units in the instrument cluster are described in paragraphs 33 through 39.

*b. Switches.* The location and function of the various switches, except for the stoplight switch, are described in paragraphs 23, 24, and 25. The stoplight switch is attached to the front of the brake master cylinder, and is hydraulically operated by the action of the service brake pedal.

*c. Sending Units.*

(1) *Engine water temperature sending unit* (fig. 120). The engine water temperature sending unit, mounted on the right side of the cylinder head, electrically transmits the water temperature to the water temperature gage through cable 33.

(2) *Engine oil pressure sending unit* (fig. 120). The engine oil pressure sending unit, mounted on the right side of the cylinder block, electrically transmits the engine oil pressure to the oil pressure gage through cable 36.

(3) *Fuel level sending unit* (figs. 69 and 70). The fuel tank level sending unit, mounted in the top section of the fuel tank, electrically transmits the fuel level in the tank to the fuel gage through cable 28.

*d. Horn* (fig. 104). The horn is of the vibrator-type, electrically operated, and fully waterproofed. It is mounted underneath the hood and attached to the left front fender by a mounting bracket. The horn is connected to the horn switch by the two cables 25.

*e. Cable Numbers.* Standard circuit or cable numbers are used throughout. These cable numbers are stamped on small metal tags attached near the ends of each cable. These numbers are shown in figure 110.

### 173. Instrument Cluster

*Note.* The key letters noted in parentheses refer to figure 114, except where otherwise indicated.

*a. Removal.* Disconnect the ground cable 7 (par. 162b(8) (a) and (b)). Turn each of the four instrument cluster mounting plate studs (A, fig. 112) one-half turn counterclockwise and pull instrument cluster free from instrument panel. Unscrew the nut securing the

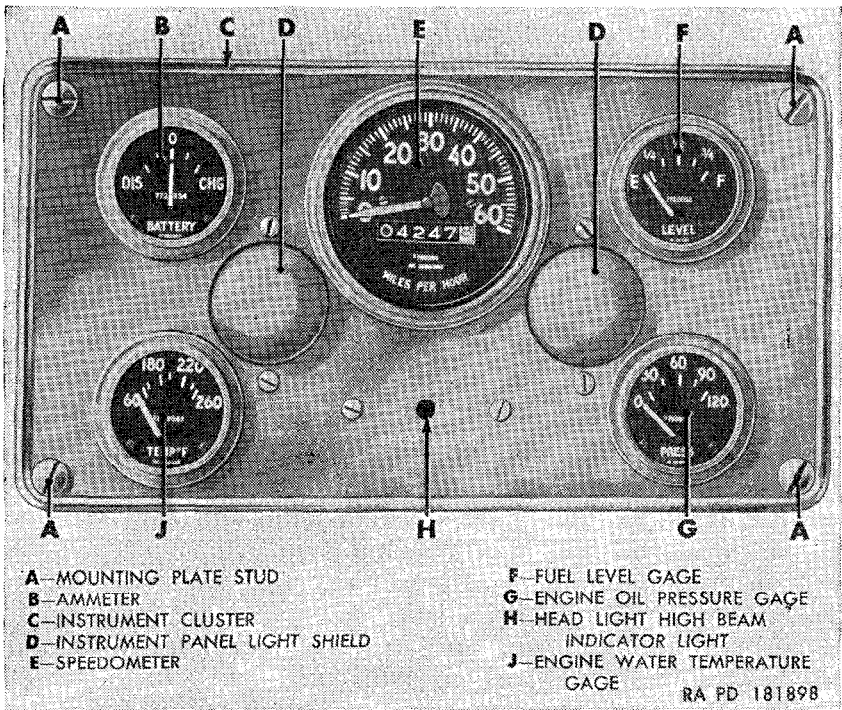

Figure 112. Instrument cluster (M38A1)—front view.

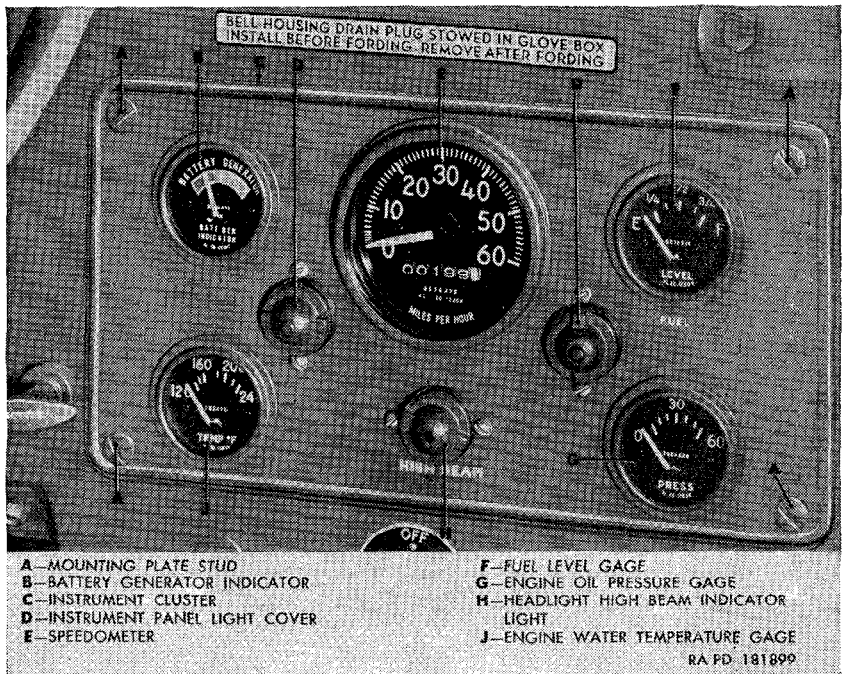

Figure 113. Instrument cluster (M170)—front view.





Figure 114. Instrument cluster (M38A1)—rear view.

speedometer flexible shaft assembly to the speedometer (DD) and pull shaft from speedometer. Disconnect cable 27 at connector (T), from instrument cluster circuit breaker-to-gages wiring harness (AA). Disconnect cable 17 at connector (U). Disconnect cable 40 at double connector (R). Disconnect cables 8 and 9 at terminals (H and L). Disconnect cable 33 at terminal (M). Disconnect cable 36 at terminal (W). Disconnect cable 28 at terminal (A). Remove instrument cluster from instrument panel.

*b. Installation.* Position the instrument cluster at instrument panel so cables may be connected. Connect cable 36 at terminal W, and cable 33 at terminal M. Connect cable 28 at terminal A. Connect cable 8 at terminal H and cable 9 at terminal L. Connect cable

40 at double connector R. Connect cable 17 at connector U. Connect cable 27 to connector T. Position speedometer flexible shaft assembly in rear of speedometer and tighten nut securing shaft to speedometer (DD). Install instrument cluster in instrument panel and secure in position by turning the four instrument cluster mounting plate studs (A, fig. 112) one-half turn clockwise. Connect ground cable 7 (par. 162b(9)(b) and (c)).

#### 174. Ammeter (M38A1) and Battery Generator Indicator (M170)

##### a. Ammeter Removal (M38A1).

*Note.* The key letters noted in parentheses refer to figure 114, except where otherwise indicated.

Disconnect ground cable 7 (par. 162b(8)(a) and (b)). Turn the four instrument cluster mounting plate studs (A, fig. 112) one-half

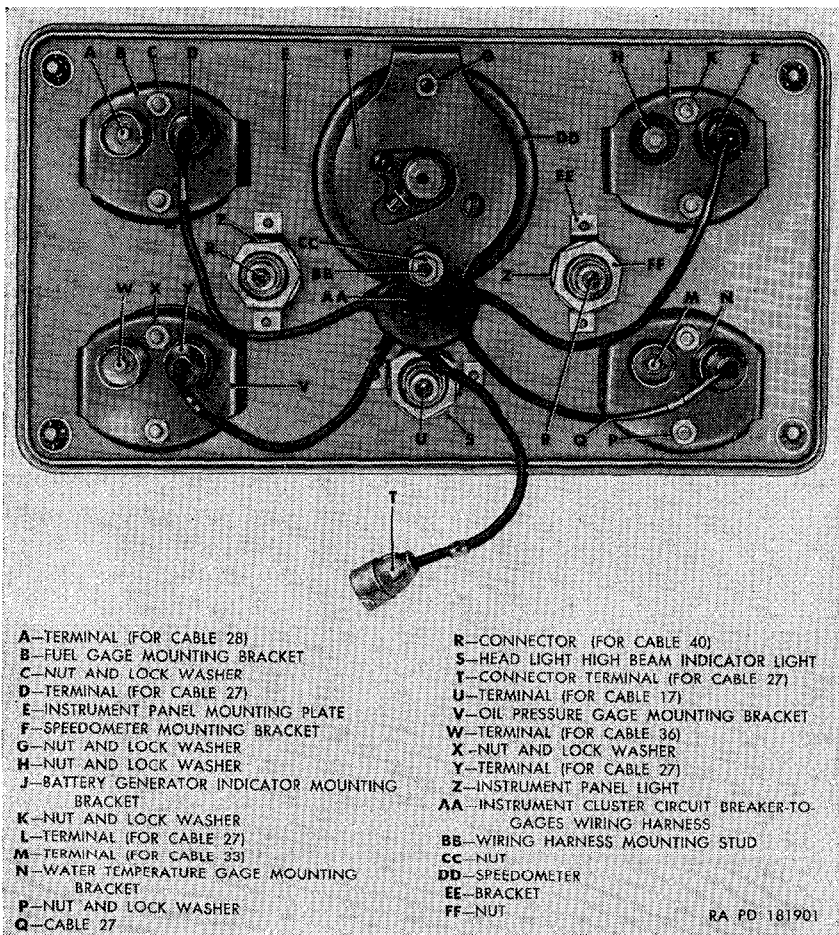

Figure 115. Instrument cluster (M170)—rear view.

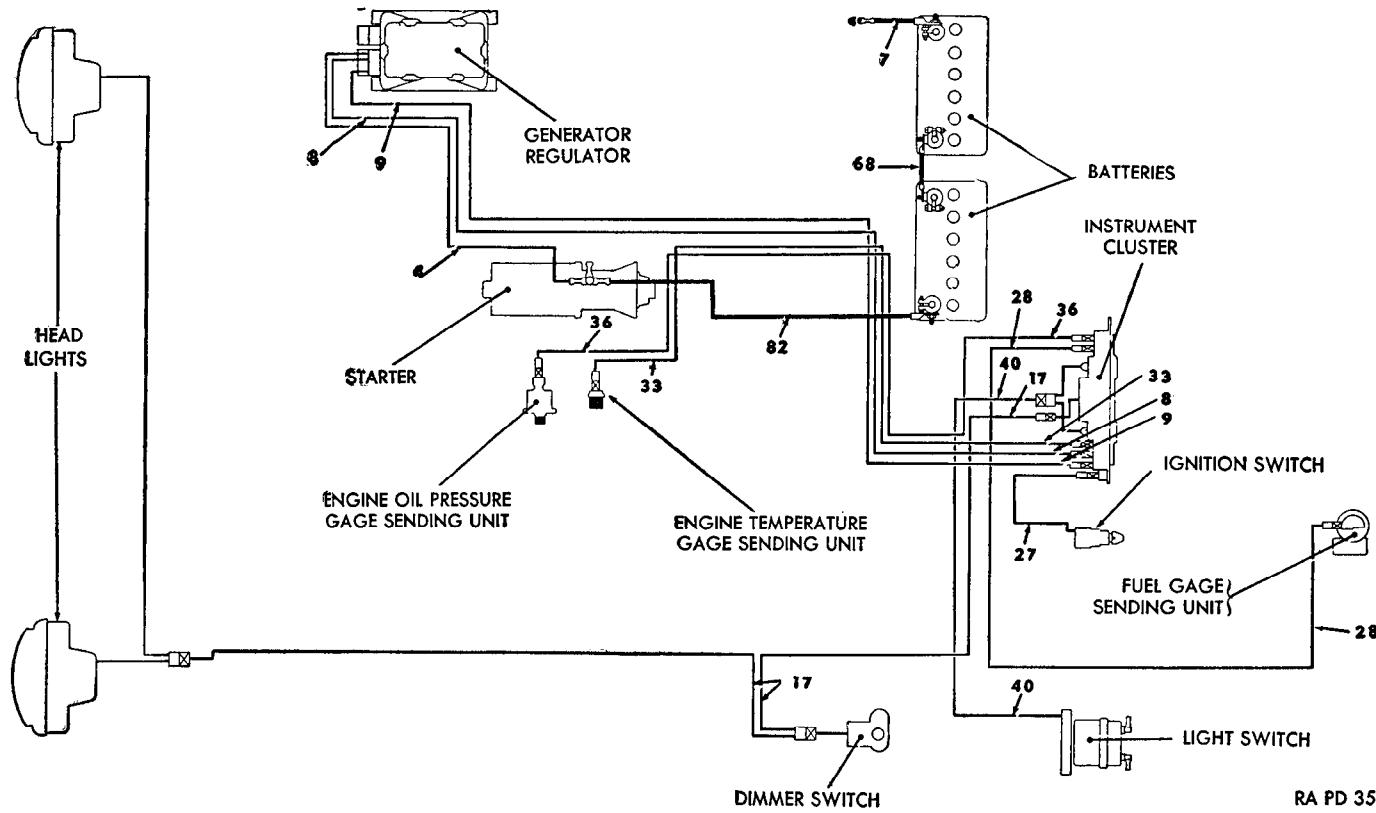
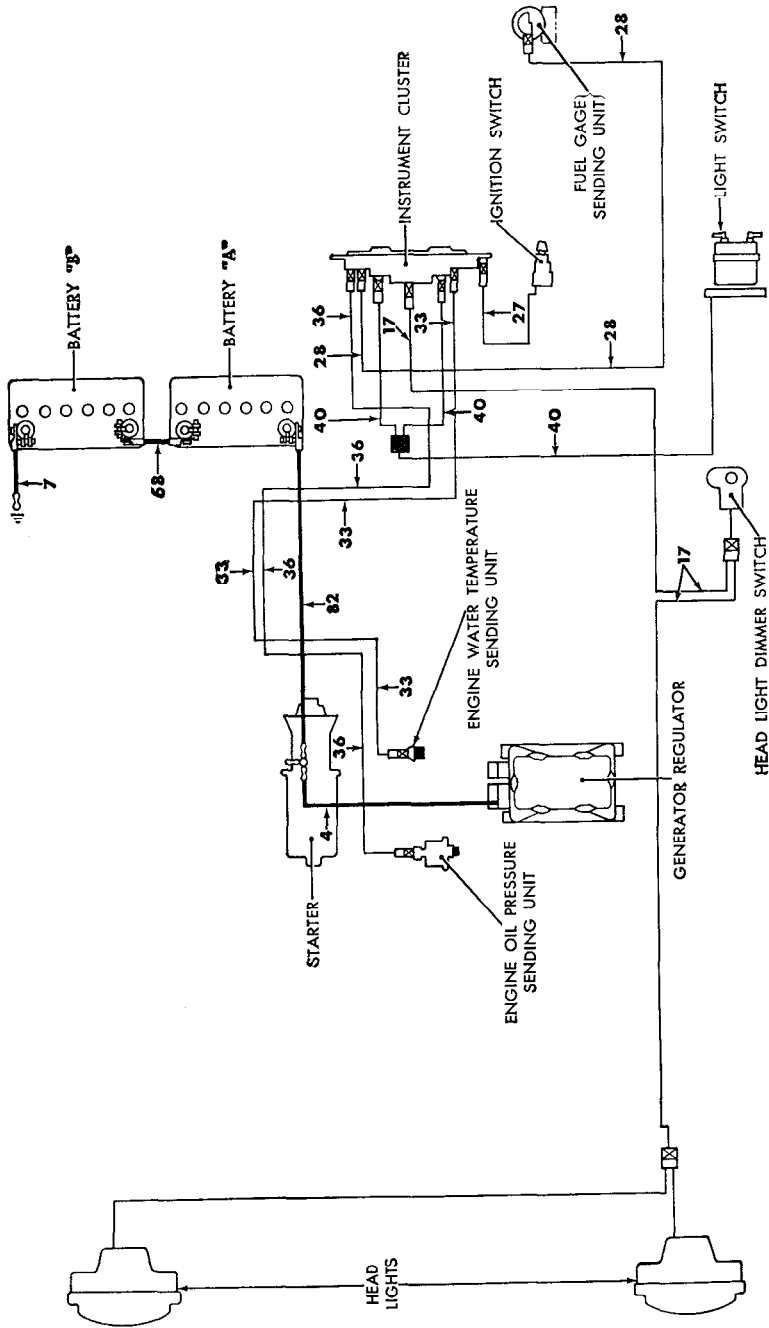

Figure 116. Instruments, gages, switches, and sending units wiring diagram (M38A1).



RAPD 181902

Figure 117. Instruments, gages, switches, and sending units wiring diagram (MITO).

turn counterclockwise and pull instrument cluster free from instrument panel. Disconnect cables 8 and 9 from terminals H and L. Remove the nuts and lockwashers (K) securing the ammeter (B, fig. 112) and ammeter mounting bracket (J) in position and remove bracket and ammeter from instrument panel mounting plate (E).

*b. Ammeter Installation (M38A1).*

*Note.* The key letters noted in parentheses refer to figure 114, except where otherwise indicated.

Position the ammeter in the instrument panel mounting plate (E) and rotate ammeter until it engages the locating slot in the plate. Position ammeter mounting bracket (J) over the ammeter and secure ammeter and bracket in position with two No. 8 lockwashers and nuts (K). Install cable 8 on terminal H and cable 9 on terminal L. Position the instrument cluster on the instrument panel and turn the four instrument cluster mounting plate studs (A, fig. 112) one-half turn clockwise. Connect ground cable 7 (par. 162b(9)(b) and (c)).

*c. Battery Generator Indicator Removal (M170).*

*Note.* The key letters noted in parentheses refer to figure 115, except where otherwise indicated.

Disconnect the ground cable 7 (par. 162b(8)(a) and (b)). Turn the four instrument mounting plate studs (A, fig. 113) one-half turn counterclockwise and pull instrument cluster free from instrument panel. Disconnect cable 27 from terminal L. Remove the two nuts and lockwashers (K) securing the battery generator indicator (B, fig. 113) and the battery generator indicator mounting bracket (J), and remove indicator and bracket from instrument panel mounting plate (E).

*d. Battery Generator Indicator Installation (M170).*

*Note.* The key letters noted in parentheses refer to figure 115, except where otherwise indicated.

Position the battery generator indicator (B, fig. 113) in the instrument panel mounting plate (E) and rotate indicator until it engages the locating slot in plate. Install the battery generator indicator mounting bracket (J) over the indicator and secure the indicator and bracket to the instrument panel mounting plate (E) with two No. 8 lockwashers and nuts (K). Connect cable 27 to terminal L. Position the instrument cluster on the instrument panel and turn the four instrument cluster mounting plate studs (A, fig. 113) one-half turn clockwise. Connect ground cable 7 (par. 162b(9)(b) and (c)).

## 175. Fuel Gage

*a. Removal.* The removal procedure for the fuel level gage (F, fig. 112) is the same as the removal procedure for the ammeter (par. 174a) with the exception of the mounting bracket and the cables.

Fuel gage mounting bracket (B, fig. 114) is used. Disconnect cables 27 and 28 from terminals (D and A, fig. 114).

*b. Installation.* The installation procedure for the fuel level gage (F, fig. 112) is the same as installation procedure for the ammeter (par. 174*b*) with the exception of mounting bracket and cables. The fuel gage mounting bracket (B, fig. 114) is used. Install cable 28 on terminal (A, fig. 114) and cable 27 on terminal (D, fig. 114).

### **176. Engine Water Temperature Gage**

*a. Removal.* The removal procedure for the engine water temperature gage (J, fig. 112) is the same as the removal procedure for the ammeter (par. 174*a*) with the exception of the mounting bracket and the cables. Water temperature gage mounting bracket (N, fig. 114) is used. Disconnect cable 27 from terminal (Q, fig. 114) and cable 33 from terminal (M, fig. 114).

*b. Installation.* The installation procedure for the engine water temperature gage is the same as the installation procedure for the ammeter (par. 174*b*) with the exception of the mounting bracket and the cables. Water temperature gage mounting bracket (N, fig. 114) is used. Connect cable 33 to terminal (M, fig. 114) and cable 27 to terminal (Q, fig. 114).

### **177. Engine Oil Pressure Gage**

*a. Removal.* The removal procedure for the engine oil pressure gage (G, fig. 112) is the same as removal procedure for the ammeter (par. 174*a*) except for the mounting bracket and cables. Oil pressure gage mounting bracket (V, fig. 114) is used. Disconnect cable 27 from terminal (Y, fig. 114) and cable 36 from terminal (W, fig. 114).

*b. Installation.* Installation of the engine oil pressure gage (G, fig. 112) is the same as installation of the ammeter (par. 174*b*) with the exception of the mounting bracket and cables. Oil pressure gage mounting bracket (V, fig. 114) is used. Install cable 36 on terminal (W, fig. 114) and cable 27 on terminal (Y, fig. 114).

### **178. Speedometer**

*Note.* The key letters noted in parentheses refer to figure 114, except where otherwise indicated.

*a. Removal.*

- (1) Turn the four instrument cluster mounting plate studs (A, fig. 112) one-half turn counterclockwise and pull the instrument cluster free from instrument panel.
- (2) Unscrew the nut securing the speedometer flexible shaft assembly to the speedometer (DD), and pull shaft out of speedometer.
- (3) Remove the nut (CC), lockwasher, and plain washer securing the instrument cluster circuit breaker-to-gages wiring harness

(AA) to the wiring harness mounting stud (BB) and detach harness from stud.

- (4) Remove plain washer, wiring harness mounting stud, and lockwasher from the speedometer mounting stud.
- (5) Remove the nut and lockwasher (G) from the remaining speedometer mounting stud and remove speedometer mounting bracket (F) and speedometer (DD) from instrument panel mounting plate (E).

*b. Installation.*

- (1) Position the speedometer (DD) in the instrument panel mounting plate (E) and locate speedometer mounting bracket (F) over speedometer mounting studs.
- (2) Install a No. 8 lockwasher on speedometer lower mounting stud, and screw the wiring harness mounting stud (BB) on the speedometer mounting stud.
- (3) Install the 0.322-inch ID plain washer, instrument cluster circuit breaker-to-gages wiring harness (AA), 0.203-inch ID plain washer, and No. 8 nut (CC) on the wiring harness mounting stud. Install a No. 8 lockwasher and nut (G) on the remaining speedometer mounting stud.
- (4) Install the speedometer flexible shaft assembly in the speedometer (DD) and tighten nut securely.
- (5) Position instrument cluster on instrument panel and turn the four instrument cluster mounting plate studs (A, fig. 112) one-half turn clockwise.

*c. Speedometer Flexible Shaft Core Replacement.* Disconnect the speedometer at the instrument cluster (a(1) and (2) above). Using long nosed pliers, pull the core out of the speedometer casing. If the core is broken, unscrew the nut (K, fig. 57) from the speedometer driven gear sleeve on the transfer. Remove the lower end of the casing from the sleeve and pull out the broken part of the core. Push a new flexible shaft core into the upper end of the casing far enough to seat. Position the lower end of the flexible shaft core in the speedometer driven gear sleeve and secure the casing to the sleeve with nut (K, fig. 57). Install the speedometer at the instrument cluster (b(4) and (5) above).

## 179. Instrument Panel Lights

*Note.* The key letters noted in parentheses refer to figure 114, except where otherwise indicated.

*a. Removal (M38A1).* Turn the four instrument cluster mounting plate studs (A, fig. 112) one-half turn counterclockwise and pull instrument cluster free from instrument panel. The two instrument panel lights with cables are permanently connected together in double connector (R) and must be replaced as one unit. Disconnect cable 40

at double connector (R). Remove the four screws and lockwashers securing the instrument panel lights (Z) to the instrument panel mounting plate (E) and remove lights and instrument panel light shields (D, fig. 112).

*b. Installation (M38A1).* Position the instrument panel light shields (D, fig. 112) in the instrument panel mounting plate (E). Position the two instrument panel lights on the plate and secure each one with two No. 8 x  $\frac{5}{16}$  screws and No. 8 lockwashers. Connect cable 40 to double connector R. Position instrument cluster on instrument panel and turn the four instrument cluster mounting plate studs (A, fig. 112) one-half turn clockwise.

*c. Removal (M170).* Turn the four instrument cluster mounting plate studs (A, fig. 113) one-half turn counterclockwise and pull instrument cluster free from instrument panel. Unscrew the instrument panel light cover (D, fig. 113) from the instrument panel light (Z, fig. 115). Disconnect cable 40 from connector (R, fig. 115). Unscrew the nut (FF, fig. 115) and remove the lockwasher securing the instrument panel light (Z, fig. 115) to the bracket (EE, fig. 115) and push light out of bracket from the rear of the panel and through the opening in the panel.

*d. Installation (M170).* Insert the instrument panel light into the bracket (EE, fig. 115) through the opening in the instrument cluster panel. Place a lockwasher over the threaded end of the light and install the nut (FF, fig. 115) securing the light to the bracket (EE, fig. 115). Connect cable 40 to the connector (R, fig. 115). Screw the cover (D, fig. 113) onto the instrument panel light (Z, fig. 115). Position the instrument cluster on the instrument panel and turn the four instrument cluster mounting plate studs (A, fig. 113) one-half turn clockwise.

*e. Lamp Replacement (M38A1).* Turn the four instrument cluster mounting plate studs (A, fig. 112) one-half turn counterclockwise and pull instrument cluster free from instrument panel. Press in on the cover of the instrument panel light (Z), turn counterclockwise and pull cover off light body. Press in and turn lamp counterclockwise, to disengage it from lamp socket and remove lamp. Install new lamp by pressing lamp into socket and turning clockwise. Install instrument panel light cover by pressing in and turning clockwise in lamp body. Position instrument cluster on instrument panel and turn the four instrument cluster mounting plate studs (A, fig. 112) one-half turn clockwise.

*f. Lamp Replacement (M170).* Screw the instrument panel light cover (D, fig. 113) counterclockwise and remove. Press in and turn lamp counterclockwise to disengage. Install new lamp by pressing lamp into socket and turning clockwise. Install instrument panel light cover.



## 180. Headlight High Beam Indicator Lights

*a. Removal (M38A1).* Turn the four instrument cluster mounting plate studs (A, fig. 112) one-half turn counterclockwise and pull instrument cluster free from instrument panel. Disconnect cable 17 at connector (U, fig. 114). Remove the two screws and lockwashers securing the headlight high beam indicator light in position and remove indicator light.

*b. Installation (M38A1).* Position the headlight high beam indicator light (S, fig. 114) on the instrument panel mounting plate (E, fig. 114) and secure in position with two No. 8 x 1/2 screws and No. 8 lockwashers. Connect cable 17 to connector (U, fig. 114). Position instrument cluster on instrument panel and turn the four instrument cluster mounting plate studs (A, fig. 112) one-half turn clockwise.

*c. Removal (M170).* Follow the same procedure as outlined in paragraph 179b(1) for instrument panel lights except that cable 17 is disconnected from connector (T, fig. 115).

*d. Installation (M170).* Follow the same procedure as outlined in paragraph 179b(2) for instrument panel lights except that cable 17 is connected to the connector (T, fig. 115).

*e. Lamp Replacement (M38A1).* Turn the four instrument cluster mounting plate studs (A, fig. 112) one-half turn counterclockwise and pull instrument cluster free from instrument panel. Turn the cover of the headlight high beam indicator light (S, fig. 114) counterclockwise and pull cover out of light body. Press in and turn lamp counterclockwise to disengage it from lamp socket. Install new lamp by pressing it into lamp socket and rotating clockwise. Position indicator light cover on light body, press in and turn cover clockwise to engage with light body. Position instrument cluster on instrument panel and turn the four instrument cluster mounting plate studs (A, fig. 112) one-half turn clockwise.

*f. Lamp Replacement (M170).* Screw the instrument panel light cover (D, fig. 113) counterclockwise and remove. Press in and turn lamp counterclockwise to disengage. Install new lamp by pressing lamp into socket and turning clockwise. Install headlight high beam indicator light cover.

## 181. Ignition Switch

*a. Removal.* Disconnect ground cable 7 from battery "B" (par. 162b(8)(a) and (b)). Remove bolt and lockwasher securing and ignition switch lever to the ignition switch (H, fig. 13) and pull lever off switch. Remove the plain nut and lockwasher securing the ignition switch in position and push switch out of instrument panel. Disconnect connector on cables 11, 12, and 27. Remove switch from face of instrument panel.

*b. Installation.* Position switch in instrument panel and connect connectors on cables 11, 12, and 27 (fig. 96). Secure ignition switch in position with a 1/2-inch lockwasher and plain nut. Position ignition switch lever on the ignition switch and secure with a No. 8 lockwasher and No. 8 x 3/8 bolt. Connect ground cable 7 (par. 162*b*(9)(*b*) and (*c*)) to battery "B."

## 182. Light Switch

(fig. 15)

*a. Removal.* Remove the bolt and internal-teeth lockwasher securing the main switch lever in position and remove switch lever and

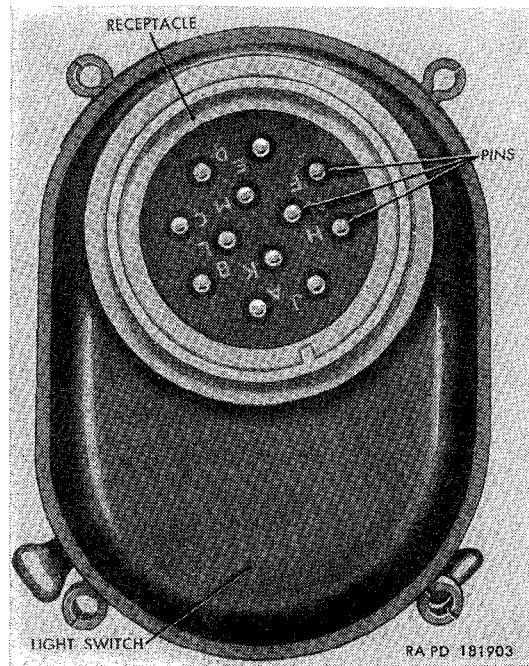

Figure 118. Light switch—reverse side.

flat washer. Remove the four lockwasher screws securing light switch to the instrumental panel. Push in on light switch and, at the same time, tilt down so the mechanical switch lever and auxiliary switch lever enter opening in instrument panel and pull switch out from reverse side of instrument panel. Disconnect the cable plug from the switch receptacle and remove switch.

*b. Installation.* Position light switch in instrument panel and secure with four No. 10 x 1/2 pan-head lockwasher screws. Connect cable plug to receptacle in light switch. Make sure the felt washer is installed on the main switch lever shaft. Install a 3/8-inch flat washer on the shaft against the felt washer. Install main switch

lever on shaft and secure in position with a No. 8 internal-teeth lockwasher and No. 8 x  $\frac{5}{8}$  bolt.

### 183. Headlight Dimmer Switch

(fig. 119)

*a. Removal.* Disconnect double connector on cable 17. Disconnect connectors on cables 16 and 18. Remove the two lockwasher screws securing switch in position and remove switch.

*b. Installation.* Position headlight dimmer switch in the front floor pan and secure with two  $\frac{1}{4}$  x  $\frac{1}{2}$  lockwasher screws. Connect cables 16 and 18 to connectors on switch. Connect cable 17 at double connector.

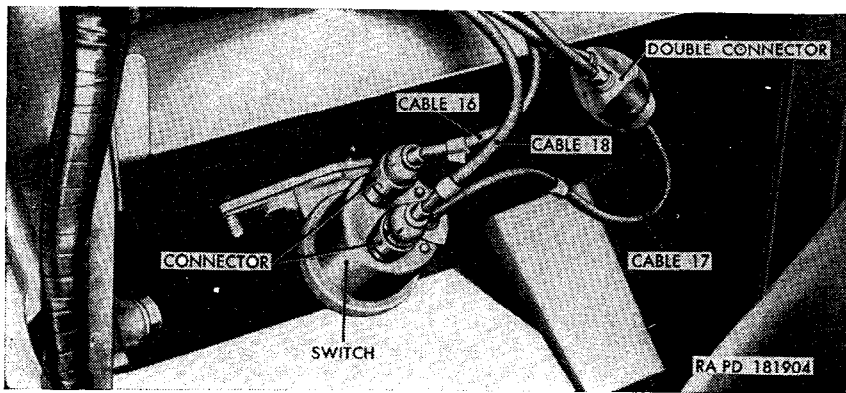

Figure 119. Headlight dimmer switch—installed.

### 184. Horn

(fig. 105)

*a. Removal.* Disconnect the two cables 25 at the connectors on the horn. Remove the two lockwasher bolts securing the horn bracket to fender and remove horn and horn bracket. To remove the horn independently from the bracket, disconnect the two cables 25 from the connectors on the horn. Remove the two plain nuts, four lockwashers, and two bolts securing the horn to bracket and remove horn and name plate.

*b. Installation.* Position horn and horn bracket on fender and secure in position with two  $\frac{1}{4}$  x  $\frac{5}{8}$  lockwasher bolts. Connect cables 25 to connectors on horn. To install horn on horn bracket, install a  $\frac{1}{4}$ -inch lockwasher on a  $\frac{1}{4}$  x  $\frac{3}{4}$  bolt. Position horn name plate on horn bracket alining the mounting holes in the plate with mounting holes in bracket, and insert bolt through name plate and bracket. Position horn at horn bracket, alining the mounting holes in the horn with the mounting holes in the bracket, and thread the bolt into the horn. Install a  $\frac{1}{4}$ -inch lockwasher on a  $\frac{1}{4}$  x  $\frac{3}{4}$  bolt and insert bolt

through the remaining mounting hole in the name plate and bracket and thread into horn. Tighten the two bolts; then secure with two ¼-inch lockwashers and plain nuts. Connect the two cables 25 to the connectors on the horn.

### **185. Horn Switch**

*a. Removal.* Disconnect the two cables 25 at the connectors (H, fig. 161). Unscrew the switch from bottom of steering gear.

*b. Installation.* Screw horn switch into bottom of steering gear and tighten securely. Connect cable 25 to connectors (H, fig. 161).

### **186. Stoplight Switch**

*a. Removal.* Disconnect cables 75 at double connector (K, fig. 161) on stoplight switch. Unscrew stoplight switch (L, fig. 161) from the master cylinder outlet fitting bolt.

*b. Installation.* Screw stoplight switch (L, fig. 161) into the master cylinder outlet fitting bolt and tighten securely. Connect cables 75 at double connector (K, fig. 161) on switch. Bleed brakes (par. 237).

### **187. Engine Oil Pressure Sending Unit**

(fig. 120)

*a. Removal.* Disconnect cable 36 connector from the engine oil pressure sending unit receptacle. Unscrew the sending unit oil line nut from the elbow connector and pull the line free from the connector.

*Note.* Use care in pulling line free from connector to prevent binding of line. Loosen the nut and bolt in the support and drop sending unit out of support.

*b. Installation.* Insert the engine oil pressure sending unit into the support and tighten the support nut and bolt. Insert the sending unit oil line nut into the elbow connector and tighten securely. Connect cable 36 connector to the receptacle in the sending unit.

### **188. Engine Water Temperature Sending Unit**

(fig. 120)

*a. Removal.* Drain cooling system (par. 127a(1)). Disconnect cable 33 from receptacle in engine water temperature sending unit. Unscrew and remove sending unit from cylinder head.

*b. Installation.* Screw the engine water temperature sending unit into the cylinder head and tighten securely. Connect cable 33 connector to receptacle in sending unit. Refill cooling system (par. 127a(2)).

### **189. Fuel Level Sending Unit**

*a. Removal (M38A1).* Remove driver's seat (par. 261a(1)). Disconnect cable 28 (N, fig. 69) connector from receptacle in fuel level

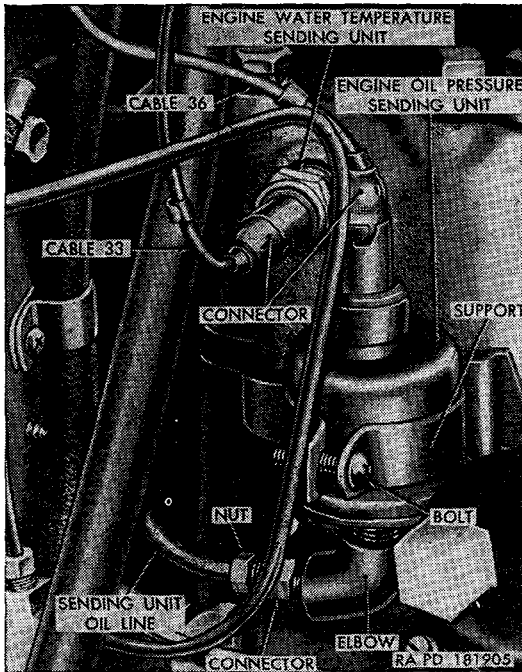

Figure 120. Engine oil pressure and engine water temperature sending units—installed.

sending unit. Remove the five bolts and soft copper washers and lift sending unit out of fuel tank. Remove and discard the fuel level sending unit gasket from either the tank or unit.

*b. Installation (M38A1).* Clean fuel tank of any old gasket materials. Position a new fuel level sending unit gasket on the fuel tank, aligning the mounting holes in the gasket with mounting holes in tank. Insert the fuel level sending unit into the tank and rotate unit to align the mounting holes. Secure unit in position with five No. 8 x 1/2 bolts and soft copper washers. Connect cable 28 connector to receptacle in sending unit. Install driver's seat (par. 261a(2)).

*c. Removal (M170).* Refer to paragraph 141a(2), (3), (5), and (11).

*d. Installation (M170).* Refer to paragraph 141b(1), (8), (12), and (13).

## Section XV. CLUTCH

### 190. Description and Data

*a. Description.* The clutch, located between the engine and transmission, is a single disk, dry-type, composed of two major units, the clutch pressure plate (fig. 125) and the driven disk. The controlled pressure of the driven disk against the engine flywheel provides a

means of engaging or disengaging the engine power from the transmission. The clutch is always engaged unless disengaged by depressing the clutch pedal.

*b. Data.*

Type ----- Single dry plate  
Torque capacity ----- 144 ft-lb  
Clutch driven plate w/facing assembly :  
    Make ----- Borg and Beck  
Facing material ----- two molded asbestos  
    Facing diameter, inside -----  $5\frac{1}{8}$  in.  
    Facing diameter, outside -----  $8\frac{1}{2}$  in.  
    Facing thickness ----- 0.138 in.  
Clutch pressure plate assembly :  
    Make ----- Auburn  
    Number of springs ----- 6

### 191. Clutch Linkage Adjustment

*a.* As the clutch facings wear, the free travel of the clutch pedal diminishes. Check the clutch pedal free travel (fig. 121) periodically to make certain the clutch pedal has at least  $1\frac{1}{4}$  inches of free travel before the clutch starts to disengage.

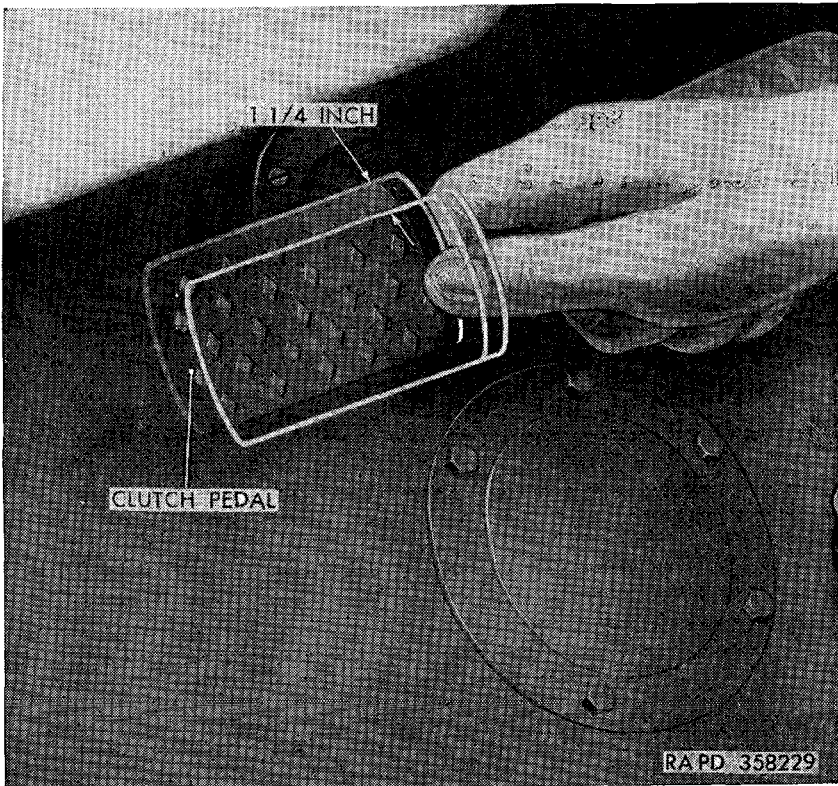

Figure 121. Clutch pedal free travel.

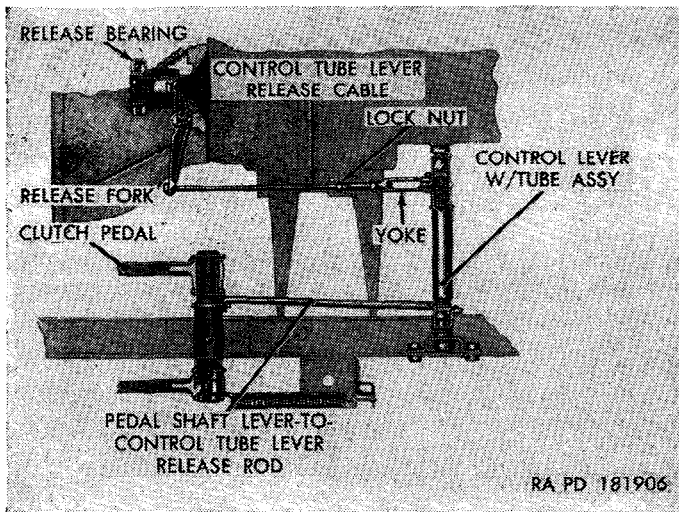

Figure 122. Clutch linkage adjustment.

b. Loosen the lock nut (fig. 122) that locks the yoke to the control tube lever release cable. Unscrew the yoke from the cable until the clutch pedal has  $1\frac{1}{4}$ -inch free travel. Tighten the lock nut against the yoke after the adjustment is made.

## Section XVI. TRANSMISSION

### 192. Description and Data

a. *Description.* The transmission (fig. 123) is a synchro-mesh, selective-gear-type, with three forward speeds and one reverse. Speed selection is accomplished manually by manipulating the transmission gear shift lever. The lever extends out of the top of the control lever housing into the driver's compartment of the vehicle.

b. *Data.*

Make----- Borg-Warner Corp,  
Warner Gear Div.  
Type----- synchromesh  
Speeds----- three forward, one reverse  
Ratios:  
    Low (first)----- 2.798 to 1  
    Intermediate (second)----- 1.551 to 1  
    High (third)----- 1.000 to 1  
    Reverse----- 3.798 to 1  
Lubricant capacity----- 2 pt

### 193. Coordination With Ordnance Maintenance Unit

Refer to paragraph 2 for information on coordination with an ordnance maintenance unit.

## 194. Organizational Maintenance

Organizational maintenance of the transmission consists of lubrication (par. 69), inspection for looseness or noise, and the testing of the gearshift lever for proper operation.

## 195. Transmission Removal

- a. Remove the power plant (par. 120).
- b. Remove the transfer (par. 199).
- c. Remove six lockwasher screws securing the linkage inspection covers (fig. 123) to the top of the clutch bell housing. Remove the cover and gasket. Working through the inspection hole, disconnect the control tube lever release cable from the end of the release fork. Disengage the fork from the release bearing carrier and lift the fork out of the clutch compartment. Discard gasket.
- d. While supporting the transmission, remove the four bolts and copper washers (fig. 123) securing the transmission to the clutch bell housing. Pull the transmission straight back until the transmission input shaft is clear of the bell housing.

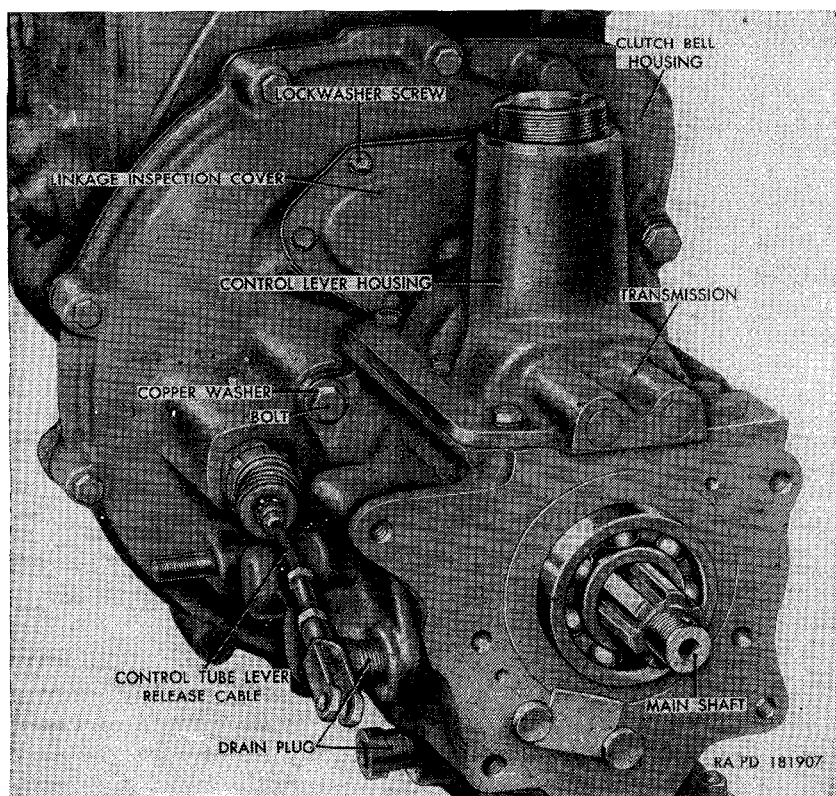

Figure 123. Transmission rear view, transfer removed—power plant removed from vehicle.



e. Disconnect the release bearing carrier spring (fig. 124) from the transmission input shaft bearing cover. Slide the release bearing carrier and release bearing off the input shaft. Remove the release fork ball stud from the bearing cover.

f. Remove the three socket-head cap screws and gaskets securing the input shaft bearing cover (fig. 124) to the front face of the transmission. Slide the cover off the input shaft and remove the case-to-bell housing gasket. Discard gasket.

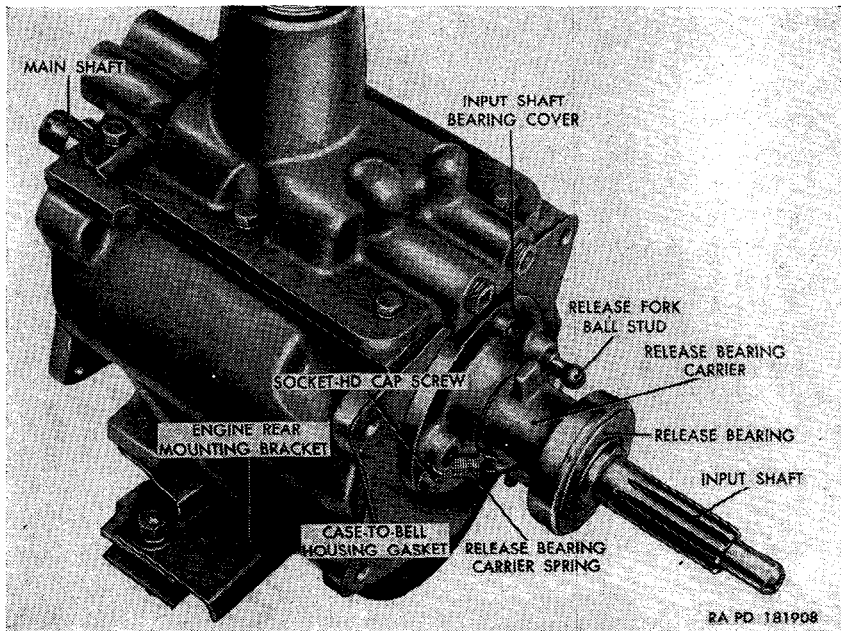

Figure 124. Transmission removed from power plant.

g. Remove the four bolts and lockwashers securing the engine rear mounting bracket to the bottom of the transmission and remove the bracket.

## 196. Transmission Installation

a. Position the engine rear mounting bracket (fig. 124) on the bottom of the transmission. Secure the bracket to the transmission with four  $\frac{3}{8}$ -inch lockwashers and  $\frac{3}{8} \times \frac{5}{8}$  bolts.

b. Coat a new case-to-bell housing gasket (fig. 124) with plastic-type gasket cement. Position the gasket against the front face of the transmission, aligning the gasket holes with the transmission holes. Slide the transmission input shaft bearing cover over the shaft and into position against the gasket. Secure the cover and gasket to the transmission with three  $\frac{5}{16}$ -inch screw gaskets and  $\frac{5}{16} \times 1\frac{1}{4}$  socket-head cap screws.

c. Slide the release bearing carrier (fig. 124) and release bearing on to the input shaft, making certain to position the two flanges vertically as shown in figure 124. Connect the release bearing carrier spring to the bearing cover on the transmission. Install the release fork ball stud in the bearing cover hole.

d. Aline the input shaft splines with the clutch driven disk (fig. 125) hub splines and insert the input shaft through the disk hub until it seats in the engine flywheel clutch pilot bearing. Secure the

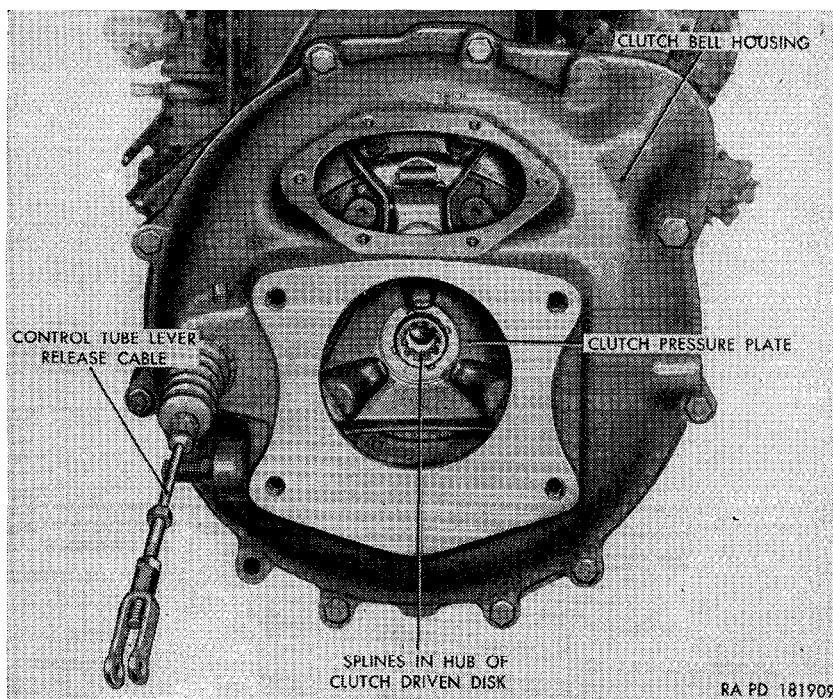

Figure 125. Clutch bell housing—rear view—transmission removed.

transmission to the clutch bell housing with four  $\frac{7}{16}$ -inch copper washers and  $\frac{7}{16} \times 1\frac{1}{4}$  bolts (fig. 123). Tighten the bolts evenly.

e. Working through the inspection hole in the top of the bell housing, install the release fork so the fork recess engages the bearing cover ball stud, and with the two large ends of the fork behind the release bearing carrier flanges. Engage the control tube lever release cable ball behind the two projections at the small end of the fork. Coat a new linkage inspection cover gasket with plastic-type liquid cement. Place the gasket and the inspection cover in position on top of the clutch ball housing (fig. 123). Secure cover and gasket to bell housing with six  $\frac{1}{4} \times \frac{1}{2}$  lockwasher screws.

f. Install transfer (par. 200).

g. Install the power plant (par. 124).

h. Record the replacement of the transmission on DA Form 478.

## Section XVII. TRANSFER

### 197. Description and Data

*a. Description.* The transfer is an auxiliary, two-speed gear unit, attached to the rear of the transmission. The transfer transmits power from the transmission to the front and rear differentials through propeller shafts. By manipulation of two transfer gearshift levers (T, fig. 11), additional high and low speed ranges can be selected, and power to the front axle can be connected or disconnected. The hand brake drum (fig. 126) and shoes are mounted on the rear of the transfer. A cover at the rear of the transfer provides access to the interior of the assembly when installing a power takeoff.

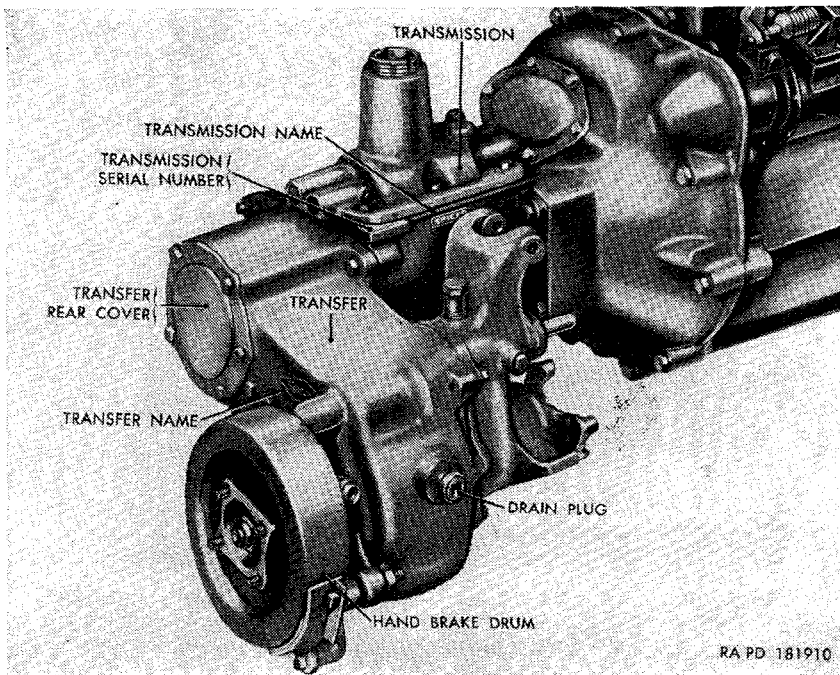

Figure 126. Transfer and transmission assemblies installed on engine—power plant removed from vehicle.

#### *b. Data.*

Make..... Spicer Mfg Corp  
Model..... 18  
Ratios:  
    Low range..... 2.43 to 1  
    High range..... 1.00 to 1  
Lubricant capacity..... 3 pt

### 198. Coordination With Ordnance Maintenance Unit

Refer to paragraph 2 for information on coordination with an ordnance maintenance unit.

## 199. Transfer Removal

- a. Remove the power plant (par. 120).
- b. Remove the drain plugs from the transmission (fig. 123) and transfer (fig. 126) and permit the lubricant to drain. After draining completely, install the drain plugs.
- c. Remove five bolts and external-teeth lockwashers securing the transfer rear cover (fig. 126) to the transfer case. Remove the cover and rear cover gasket. Discard gasket.
- d. Shift transmission out of neutral and remove the cotter pin, nut (fig. 127), and washer securing the transfer drive gear to the transmission main shaft. Shift transmission back to neutral. Pull the drive gear off the shaft.

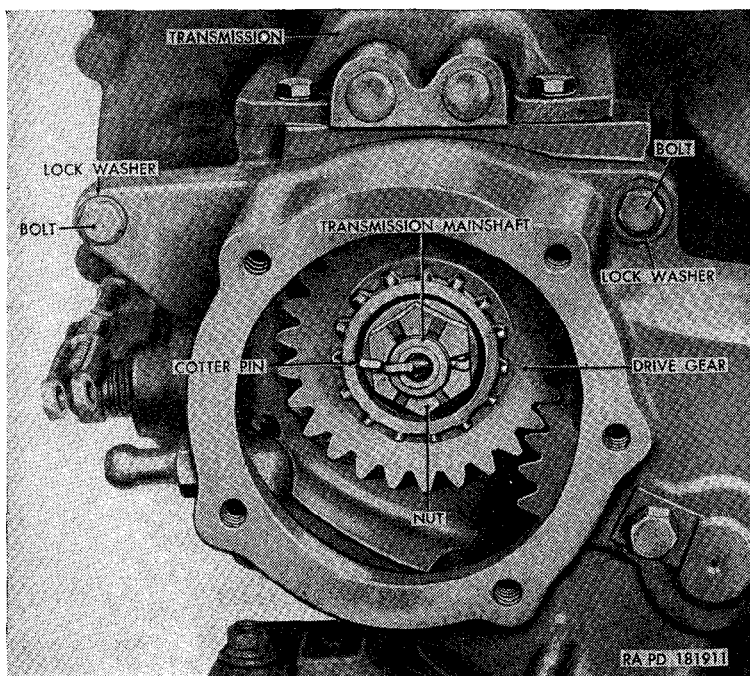

Figure 127. Transfer drive gear installed.

- e. While supporting the transfer, remove the four bolts and lockwashers (fig. 127) two at the top, and two at the bottom, securing the transfer to the transmission. Remove a fifth bolt and lockwasher securing the transfer to the transmission from the lower right rear of the transmission flange.
- f. Pull the transfer straight back until it clears the bearing mounted on the transmission main shaft.
- g. Remove and discard the transfer case-to-transmission gasket.
- h. Remove the nut (fig. 128) and washer securing the companion flange to the rear axle output shaft. Using a suitable puller, pull the

companion flange and hand brake drum off the shaft. Remove the four bolts securing the drum to the flange and separate the drum from the flange.

i. Remove the nut and lockwasher securing the anchor pin (fig. 128) to the transfer. Pull the anchor pin, with inner and outer shoes attached, from the transfer.

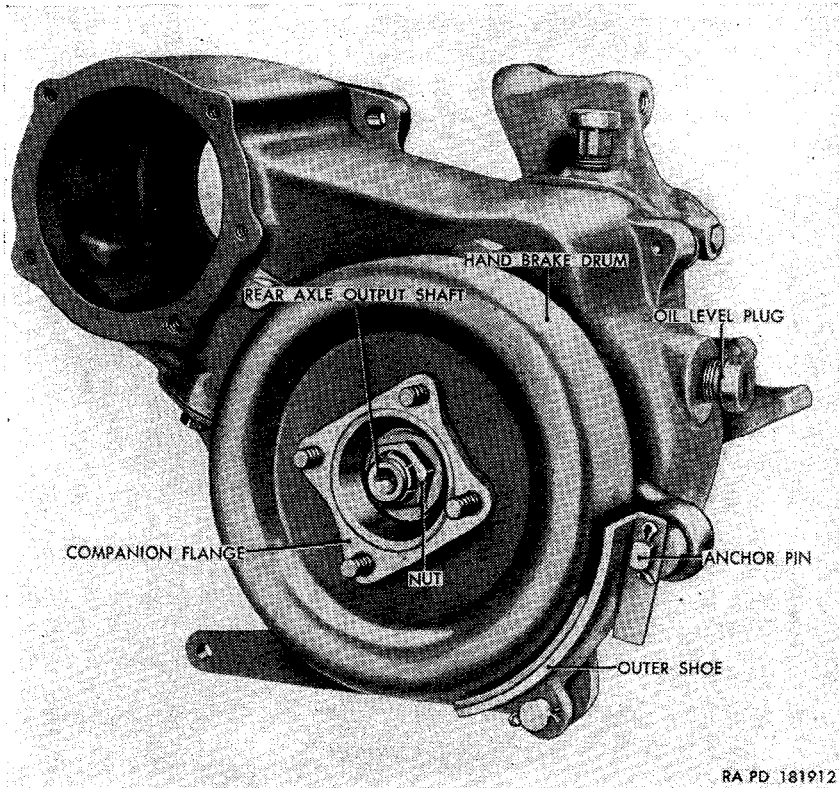

Figure 128. Transfer removed.

## 200. Transfer Installation

a. Insert the anchor pin (fig. 128), with inner and outer shoe attached, through the hole in the retainer of the transfer. Secure the pin to the retainer with one  $\frac{5}{8}$ -inch washer and nut.

b. Position the hand brake drum (fig. 128) on the companion flange, with the drum rim toward the flange hub. Secure the drum to the flange with four  $\frac{3}{8} \times 1\frac{1}{8}$  bolts with bolts in position shown in figure 128. Aline the flange splines with the rear axle output shaft splines. Install the flange on the shaft, making certain the inner and outer shoes are alined to mate with the brake drum rim. Using a soft mallet, tap the flange into position on the shaft. Secure the flange to the shaft with one  $\frac{3}{4}$ -inch washer and  $\frac{3}{4}$ -inch nut.

c. Make certain the transfer and transmission mating surfaces are clean and free of old gasket material. Coat a new transfer case-to-transmission gasket with plastic-type gasket cement and position the gasket on the front side of the transfer case. Make certain the transmission main shaft bearing is in place against the transmission rear flange. Position the transfer assembly on the rear of the transmission assembly. Secure the transfer to the transmission with four  $\frac{3}{8}$  x  $1\frac{1}{8}$  bolts (fig. 127).

*Note.* The four  $\frac{3}{8}$  x  $1\frac{1}{8}$  bolts are installed from the rear side of the transfer flange into the transmission. The  $\frac{3}{8}$  x 1 bolt is installed through the rear flange of the transmission into the transfer.

Draw the bolts up evenly.

d. Working through the opening at the rear of the transfer, slide the transfer drive gear onto the transmission main shaft. Making certain the drive gear teeth are mated with the transfer countershaft gear teeth. Secure the gear to the shaft with one  $\frac{7}{8}$ -inch washer,  $\frac{7}{8}$ -inch nut, and  $\frac{1}{8}$  x  $1\frac{1}{4}$  cotter pin.

*Note.* Shift transmission out of neutral, if necessary, to prevent main shaft turning when nut is tightened.

e. Coat a new rear cover gasket with plastic type gasket cement and position gasket and transfer rear cover (fig. 126) on the rear of the transfer case. Secure the cover to the case with five  $\frac{3}{8}$ -inch external-teeth lockwashers and five  $\frac{3}{8}$  x  $\frac{3}{4}$  bolts.

f. Install the power plant (par. 124).

g. Record the replacement of the transfer on DA Form 478.

## Section XVIII. PROPELLER SHAFTS WITH UNIVERSAL JOINTS

### 201. Description and Data

a. *Description.* The front propeller shaft (fig. 129) with universal joints transmits power from the transfer to the front axle. The rear propeller shaft (fig. 130) with universal joints transmits power from the transfer to the rear axle. Each assembly includes a propeller shaft, a universal joint sleeve yoke, and two universal joints. Corresponding parts of the front and rear assemblies are similar except for the length of the shaft, and the front universal joints of the rear propeller shaft. This universal joint includes the propeller shaft flange yoke, and is modified accordingly.

b. *Data.*

Manufacturer..... Spicer Mfg Corp  
Type of shaft..... tube, with welded seam  
Type of joints..... roller bearing

## 202. Front Propeller Shaft With Universal Joints

(fig. 129)

### a. Removal.

- (1) Remove the four safety nuts from the two **U**-bolts securing the rear universal joint to the transfer-front axle output shaft yoke. Remove the **U**-bolts and separate the universal joint from the yoke.
- (2) Loosen and remove the four safety nuts from the two **U**-bolts securing the front universal joint to the front axle end yoke with shield assembly. Remove the **U**-bolts, and remove the front propeller shaft with universal joints from under the vehicle.

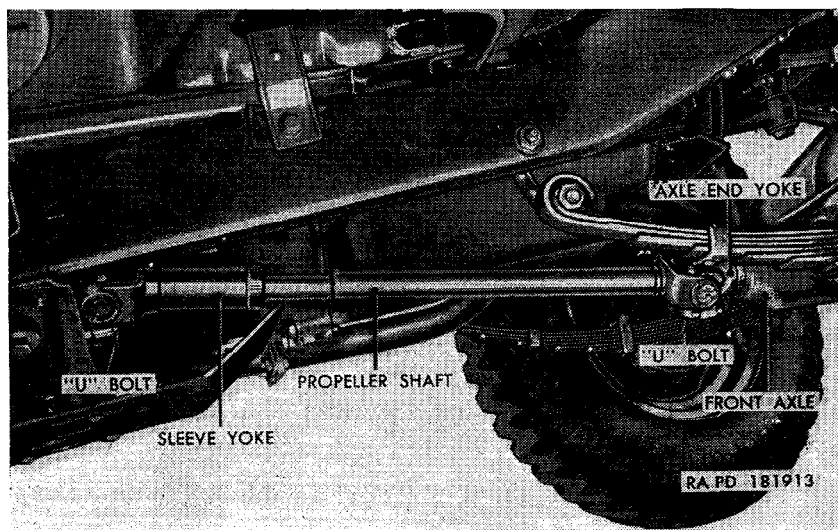

Figure 129. Front propeller shaft with universal joint assembly—installed.

### b. Installation.

- (1) Position the front propeller shaft with universal joints under the front of the vehicle and insert the front universal joint into the front axle end yoke with shield assembly. Place the two **U**-bolts over the two exposed journal bearings and insert the **U**-bolt ends through the holes in the axle end yoke. Secure the **U**-bolts to the yoke with four  $\frac{5}{16}$ -inch safety nuts.
- (2) Insert the rear universal joint into the transfer-front axle output shaft yoke. Place the two **U**-bolts over the two exposed journal bearings and insert the **U**-bolt ends through the holes in the yoke. Secure the **U**-bolts to the yoke with four  $\frac{5}{16}$ -inch safety nuts.

## 203. Rear Propeller Shaft With Universal Joints

(fig. 130)

### a. Removal.

- (1) Remove the four safety nuts from the two U-bolts securing the rear universal joint to the rear axle end yoke. Remove the U-bolts, and separate the universal joint from the yoke.
- (2) Loosen the four nuts on the bolts securing the rear propeller shaft flange yoke to the transfer companion flange. Remove the nuts and lockwashers, and remove the propeller shaft with universal joints from under the vehicle.

### b. Installation.

- (1) Position the rear propeller shaft with universal joints under the rear of the vehicle. Position the rear propeller shaft

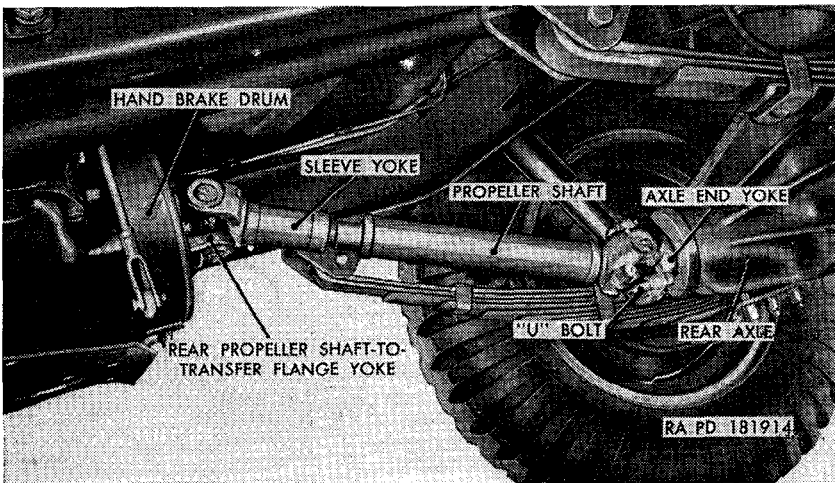

Figure 130. Rear propeller shaft with universal joints—installed.

flange yoke on the four  $\frac{3}{8}$ -inch bolts projecting from the transfer companion flange. Place four  $\frac{3}{8}$ -inch lockwashers and  $\frac{3}{8}$ -inch nuts on the ends of the bolts, and tighten the nuts.

- (2) Insert the rear universal joint into the rear axle end yoke. Place two U-bolts over the two exposed journal bearings, and insert the ends of the U-bolts through the holes in the yoke. Secure the U-bolts to the yoke with four  $\frac{5}{16}$ -inch safety nuts.

## 204. Universal Joints

a. *Front Propeller Shaft Universal Joints Disassembly* (fig. 131). Procedures for disassembly of both universal joints of the front propeller shaft with universal joints are the same.

- (1) Remove front propeller shaft with universal joints (par. 202a).



- (2) Remove the two loose journal bearings and oil seals from journal, being careful not to lose the rollers. Do not remove the plug.
- (3) Remove the two journal bearing snap rings from the yoke by squeezing the open ends of the ring together with pliers. Place a brass drift against the end of one of the bearings and drive the bearing into the yoke until the bearing on the opposite end of the journal is driven out of the yoke. Pull the protruding bearing and journal bearing oil seal from the

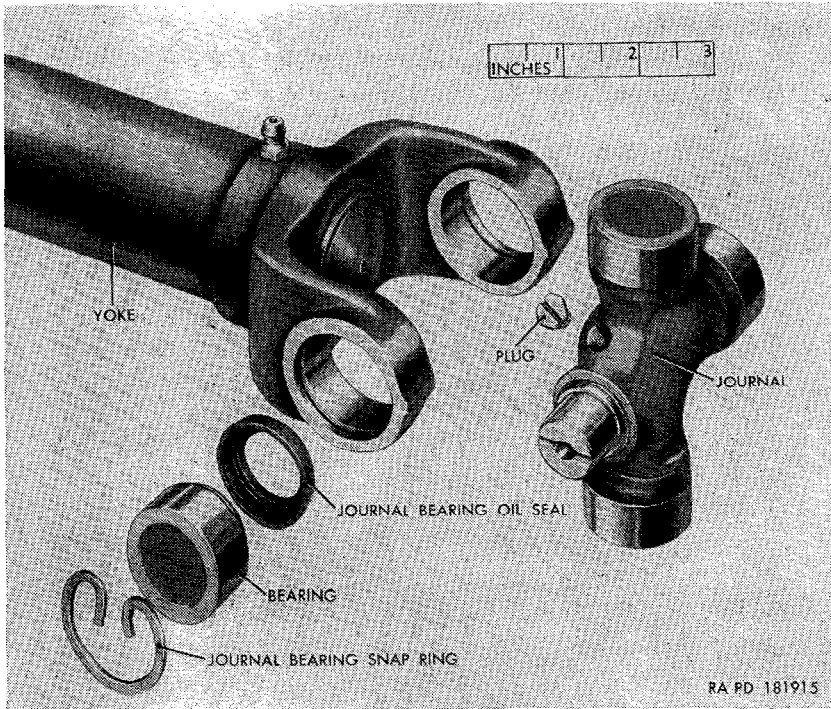

Figure 131. Front propeller shaft universal joint and yoke—partially exploded view.

journal, being careful not to lose the rollers. Using the brass drift against the end of the journal from which the bearing has been removed, drive the journal back until the other bearing has been driven out of the yoke. Pull the second bearing and the journal bearing oil seal from the journal, being careful not to lose the rollers. Slide the yoke to one side of the journal and work the journal out of the yoke.

b. *Front Propeller Shaft Universal Joints Assembly* (fig. 131). Procedures for assembly of both universal joints of the front propeller shaft with universal joints are the same.

- (1) Push a journal bearing oil seal onto each of the two journal ends, convex side first. Insert the journal into the yoke holes.
- (2) Carefully start the two bearings onto the journal ends and into the yoke holes. Using a brass drift, carefully tap the bearings in until their outer ends are just inside the snap ring grooves in the holes. Install the two journal bearing snap rings by squeezing the ends together with pliers.
- (3) Push a journal bearing oil seal onto each of two journal ends, convex side first. Push a bearing onto each journal end.
- (4) Install the front propeller shaft with universal joints (par. 202*b*).

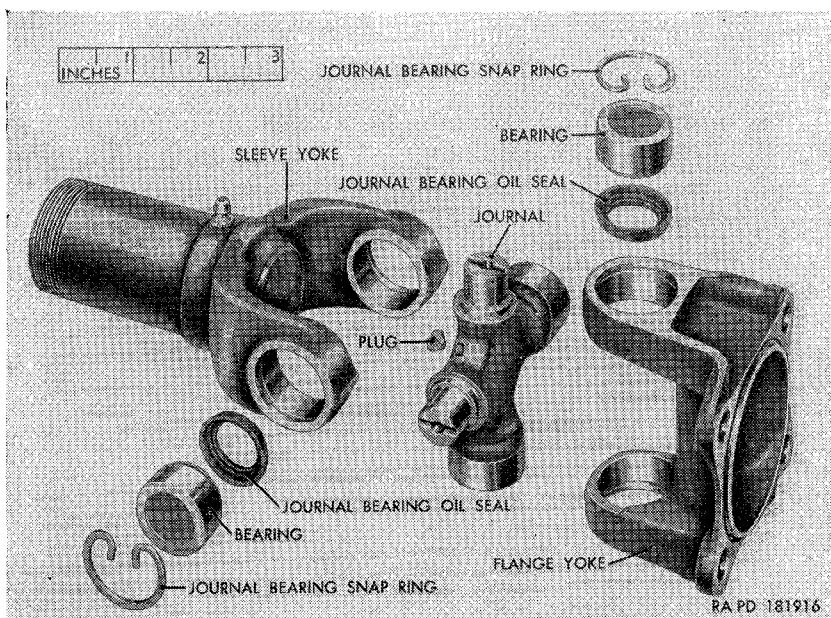

Figure 132. Rear propeller shaft front universal joint and rear propeller shaft-to-transfer flange yoke—partially exploded view.

*c. Rear Propeller Shaft Universal Joints Disassembly.* Remove the rear propeller shaft with universal joints (par. 203*a*). Procedure for disassembly of the rear universal joint of the rear propeller shaft is the same as the procedure for disassembly of the universal joints of the front propeller shaft (*a*(2) and (3) above). For disassembly of the front universal joint of the rear propeller shaft, refer to figure 132.

- (1) Follow the procedure of *a*(3) above to remove journal and bearings from the sleeve yoke.
- (2) Follow the procedure of *a*(3) above to remove journal and bearings from the rear propeller shaft-to-transfer flange yoke.

*d. Rear Propeller Shaft Universal Joints Assembly.* Procedure for assembly of the rear universal joint of the rear propeller shaft is the same as the procedure for assembly of the universal joints of the front propeller shaft (*b* above). For assembly of the front universal joint of the rear propeller shaft, refer to figure 132.

- (1) Follow the procedure of *b*(1) and (2) above to install the journal and bearings in the sleeve yoke.
- (2) Follow the procedure of *b*(1) and (2) above to install the journal and bearings in the rear propeller shaft-to-transfer flange yoke.
- (3) Install the rear propeller shaft with universal joints (par. 203*b*).

## 205. Universal Joint Sleeve Yoke Assemblies

*a. General.* The universal joint sleeve yoke assemblies (figs. 129 and 130) used on the front and rear propeller shafts are practically identical. Removal and installation procedures for both are referenced to figure 133.

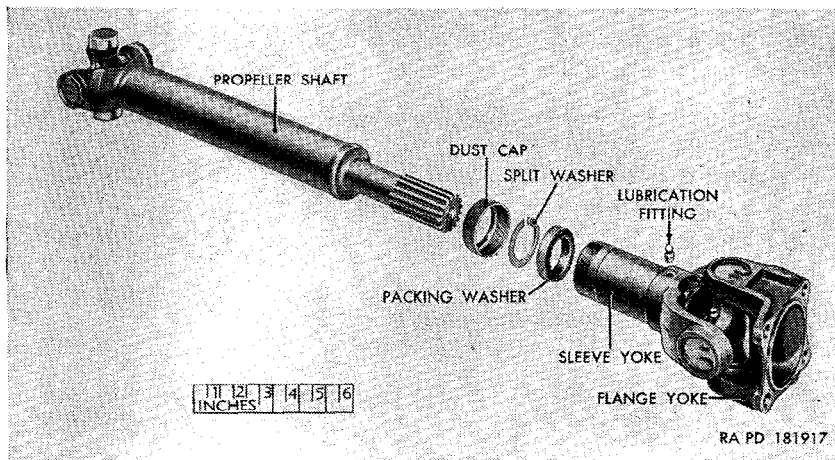

Figure 133. Rear propeller shaft with universal joints—partially exploded view.

*b. Universal Joint Sleeve Yoke Removed* (fig. 133).

- (1) Remove the propeller shaft with universal joints (par. 202*a* or 203*a*).
- (2) Unscrew the dust cap from the sleeve yoke and slide the yoke with universal joint off the splined shaft. Remove the packing washer and the split washer from the dust cap. Work the two washers and cap off the shaft over the splines. Unscrew and remove the lubrication fitting.
- (3) Follow the procedure described in paragraph 204*a*(3).

*c. Universal Joint Sleeve Yoke Installation (fig. 133).*

- (1) Follow the procedure described in paragraph 204*b*(1) and (2).
- (2) Slide universal joint sleeve yoke dust cap over splines on the propeller shaft, convex side first. Slide universal joint sleeve yoke dust cap split washer over splines, and install in dust cap. Slide universal joint sleeve yoke dust cap packing washer over splines and install in cap. Slide the universal joint sleeve yoke with universal joint assembly onto the propeller shaft splined end. Screw the universal joint sleeve yoke dust cap, with the two washers inclosed, onto the yoke end. Insert the lubrication fitting into the yoke hole and tighten the fitting.
- (3) Install the propeller shaft with universal joints (par 202*b* or 203*b*).

## Section XIX. FRONT AXLE

### 206. Description and Data

*a. Description.* The front axle is a full floating-type, enclosing a front wheel driving unit, having a single reduction, two pinion differential, and hypoid drive gear. The differential carrier housing is offset to the right so that the propeller shaft is located to the right of the engine for maximum ground clearance. A cover provides easy access to the differential unit.

*b. Data.*

Manufacturer.....	Spicer Mfg Corp
Model.....	25
Drive gear ratio.....	5.38-1
Drive type.....	Hotchkiss
Axle type.....	full floating
Differential type.....	2 pinion
Differential drive gear type.....	hypoid
Turning angle.....	25 deg
Lubricant capacity.....	1¼ qt

### 207. Front Axle Shafts With Universal Joints

*Note.* The removal and installation procedures described in this paragraph apply to either left or right axle shaft assemblies. The key letters noted in parentheses are in figure 134, except where otherwise indicated.

*a. Removal.*

- (1) Jack up the vehicle and remove the wheel (par. 250*a*).
- (2) Pry off the hub cap (A) and remove the six screws (C) and lockwashers (D).
- (3) Remove the hub cap seal (B) from the drive shaft flange (E) recess. Install a suitable puller over the flange lip and

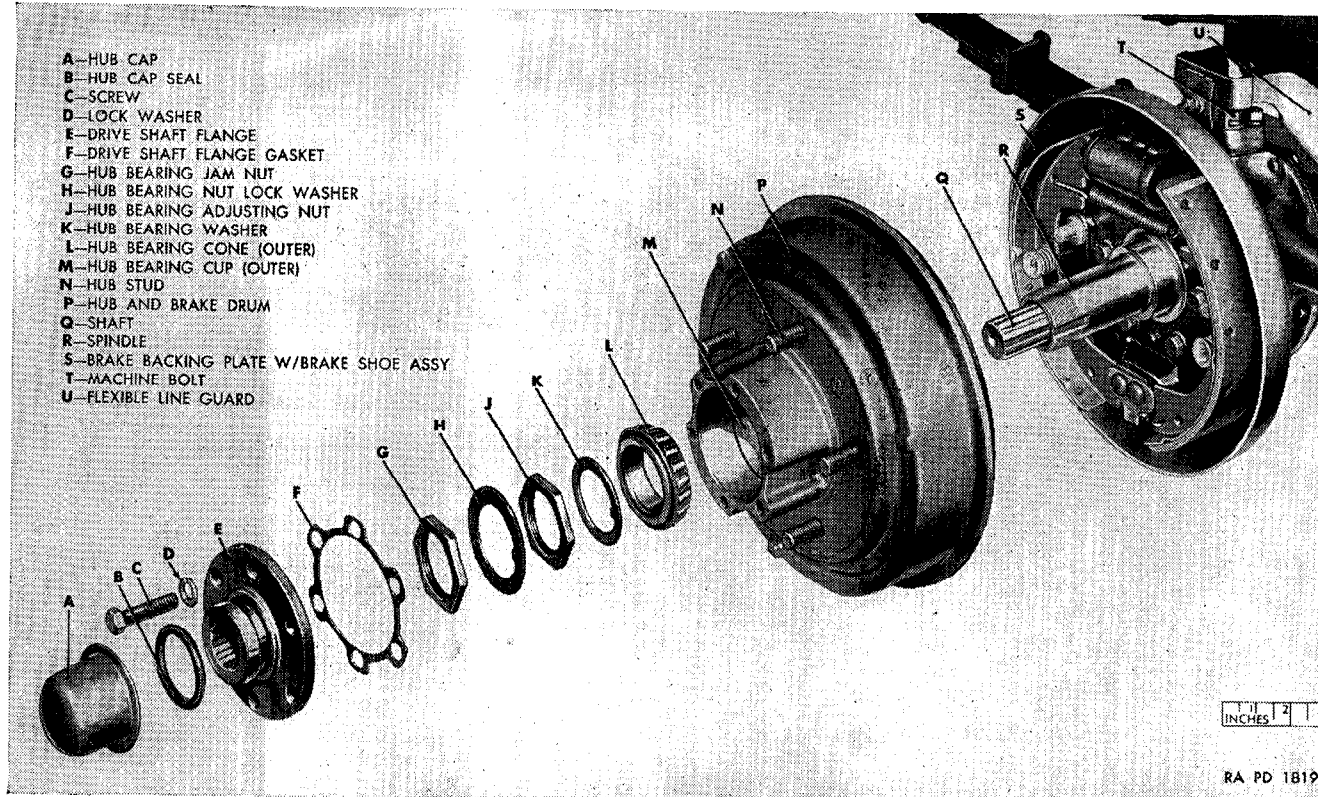
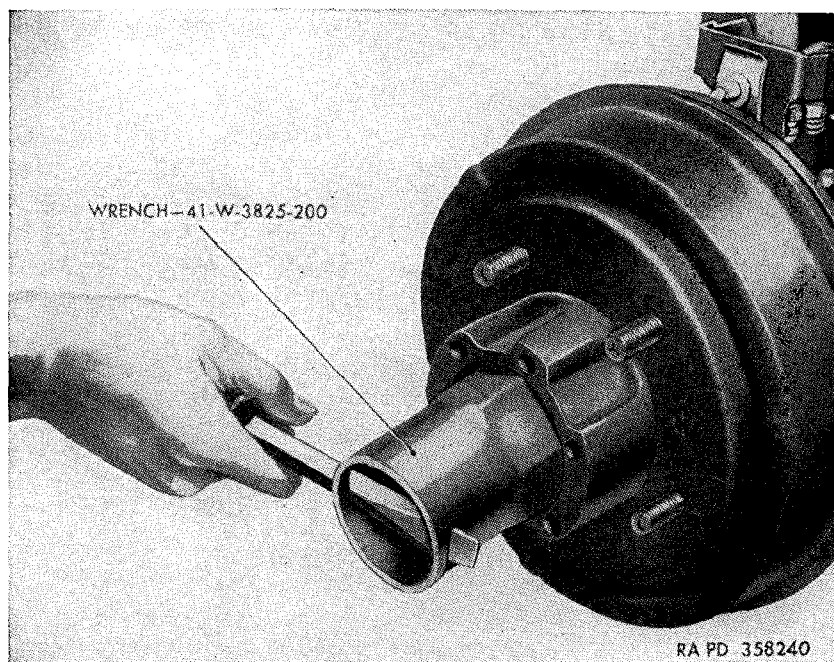

Figure 134. Front axle—partially exploded view.

pull the flange from the shaft. Separate and discard the drive shaft flange gasket (F) from the flange.

- (4) Straighten the hub bearing nut lockwasher (H) bent edge sufficiently to clear the hub bearing jamnut (G).
- (5) Position wrench 41-W-3825-200 (fig. 135) on the jamnut and unscrew the nut from the spindle. Slide the lockwasher off the spindle.
- (6) Using wrench 41-W-3825-200, unscrew the hub bearing adjusting nut (J) and remove the nut and hub bearing washer (K) from the spindle.



*Figure 135. Removing hub bearing jamnut, using wrench—41-W-3825-200.*

- (7) Pull the hub and brake drum (P) from the spindle, and remove the hub bearing cone (outer) (L) from the hub. The hub bearing cone (inner) will remain in the hub.
- (8) Unscrew the nut securing the front wheel cylinder line (G, fig. 136) to the front wheel cylinder assembly.
- (9) Remove the six machine bolts (A, fig. 136) and lockwashers securing the brake backing plate with brake shoe assembly (C, fig. 136) and the spindle with bearing assembly (D, fig. 136) to the steering knuckle flange with arm assembly (F, fig. 136). Remove the brake backing plate with brake shoe assembly off the spindle. Remove the spindle from the steering knuckle flange.

(10) Withdraw the shaft with universal joint assembly (E, fig. 136) from the axle housing.

*b. Installation.*

- (1) Insert the shaft with universal joint assembly (E, fig. 136) through the steering knuckle flange with arm assembly (F, fig. 136) and into the axle housing. Rotate the shaft until it can be started into the differential side gear. With a soft mallet, tap the shaft until it seats in the housing.
- (2) Place the spindle with bearing assembly (D, fig. 136) on the shaft with the spindle mounting holes alined with the steering knuckle flange mounting holes, and tap the spindle into position against the flange. Place the brake backing plate

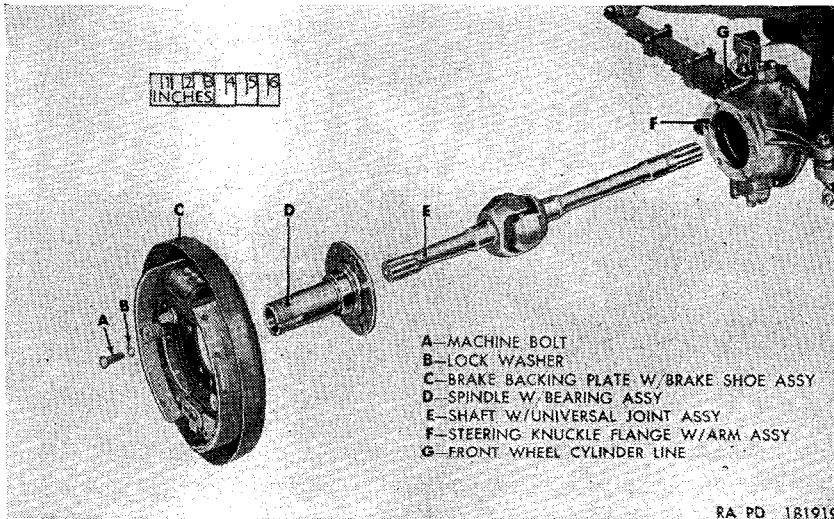

Figure 136. Shaft with universal joint, spindle with bearing, and brake backing plate with brake shoe assemblies—partially exploded view.

with brake shoe assembly (C, fig. 136) on the spindle with the backing plate mounting holes alined with the spindle and steering knuckle flange mounting holes. Secure the backing plate and spindle to the flange with six  $\frac{3}{8}$ -inch lockwashers and  $\frac{3}{8} \times 3\frac{3}{4}$  bolts (A and B, fig. 136).

- (3) Screw the front wheel cylinder line (G, fig. 136) nut into the front wheel cylinder assembly.
- (4) Place the hub and brake drum (P) on the spindle. With the small end of the bearing taper toward the vehicle, insert the hub bearing cone (outer) (L) into the hub, and press into position.
- (5) Slide the hub bearing washer (K) on the spindle shaft with the washer tang in the shaft slot. Screw the hub bearing adjusting nut (J) on the spindle shaft, fingertight.

- (6) Position the wheel on the wheel hub and brake drum. Screw five  $\frac{1}{2}$ -inch nuts on the hub studs (left wheel, counterclockwise; right wheel, clockwise). Tighten the nuts alternately and evenly.
- (7) Adjust the front hub bearing (par. 208a(2)).
- (8) Slide the hub bearing nut lockwasher (H) on the spindle shaft with the washer tang in the shaft slot. Screw the hub bearing jamnut (G) on the spindle shaft, and tighten nut with the wheel bearing nut wrench—41-W-3825-200 (fig. 135).
- (9) Bend the lockwasher edge to engage one flat of the jamnut.
 

**Caution:** Never use a point next to the hub mounting holes as a fulcrum.
- (10) Apply a little grease to the gasket surface of the drive shaft flange (E) and place a new drive shaft flange gasket (F) on the flange with the gasket holes alined with the flange holes.
- (11) Place the flange and gasket on the shaft and aline the flange splines with the shaft splines. With a soft mallet, tap the flange and gasket part way onto the shaft. Turn the hub and drum to aline the flange mounting holes with the hub mounting holes. Tap the flange completely onto the shaft and secure to the hub with six  $\frac{3}{8}$ -inch lockwashers and  $\frac{3}{8} \times \frac{3}{4}$  bolts.
- (12) Slip the hub cap seal (B) over the drive shaft flange end and into the flange recess.
- (13) Place the hub cap (A) over the flange end and tap into position.
- (14) Bleed the brakes (par. 237).
- (15) Remove the safety stands or blocking and lower vehicle to the ground.

## 208. Front Hub Bearings

### a. Adjustment.

- (1) Jack up the vehicle and follow the procedure described in paragraph 207a(2) through (5).
- (2) With wrench 41-W-3825-200 (fig. 135), tighten the hub bearing adjusting nut (J, fig. 134) until the bearings begin to bind when the wheel is turned. Back off on the adjustment one-sixth turn or until the wheel just turns freely.
- (3) Follow the procedure described in paragraph 207b(8) through (13), and (15).

### b. Removal.

- (1) Follow the procedure described in paragraph 207a(1) through (7).



- (2) Using a brass drift, tap the hub (inner) bearing cone and hub bearing oil seal (fig. 137) out of the hub. Discard oil seal.
- (3) Install the remover and replacer 41-R-2374-845 and screw 41-S-1047-330 (fig. 138) in the hub bearing cup (inner) (fig. 137) and drive the cup out of the hub. Reverse the hub and, with the remover and replacer 41-R-2374-845 and screw 41-S-1047-330, drive the hub bearing cup (outer) from the hub.

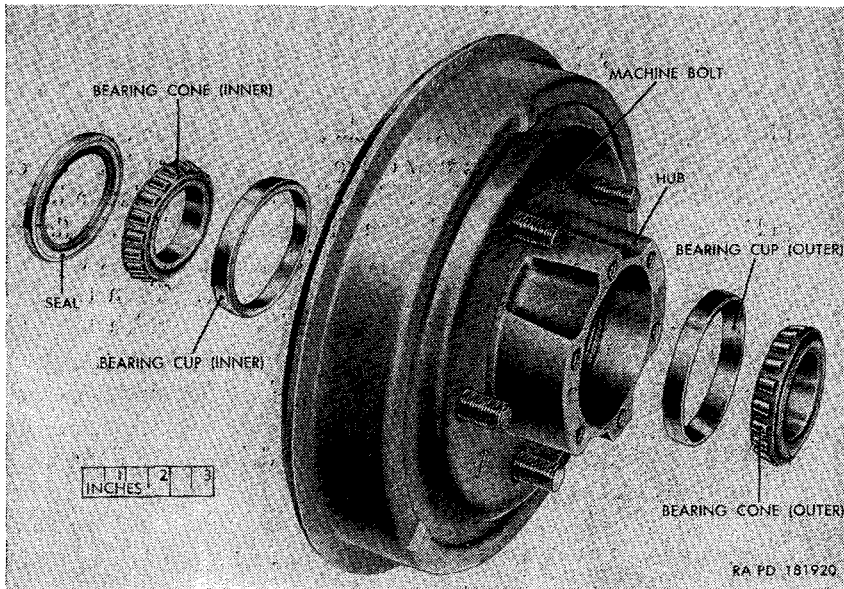

Figure 137. Front hub and drum, inner and outer bearing, and oil seal assemblies—exploded view.

*c. Cleaning and Packing.* Clean all lubricant from front hub bearing cups and cones with dry-cleaning solvent or volatile mineral spirits. Pack bearing cones with the grease prescribed in paragraph 69. If a bearing packer is not available, pack bearings by hand, working grease into cone rollers. Keep bearing cones clean.

*d. Installation.*

- (1) Insert the small inside diameter end of the hub bearing cup (outer) (fig. 137) into the brake drum side of the hub. Place the remover and replacer 41-R-2374-845 and screw 41-S-1047-330 (fig. 138) in the hub and drive cup into position.
- (2) Insert the small inside diameter end of the hub bearing cup (inner) (fig. 137) into the brake assembly side of the hub. Place the remover and replacer 41-R-2374-845 and screw

41-S-1047-330 (fig. 138) in the hub and drive cup into position.

- (3) With the small end of the bearing cone taper toward the brake drum, insert the hub bearing cone (inner) (fig. 137) into the hub.
- (4) Place a new hub bearing oil seal in the brake assembly side of the hub, with the lip of the seal facing the cone. With a soft mallet, tap on the seal until it is flush with the hub.

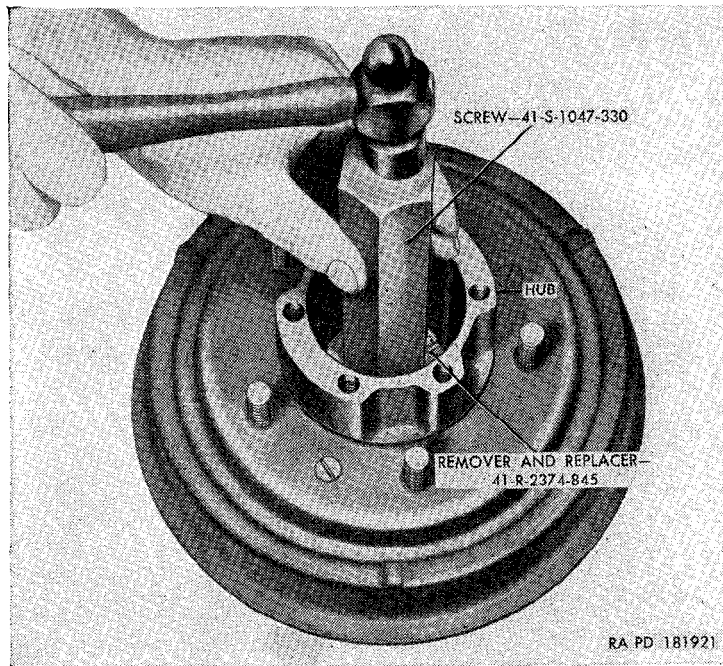

*Figure 138. Removing front hub bearing cup, using remover and replacer 41-R-2374-845 and screw 41-S-1047-330.*

- (5) Follow the procedure described in paragraph 207b(4) through (13), and (15).

## **209. Front Brake Drums**

### *a. Removal.*

- (1) Remove the wheel (par. 250a).
- (2) Unscrew and remove the three bolts (fig. 139) securing the brake drum to the hub, and pull the drum from the hub.

### *b. Installation.*

- (1) Place the brake drum on the hub, and align the drum mounting holes with the hub mounting holes. Secure the drum to the hub with three  $\frac{1}{4} \times \frac{3}{8}$  bolts.
- (2) Install the wheel and lower vehicle to ground (par. 250b).

## 210. Front Hubs

### *a. Removal.*

- (1) Follow procedure of paragraph 207*a*(1) through (7).
- (2) Remove the brake drum (par. 209*a*(2)).

### *b. Installation.*

- (1) Install the brake drum on the hub (par. 209*b*(1)).
- (2) Follow procedure of paragraph 207*b*(4) through (13), and (15).

## 211. Hub Bearing Oil Seal

Procedure for removal and installation of the hub bearing oil seal is the same as procedure for removal and installation of the hub bearings (par. 208*b, c, and d*).

## 212. Steering Knuckle Flange Oil Seal Assembly

(fig. 140)

### *a. Removal.*

- (1) Loosen the eight screws securing the two halves of the steering knuckle flange oil seal with retainer assembly to the steering knuckle flange. Remove the screws, lockwashers, and front axle shaft nameplate.

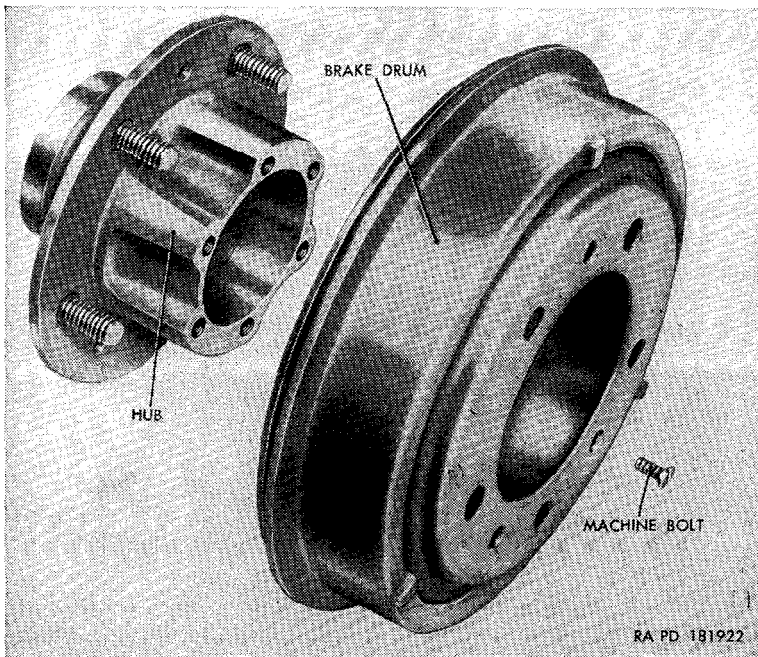

Figure 139. Brake drum—removed from hub.

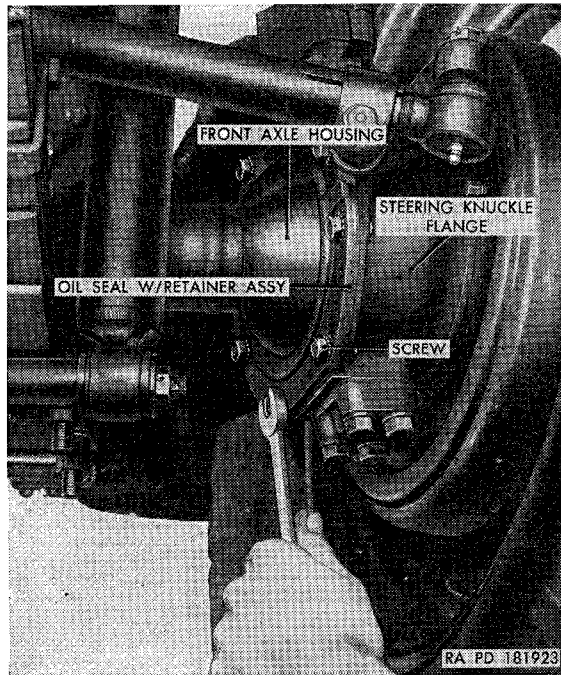

Figure 140. Removing steering knuckle flange oil seal assembly.

- (2) Remove the two halves of the oil seal with retainer assemblies and the steering knuckle flange oil seal gasket from the steering knuckle flange.
- (3) Separate the gasket from the flange. Discard gasket.

*b. Installation.*

- (1) Apply a little grease to the gasket surface of the steering knuckle flange oil seal assembly. Place a new steering knuckle flange oil seal gasket on the steering knuckle flange with the gasket holes alined with the flange holes.
- (2) Place the two halves of the steering knuckle oil seal with retainer assemblies in position against the flange and secure with six  $\frac{5}{16}$ -inch lockwashers and  $\frac{5}{16} \times \frac{5}{8}$  screws.
- (3) Place the front axle shaft nameplate in position over the two upper forward mounting holes in the oil seal and secure to flange with two  $\frac{5}{16}$ -inch lockwashers and  $\frac{5}{16} \times \frac{5}{8}$  screws.

### **213. Steering Knuckle Flange Cap and Bearing Assembly**

*a. Removal.*

- (1) Remove the axle shaft with universal joints assembly (par. 207a).

- (2) Withdraw the cotter pin and unscrew the nut securing the steering tie rod end to the steering knuckle arm (fig. 141).
- (3) Remove the front brake flexible line assembly (par. 236b(1)(a)).
- (4) Unscrew the two machine bolts (T, fig. 134) and remove the bolts, lockwashers, and flexible line guard (U, fig. 134).
- (5) Remove the two remaining bolts and lockwashers, and pry the flange upper cap and shims from the flange.

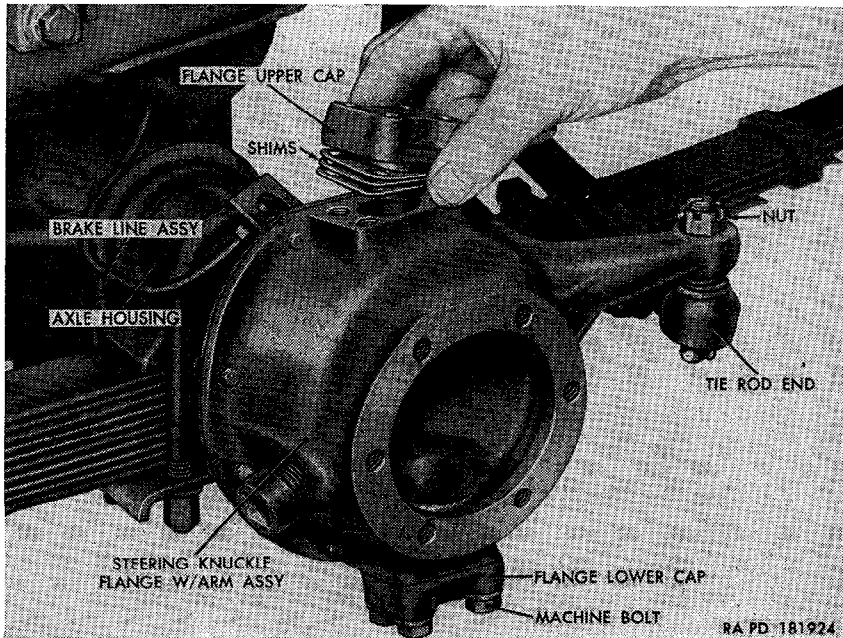

Figure 141. Removing flange upper cap and shims from right steering knuckle flange.

- (6) Loosen the four bolts securing the flange lower cap (fig. 141) to the flange and remove the bolts and lockwashers. Pry the cap from the flange.
- (7) Remove the steering knuckle flange oil seal with retainer assembly (par. 212a).
- (8) Pull the steering knuckle flange off the axle housing and steering tie rod end.
- (9) Lift one bearing cone out of the flange and the other out of the axle housing.
- (10) Position the remover and replacer 41-R-2374-750 and screw 41-S-1047-300 (fig. 142) in the axle housing and drive one steering knuckle flange cap bearing cup out of the housing. Remove the other cup in the same manner.

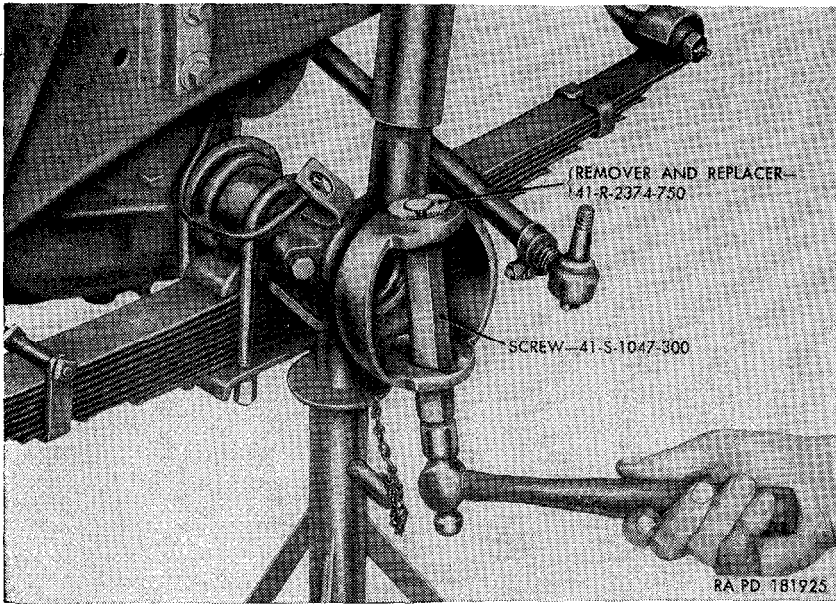

Figure 142. Removing steering knuckle flange bearing cup from front axle housing, using remover and replacer 41-R-2374-750 and screw 41-S-1047-300.

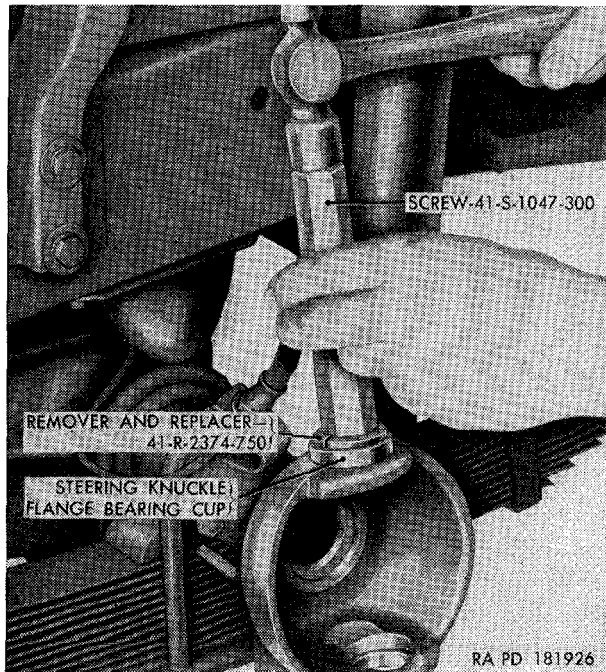

Figure 143. Installing steering knuckle flange bearing cup into front axle housing, using remover and replacer 41-R-2374-750 and screw 41-S-1047-300.

*b. Cleaning and Packing.* Clean the steering knuckle flange cap bearing cups and cones with dry-cleaning solvent or volatile mineral spirits. Pack bearing cones with the grease prescribed in paragraph 69. Keep cones and grease clean.

*c. Installation.*

- (1) Position one steering knuckle flange bearing cup with the small inside diameter of the cup in the axle housing. Place the remover and replacer 41-R-2374-750 (fig. 143) in the cup. Install the screw 41-S-1047-300 (fig. 143) in the remover and replacer and drive the cup into the housing until the outer edge of the cup is flush with the housing. Remove the screw and the remover and replacer. Install the other cup in the same manner.

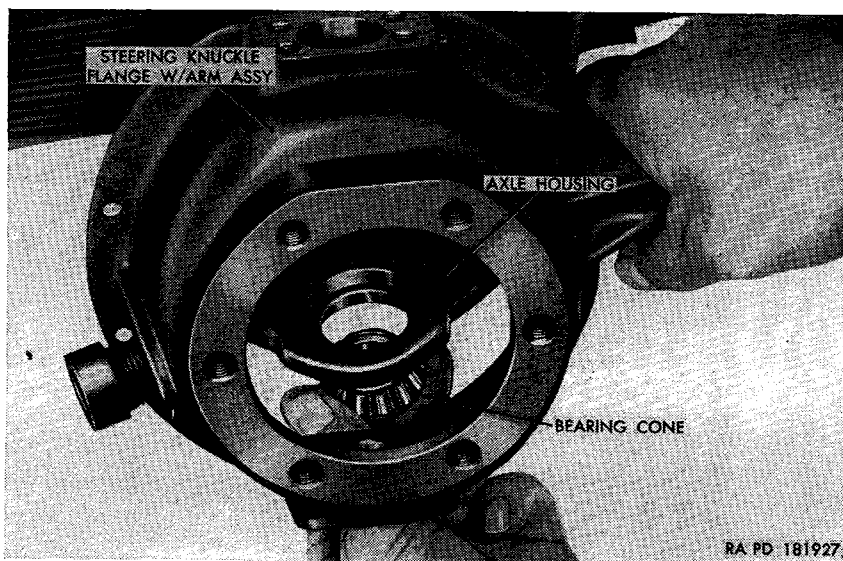
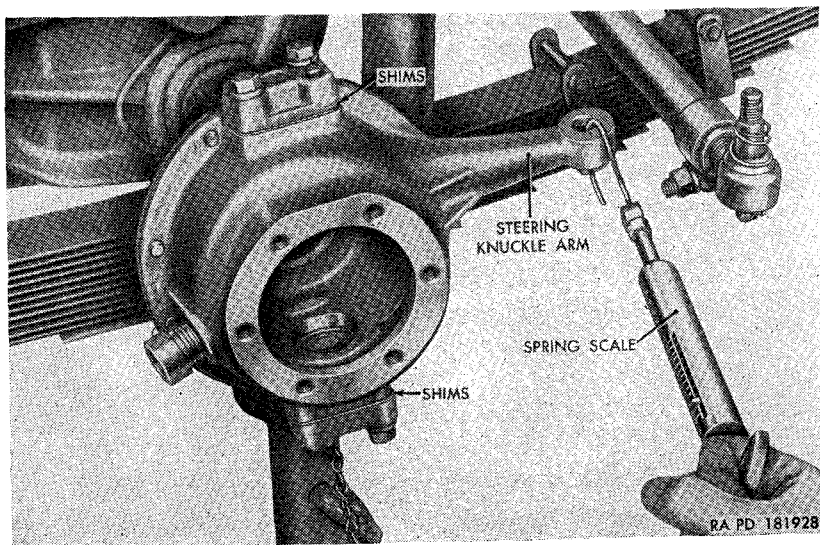

Figure 144. Installing steering knuckle flange and bearing.

- (2) Position a bearing cone in the cup in the upper section of the housing. Position the steering knuckle flange (fig. 144) with arm on the housing. Tilt the flange up and slide the other bearing cone, with the small end of the taper facing up, in from the rear of the flange and between the flange and the housing. Seat the cones in the cups by working the flange up and down.
- (3) Insert flange lower cap (fig. 141) into the lower section of the flange, aligning the cap holes with the flange bolt holes. Secure the cap to the flange with two  $\frac{3}{8}$  x  $1\frac{1}{2}$  bolts and lock-washers.

- (4) Position the flange upper cap, with shims, over the upper section of the flange. Aline the cap and shim holes with the flange bolt holes. Secure the cap and shims to the flange with two  $\frac{3}{8}$  x  $1\frac{1}{2}$  bolts and lockwashers.
- (5) Hook a spring scale in the end of the steering knuckle arm and pull at right angles to the arm. The flange should move with a pull of between 6 to 9 pounds. Install or remove shims until adjustment is correct.
- (6) Install the steering knuckle flange oil seal with retainer assembly (par. 212*b*).
- (7) Position the front brake flexible line guard on the flange cap. Secure the guard to the cap and flange with two  $\frac{3}{8}$  x  $1\frac{1}{8}$  bolts and lockwashers.



*Figure 145. Checking steering knuckle bearing adjustment.*

- (8) Install the tie rod end into the arm of the steering knuckle flange and screw a  $\frac{1}{2}$ -inch slotted nut on the stud of the steering tie rod end. Insert a  $\frac{3}{32}$  x  $\frac{7}{8}$  cotter pin through the stud hole and bend pin over the nut. Install two  $\frac{3}{8}$  x  $1\frac{1}{2}$  bolts and lockwashers in the flange lower cap.
- (9) Install the shaft with universal joints assembly (par. 207*b*).
- (10) Install the front brake flexible line assembly (par. 236*b* (1) (*b*)).
- (11) Bleed the brakes (par. 237).
- (12) Remove the safety stands or blocking and lower the vehicle to the ground.



## 214. Front Axle Assembly

### *a. Removal.*

- (1) Place a jack under the front axle and raise the vehicle until the front tires clear the ground. Place safety stands or suitable blocking under the frame side rails to the rear of the front springs. Leave the jack in position to support the axle during removal.
- (2) Remove both front wheels (par. 250*a*).
- (3) Disconnect the tie rod ends from the right and left steering knuckle arms (par. 225*a*).
- (4) Unscrew the nut from the flexible line that connects the front master cylinder line to the front axle tee (Z, fig. 162). Remove the clip securing the flexible line to the mounting bracket on the engine bracket, located on the frame side rail.
- (5) Remove the universal joint of the propeller shaft from the axle end yoke (par. 202*a*(2)).
- (6) Disconnect the two shock absorbers at the lower end only (par. 247*a*).
- (7) Disconnect the stabilizer bar links (par. 243*a*(2)) on the M170.
- (8) Remove the U-bolt plates from both sides of the vehicle (par. 245*a*(3)).
- (9) Remove the spring pivot bolt from the front end of each front spring (par. 244*a*(3)). Lower the front ends of both springs to the ground.
- (10) Lower the jack and remove the axle assembly from the front of the vehicle.

### *b. Installation.*

- (1) Jack the axle into position and install suitable blocking.
- (2) Raise the front ends of both springs into position and install the pivot bolts (par. 244*b*(1) and (2)).
- (3) Aline the axle over the spring center bolts and install the U-bolt plates (par. 245*b*(3) and (4)).
- (4) Connect the stabilizer bar link (par. 243*b*(5)) on the M170.
- (5) Connect the lower ends of the two shock absorbers.
- (6) Install the universal joint of the propeller shaft in the axle end yoke (par. 202*b*(1)).
- (7) Insert the flexible line fitting end connecting the front master cylinder line to the front axle tee through the bracket hole on the engine bracket on the frame side rail. Drive the clip into the fitting recess. Connect the master cylinder front line to the flexible line by tightening the sleeve nut.
- (8) Insert the steering tie rod end stud into the steering knuckle arm tapered hole and secure in position with a ½-inch

slotted nut and  $\frac{3}{32} \times \frac{7}{8}$  cotter pin. Repeat the procedure for the other side of the vehicle.

- (9) Install both front wheels (par. 250*b*).
- (10) Bleed the brakes (par. 237).
- (11) Remove the safety stands or blocking and lower vehicle to the ground.
- (12) Make a record of replacement on DA Form 478.

## Section XX. REAR AXLE

### 215. Description and Data

*a. Description.* The rear axle assembly includes the housing, differential, shafts, brakes, and hubs and drums. The differential housing is offset to the right of the vehicle to permit a straight line of drive from the transfer to the differential.

*b. Data.*

Manufacturer----- Spicer Mfg Corp  
Drive gear ratio----- 5.38 to 1  
Drive----- (Hotchkiss) through springs  
Type----- semifloating

### 216. Rear Axle Shafts

*Note.* The removal and installation procedures described in this paragraph apply to either left or right axle shafts.

*a. Removal.*

- (1) Remove the wheel (par. 250*a*).
- (2) Pry off the hub cap and remove the cotter pin, shaft nut, and shaft washer (fig. 146).
- (3) Using a suitable puller, pull the hub, drum, and key from the shaft.
- (4) Unscrew the nut securing the brake line (fig. 147) to the brake wheel cylinder and pull the line free.
- (5) Remove the six lockwasher nuts from the bolts in the housing flange. Remove the grease slinger, grease slinger gasket, outer oil seal, and oil seal gasket (fig. 147).
- (6) Pull the backing plate with brake shoe assemblies from the axle housing.
- (7) Remove the bearing retainer and shims from the bolts in the housing flange, and remove the bolts.
- (8) Using a suitable puller, pull the shaft with bearing cup and cone from the axle housing (fig. 148). Pry the inner oil seal out of the housing. Discard oil seal.
- (9) Pull the cup off the cone with a suitable remover. Remove the cone from the shaft.

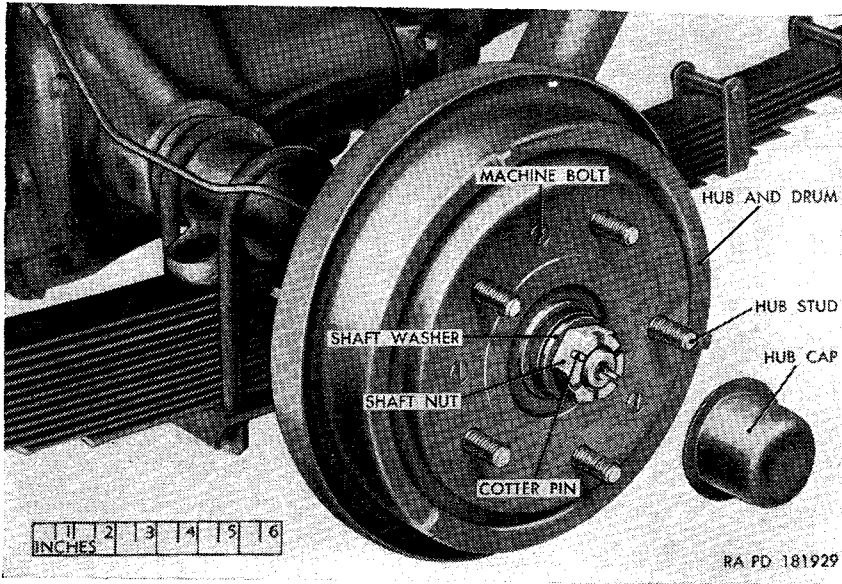

Figure 146. Rear axle with brake, hub, and drum assemblies—hub cap removed.

*b. Cleaning and Packing.* Clean bearing cones with dry-cleaning solvent or volatile mineral spirits. Pack bearing cones with grease as prescribed in paragraph 69. Keep cones clean.

*c. Installation.*

- (1) Drive a new inner oil seal, with lip inward, into the housing until the seal seats.

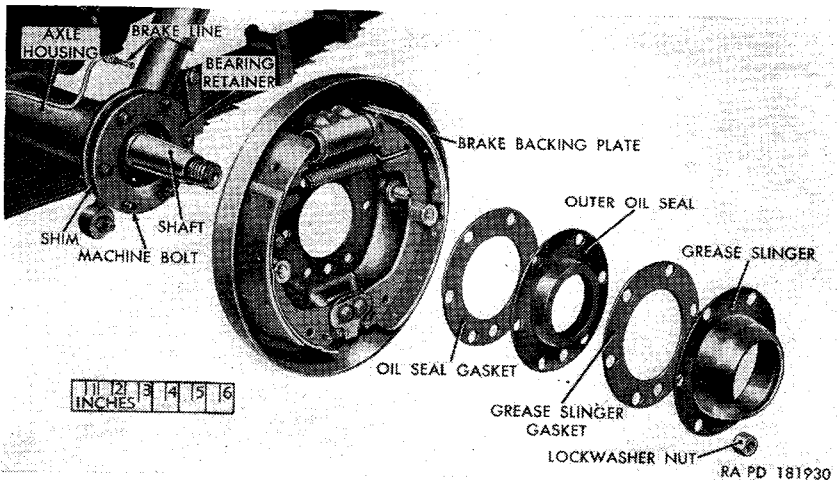
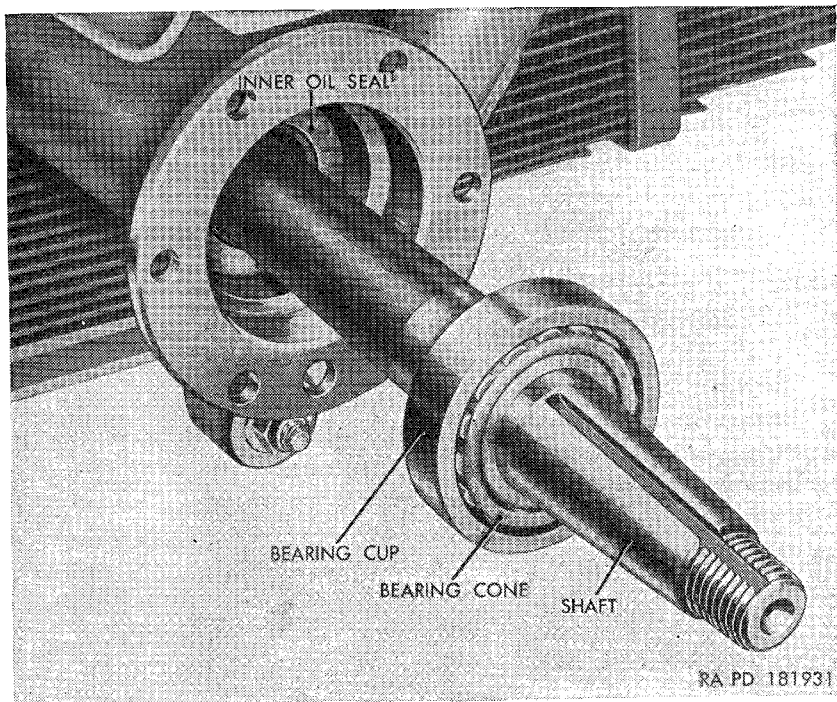

Figure 147. Rear axle and brake backing plate with brake shoe assemblies—partially exploded view.

- (2) Place the bearing cone, with small end of taper facing out, on the shaft tapered end and force the cone against the shaft shoulder.
- (3) Insert the shaft with cone into the axle housing. Rotate the shaft to align the splines and push the shaft into the differential.
- (4) Install the bearing cup over the cone and tap the cup until it is well started into the housing.



*Figure 148. Rear axle shaft with bearing assembly—partially withdrawn from housing.*

- (5) Position the shims and bearing retainer (fig. 147) over the shaft, aligning the retainer and shim drain holes with the housing drain hole. Insert three  $\frac{3}{8}$  x  $1\frac{1}{4}$  bolts through alternate holes in the housing, shims, and retainer.
- (6) Position the backing plate with brake shoe assemblies against the bearing retainer with the plate drain hole aligned with the bearing retainer and housing drain hole.
- (7) Position the oil seal gasket, the outer oil seal, the grease slinger gasket, and the grease slinger on the backing plate, with the drain hole in each aligned with the drain hole in the plate. Insert the remaining three  $\frac{3}{8}$  x  $1\frac{1}{4}$  bolts through

- the holes in the axle housing and positioned parts. Place six  $\frac{3}{8}$  lockwasher nuts on the bolts and tighten the nuts.
- (8) Connect the brake line to the brake wheel cylinder,
  - (9) Place the hub and drum (fig. 146) on the shaft, with the hub keyway alined with the shaft keyway. Insert the key into the keyway and tap the key and hub and drum into position on the shaft.
  - (10) Place the shaft washer on the shaft, screw the shaft nut on the end of the shaft and secure the nut with a  $\frac{1}{8}$  x  $1\frac{1}{2}$  cotter pin.
  - (11) Install the wheel (par. 250*b*), and lower the vehicle to the ground. Bleed the brakes (par. 237).

## 217. Rear Axle Shaft Bearings

The procedure for the removal and installation of the rear axle shaft bearings is the same as the procedure for the removal and installation of the rear axle shafts described in paragraph 216.

## 218. Oil Seals

### *a. Outer Oil Seal Assembly.*

- (1) *Removal.* Remove the outer oil seal assembly (par. 216*a*(1), (2), (3), and (5)).
- (2) *Installation.* Position the oil seal gasket, outer oil seal assembly, the grease slinger gasket, and the grease slinger on the bolts projecting through the housing and backing plate, with the drain hole in each alined with the drain hole in the plate. Place six  $\frac{3}{8}$ -inch lockwasher nuts on the bolts and tighten the nuts. Complete the installation by following the procedure in paragraph 216*c*(9), (10), and (11).

### *b. Inner Oil Seal Assembly.*

- (1) *Removal.* Follow procedure in paragraph 216*a*(1) through (8).
- (2) *Installation.* Follow procedure in paragraph 216*c*(1), and (3) through (11).

## 219. Rear Brake Drums

### *a. Removal.*

- (1) Remove the wheel (par. 250*a*).
- (2) Remove the three bolts (figs. 139 and 146) securing the drum to the hub, and pull the drum from the hub (fig. 139).

### *b. Installation.*

- (1) Position the drum (fig. 139) on the hub, alining the drum mounting holes with those in the hub. Secure the drum to the hub with three  $\frac{1}{4}$  x  $\frac{5}{8}$  bolts.
- (2) Install the wheel (par. 250*b*).

## 220. Rear Hubs

### *a. Removal.*

- (1) Follow the procedure of paragraph 216a(1), (2), and (3).
- (2) Remove the drum from the hub (par. 219a(2)).
- (3) If it is necessary to replace any hub studs, drive them out of the hub.

### *b. Installation.*

- (1) If any hub studs were removed, drive new studs into the hub, using studs with left-hand threads in hubs on the left side of vehicle, and studs with right-hand threads on the right side of the vehicle.
- (2) Install the brake drum (par. 219b(1)).
- (3) Follow procedure of paragraph 216c(9), (10), and (11).

## 221. Rear Axle Assembly

### *a. Removal.*

- (1) Remove both rear wheels (par. 250a). Install suitable blocking under both frame side rails in front of the rear springs. Leave the jack in position to support the axle during removal.
- (2) Unscrew the nut on the master cylinder rear line (J, fig. 162) from the flexible line. Remove the clip securing the end of the flexible line to the bracket on the frame cross member.
- (3) Remove the universal joint of the propeller shaft from the rear axle end yoke (par. 203a(1)).
- (4) Disconnect the stabilizer bar links (par. 243a(2)) on the M170.
- (5) Remove the four U-bolt nuts and lockwashers from the two U-bolts (fig. 165) securing the U-bolt plate and spring to the axle housing and remove the U-bolts. Swing the lower end of the shock absorber, with U-bolt plate (fig. 165), toward the front of the vehicle. Repeat this procedure on the other side of the vehicle.
- (6) Remove the spring shackles from both rear spring assemblies (par. 242a(2) and (3)). Lower the ends of the springs to the ground.
- (7) Remove all brake lines, connections, and fittings by following the procedure of paragraph 236.

*b. Installation.* Any parts not supplied with a new axle should be removed from the old axle.

- (1) Install all brake lines, connections, and fittings on the axle assembly (par. 236).
- (2) Position the axle assembly between the rear springs and frame.

- (3) Raise the ends of the springs, making certain that each spring center bolt enters the spring saddle recess. Install spring shackles (par. 242*b*(1), (2) and (3)).
- (4) Swing the lower end of one shock absorber, with **U**-bolt plate, toward the rear and under the axle. Install two **U**-bolts (fig. 165) over the housing and through the plate and secure with four  $\frac{7}{16}$ -inch lockwashers and  $\frac{7}{16}$ -inch **U**-bolt nuts (fig. 165). Repeat on the other side of the vehicle.
- (5) Connect the stabilizer bar links (par. 243*b*(5)) on the M170.
- (6) Connect the universal joint of the propeller shaft to the rear axle end yoke (par. 203*b*(2)).
- (7) Insert the end of the flexible line rear axle tee-to-master cylinder rear line (H, fig. 162) through the bracket on the frame cross member. Push the spring clip into the groove on the end of the flexible line. Insert the rear master cylinder line end into the flexible line end and tighten the nut.
- (8) Bleed the brakes (par. 237).
- (9) Install both rear wheels (par. 250*b*). Remove the blocking and lower the vehicle to the ground.
- (10) Make a record of replacement on DA Form 478.

## Section XXI. STEERING SYSTEM

### 222. Description and Data

*a. Description.* The steering system consists of the steering wheel, steering gear, Pitman arm, steering drag link, bellcrank, and two tie rods with ends. Except for the steering wheel and shaft jacket, the entire steering system is shown in figure 149. The steering gear is the cam and twin-pin levertype, and carries a conventional Pitman arm. The drag link is the conventional ball- and socket-type with spring-loaded adjustment. The bellcrank assembly includes needle bearings between the bellcrank and bellcrank shaft. The right tie rod with ends connects the bellcrank to the right steering knuckle arm. The left tie rod with ends connects the left end of the right tie rod to the left steering knuckle arm.

#### *b. Data.*

##### Steering gear :

Manufacturer.....	Ross Gear and Tool Co.
Model.....	TL-130005
Type.....	cam and twin-pin lever
Ratio.....	variable high point-type

##### Steering geometry :

King pin inclination.....	$7\frac{1}{2}^{\circ}$
Wheel camber.....	$1\frac{1}{2}^{\circ}$
Wheel caster.....	$3^{\circ}$
Wheel toe-in.....	$\frac{3}{32}$ to $\frac{3}{16}$ in.

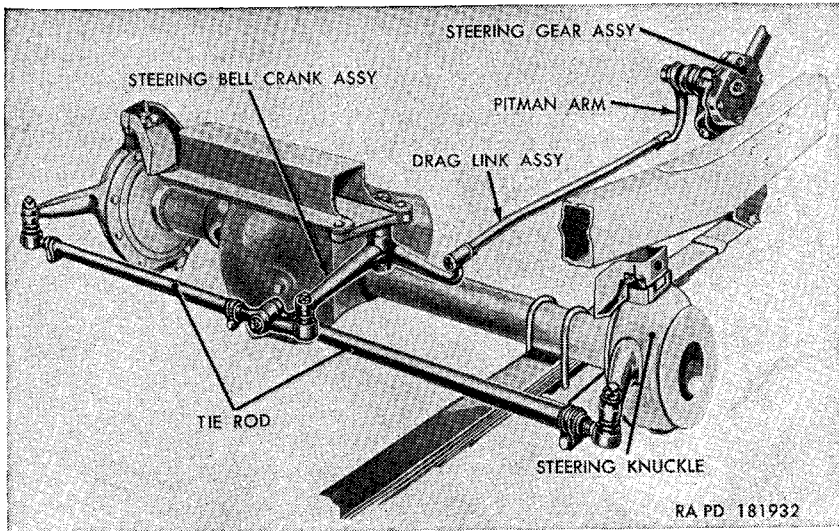

Figure 149. Steering system linkage.

## 223. Organizational Maintenance

Organizational maintenance consists of lubrication (par. 69), periodic inspection (par. 71), and toe-in adjustment (par. 224), as required. Any operation involving correction of steering geometry (except toe-in) is the responsibility of the ordnance maintenance unit.

## 224. Toe-In Adjustment

Loose hub bearings, worn bushings in steering knuckle supports, damaged wheels and bent steering knuckles, a bent axle housing, or a bent or improperly adjusted tie rod will affect toe-in. Inspect and correct or notify ordnance maintenance personnel if any damaged units are found.

*a.* Inflate tires to correct pressure (par. 248*b*), and check for proper front hub bearing adjustment (par. 208*a*). With the vehicle on a smooth level surface, turn the steering wheel until the steering bell-crank is at right angles to the front axle. Place a straightedge or line against the outside of the left wheels; check to make certain that the left front wheel is in line with or straightahead of the left rear wheel. If not, loosen the nuts and screws on the clamps of the ends of the left tie rod with ends assembly, and turn the tie rod to obtain a straight-ahead position. After adjustment is completed, tighten clamps on ends of tie rods. Repeat the procedure to check the right front wheel. Use right tie rod to adjust right front wheel.

*Note.* The right ends of both tie rod with ends assemblies have right-hand threads; the left ends of both assemblies have left-hand threads.

*b.* After both wheels are in straightahead position, place toe-in adjustment gage between the wheels ahead of the axle, with the ends of



the gage bearing against the tire side walls and with both pendant chains (fig. 150) just touching the ground. Set gage so pointer registers zero. Move vehicle forward until gage is brought into position in back of axle, with both pendant chains (fig. 151) just touching the ground. The pointer will indicate the amount of toe-in or toe-out. Correct toe-in is  $+\frac{1}{8} \pm \frac{1}{16}$  inch.

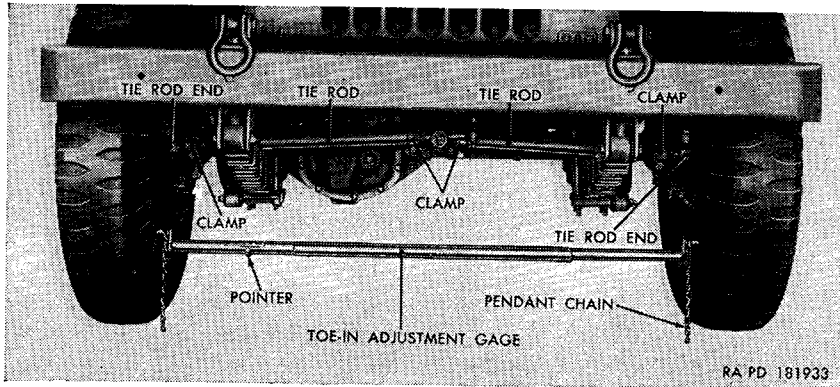

Figure 150. Toe-in adjustment—gage in forward position.

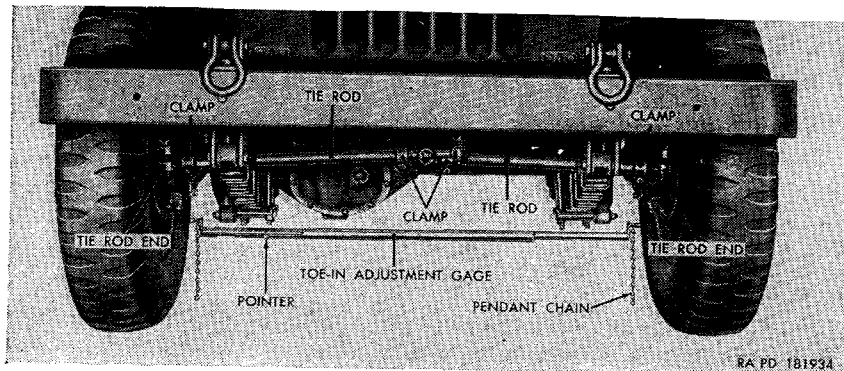

Figure 151. Toe-in adjustment—gage in rear position.

c. If toe-in is not correct, loosen the nuts and screws on the clamps of the ends of the right tie rod with ends assembly and turn the tie rod to obtain correct adjustment. Make sure that clamp nuts and screws are retightened after adjustment has been made.

## 225. Tie Rod With Ends Assemblies

(fig. 152)

### a. Removal.

- (1) Place the vehicle on a level surface and apply the hand brake.
- (2) Remove the cotter pin and nut securing the left tie rod with ends assembly to the right tie rod with ends assembly.

- (3) Using a suitable puller, separate the two tie rod ends.

*Note.* Do not hammer on the tie rod ends.

- (4) Remove the cotter pin and nut securing the left tie rod with ends assembly to the left steering knuckle arm.
- (5) Using a suitable puller, separate the tie rod end from the arm.
- (6) Remove the cotter pin and nut securing the right tie rod with ends assembly to the steering bellcrank.
- (7) Using a suitable puller, separate the tie rod end from the bellcrank.

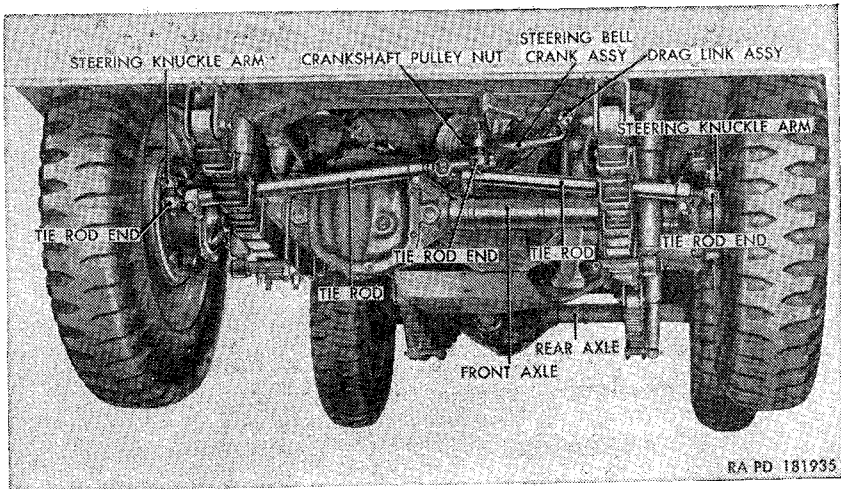

*Figure 152. Tie rod with end assemblies—installed.*

- (8) Remove the cotter pin and nut securing the right tie rod with ends assembly to the right steering knuckle arm.
  - (9) Using a suitable puller, separate the tie rod end from the arm.
- b. Installation.*
- (1) Position the right end of the right tie rod with ends assembly in the right steering knuckle arm and secure with a  $\frac{1}{2}$ -inch slotted nut and  $\frac{3}{32} \times \frac{7}{8}$  cotter pin.
  - (2) Position the left end of the right tie rod with ends assembly in the steering bellcrank and secure with a  $\frac{1}{2}$ -inch slotted nut and  $\frac{3}{32} \times \frac{7}{8}$  cotter pin.
  - (3) Position the left end of the left tie rod with ends assembly in the left steering knuckle arm and secure with a  $\frac{1}{2}$ -inch nut and  $\frac{3}{32} \times \frac{7}{8}$  cotter pin.
  - (4) Position the right end of the left tie rod with ends assembly in the left end of the right tie rod with ends assembly. Secure with a  $\frac{1}{2}$ -inch slotted nut and  $\frac{3}{32} \times \frac{7}{8}$  cotter pin.
  - (5) Adjust the toe-in (par. 224).

## 226. Tie Rod Ends

a. *General.* The right ends of both tie rod with ends assemblies have right hand threads; the left ends of both assemblies have left-hand threads. With this exception, the removal and installation of all tie rod ends are the same. The following procedure refers to the right end of the right tie rod with ends assembly.

### b. *Removal.*

- (1) Remove the right end of the right tie rod with ends assembly from the right steering knuckle arm (par. 225a(8) and (9)).
- (2) Loosen the bolt and nut in the clamp of the tie rod end.
- (3) Unscrew and remove the end with clamp from the tie rod.
- (4) Slip the clamp off the tie rod end.

### c. *Installation.*

- (1) Place the clamp on the tie rod end.
- (2) Screw the end with clamp on the tie rod.
- (3) Install the right end of the right tie rod with ends assembly in the right steering knuckle arm (par. 225b(1)).
- (4) Adjust the toe-in (par. 224).

## 227. Drag Link Assembly

*Note.* The key letters noted in parentheses are in figure 153, except where otherwise indicated.

### a. *Removal.*

- (1) Remove the cotter pin (A) from the axle end of the drag link assembly (fig. 149). Unscrew, but do not remove, the axle end ball seat adjusting plug (B). Lift the drag link assembly off the ball of the bellcrank.
- (2) Remove the cotter pin (A) from the steering gear end of the drag link assembly (fig. 149). Unscrew, but do not remove,

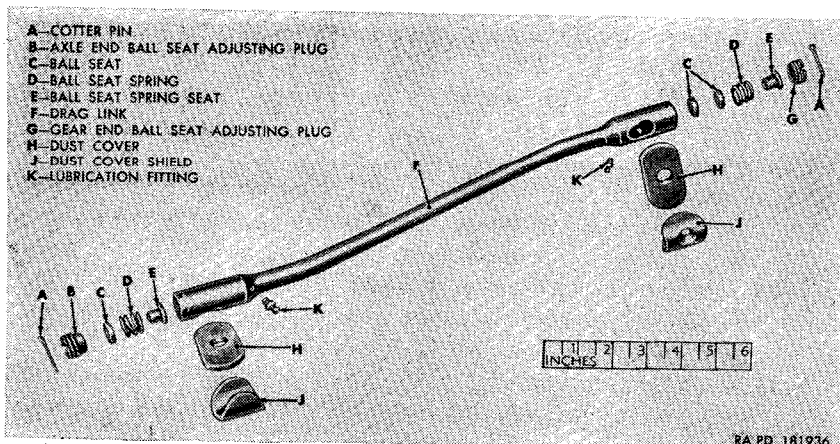

Figure 153. Drag link assembly—exploded view.

the gear end ball seat adjusting plug (G). Lift the drag link assembly off the ball of the Pitman arm.

*b. Disassembly.*

- (1) Unscrew and remove the axle end ball seat adjusting plug (B). Remove, in order, ball seat (C), ball seat spring (D), and the ball seat spring seat (E).
- (2) Unscrew and remove the gear end ball seat adjusting plug (G). Remove, in order, the ball seat spring seat (E), the ball seat spring (D), and two ball seats (C).
- (3) Remove the dust cover (H) and the dust cover shield (J) from the ball on the Pitman arm. Remove the other dust cover (H) and dust cover shield (J) from the ball on the steering bellcrank.
- (4) Remove the two lubrication fittings (K).

*c. Assembly.*

- (1) Install a dust cover shield (J) and dust cover (H) over the ball of the steering bellcrank and over the ball of the Pitman arm.
- (2) Install in order in the gear end of the drag link, two ball seats (C), ball seat spring (D), ball seat spring seat (E), and gear end ball seat adjusting plug (G).

**Note.** The ball opening on the axle end of the drag link is closer to the end of the link than is the ball opening on the gear end of the link.

- (3) Install in order in the axle end of the drag link ball seat spring seat (E), ball seat spring (D), ball seat (C), and the axle end ball seat adjusting plug (B).
- (4) Install two  $\frac{1}{8}$ -inch NPT lubrication fittings (K) into drag link.

*d. Installation.*

- (1) Position the gear end of the drag link assembly over the ball of the Pitman arm (fig. 149), making certain that the ball enters between the two ball seats (C). Tighten the gear end ball seat adjusting plug (G). Back off the plug one-quarter turn and until one of the slots is aligned with the holes in the drag link, and install a  $\frac{1}{8} \times 1\frac{3}{4}$  cotter pin (A) and spread pin ends.
- (2) Position the axle end of the drag link assembly over the ball on the steering bellcrank (fig. 149), making certain that the ball enters between the ball seat (C) and the ball seat spring (D). Tighten the axle end ball seat adjusting plug (B). Back off the plug one-half turn and until one of the slots is aligned with the holes in the drag link and install a  $\frac{1}{8} \times 1\frac{3}{4}$  cotter pin (A) and spread pin ends.

## 228. Steering Bellcrank

### *a. Removal.*

- (1) Disconnect the right tie rod with ends assembly from the bellcrank (par. 225a(6) and (7)).
- (2) Disconnect the steering drag link assembly from the bellcrank (par. 227a(1)).
- (3) Remove the self-locking nut and plain washer from the top of the bell crankshaft.
- (4) Loosen the nut and screw in the bellcrank bracket.
- (5) Lower the bellcrank shaft and bellcrank out of the bracket.

*Note.* The bearing inner race spacer will come out with the shaft.

### *b. Installation.*

- (1) Position the bellcrank assembly against the bellcrank bracket and insert the bellcrank shaft, with bearing inner race spacer, through the bellcrank and bracket.
- (2) Secure the shaft in the bellcrank with a  $2\frac{1}{32}$ -inch ID plain washer and  $\frac{5}{8}$ -inch self-locking nut.
- (3) Tighten the nut and clamp screw in the bracket.
- (4) Connect the drag link assembly to the bellcrank (par. 227d(2)).
- (5) Connect the right tie rod with ends assembly to the bellcrank (par. 225b(2)).
- (6) Lubricate the bellcrank shaft (par. 69).

## 229. Steering Wheel

### *a. Removal.*

- (1) Pry the horn button cap from the steering wheel nut.
- (2) Pull the horn button, with horn switch push rod, out of the steering gear shaft. Unscrew and remove the steering wheel nut from the shaft.
- (3) Using puller and adapter 41-A-18-251 (fig. 154), pull the steering wheel from the steering gear shaft.

### *b. Installation.*

- (1) Place front wheels in a straightahead position.
- (2) Position the steering wheel on the steering gear shaft, with one spoke straightforward. With a soft mallet, tap the wheel onto the shaft. Screw the steering wheel nut onto the steering gear shaft threads.
- (3) Insert the horn switch push rod, with horn button, into the shaft. Make certain that the lower end of the push rod seats in the oil seal tube at the bottom of the steering gear.
- (4) Stretch the horn button cap over the steering wheel nut.

## 230. Steering Gear Assembly

### *a. Adjustment.*

- (1) Jack up the vehicle until the front tires are clear of the ground. Turn the steering wheel (fig. 154) to the right or left to position the wheels in a straightahead position. Mark the steering wheel at the top and place a mark on the windshield in line with the mark on the wheel.
- (2) Disconnect the drag link assembly from the Pitman arm (par. 227a(2)).

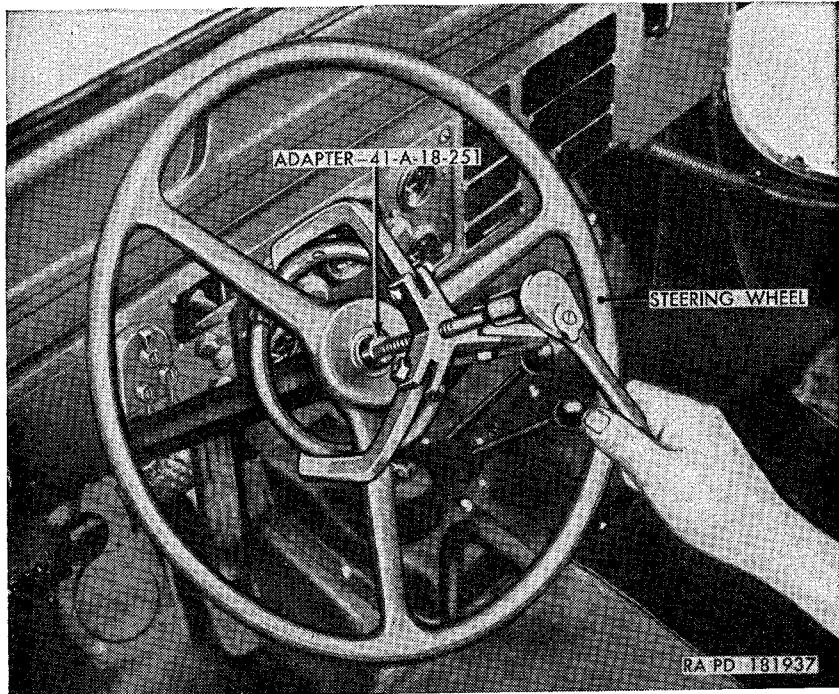

Figure 154. Removing steering wheel from steering gear shaft, using puller and adapter—41-A-18-251.

- (3) Loosen the Pitman shaft adjusting screw jam nut (fig. 155) and tighten the Pitman shaft adjusting screw. Back off on the adjusting screw one-half turn and tighten the jam nut.
- (4) Turn the steering wheel one-half turn to the right and then back to the left. As the mark on the wheel passes the mark on the windshield, a slight drag should be felt. If no drag is felt, repeat the adjustment ((3) above), backing off the adjusting screw less than one-half turn.
- (5) Connect the drag link assembly to the Pitman arm (par. 227b(1)).

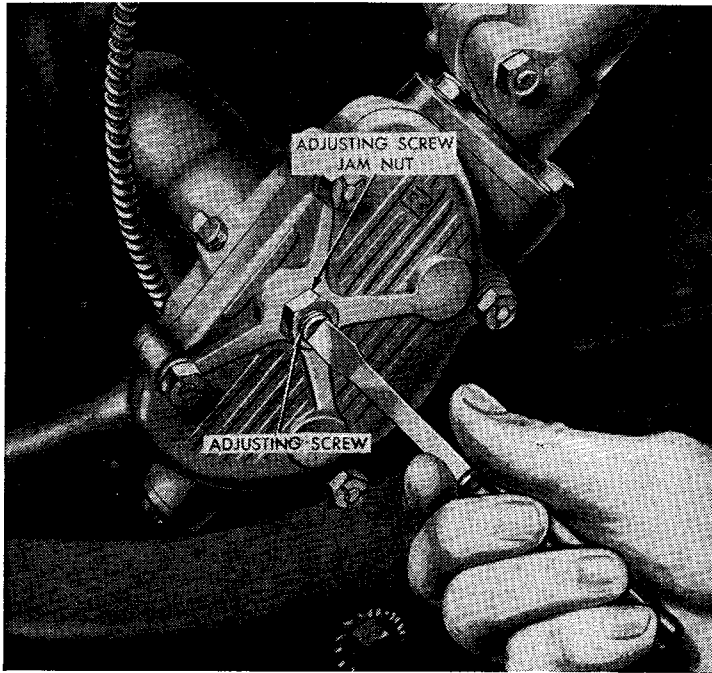

Figure 155. Pitman arm shaft adjustment.

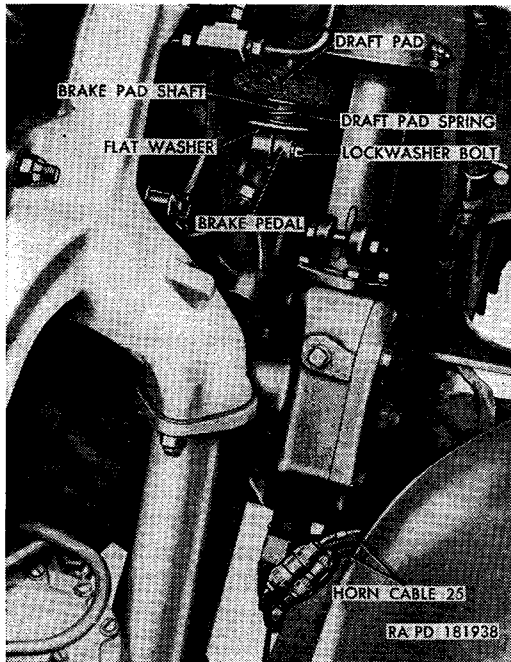

Figure 156. Disconnect points for steering gear removal—engine compartment.

- (6) Turn the steering wheel and check all steering linkage.  
Lower the vehicle to the ground.

*b. Removal.*

- (1) Removal the steering wheel assembly (par. 229a).
- (2) Disconnect the steering drag link assembly from the Pitman arm (par. 227a(2)).
- (3) Disconnect the two horn cables 25 at the connectors (H, fig. 161).
- (4) Remove the brake master cylinder shield (par. 234b(1)).
- (5) Remove the lockwasher bolt from the brake pedal and pad assemblies (fig. 156) and detach the pad assembly from the pedal.
- (6) Slide the draft pad spring, flat washer, and draft pad (fig. 156) off the bottom of the draft pad assembly shaft, and pull the assembly out of the upper front floor pan cover.
- (7) Remove the cotter pin and flat washer securing the throttle rod adjusting block (B, fig. 55) to the accelerator lower bellcrank with bushing assembly (A, fig. 55) and remove the block from the bellcrank. Pull the link rod (C, fig. 55) up through the upper front floor pan cover.
- (8) Remove the four lockwasher screws securing the brake master cylinder inspection cover (fig. 157) to the upper front floor pan, and remove the cover from the pan.
- (9) Remove the two lockwasher screws securing the steering gear jacket access plate (fig. 157) to the body, and remove the plate.
- (10) Remove the 10 lockwasher screws securing the upper front floor pan cover to the body, and lift the cover from the vehicle.
- (11) Remove the three plain nuts, six internal-external-teeth lock washers, and three steering gear mounting bolts (F, fig. 161) securing the steering gear and Pitman arm assembly to the vehicle frame.
- (12) While supporting the steering gear with Pitman arm assembly, remove the two plain nuts and two lockwasher bolts from the mounting tube jacket-to-instrument panel clamp (fig. 157). Detach the clamp and gasket from the instrument panel.
- (13) Work the steering gear with pitman arm assembly out of the vehicle through the driver's compartment.
- (14) Remove the plain nut and lockwasher from the Pitman shaft. Scribe alinement marks on the Pitman arm and Pitman shaft. Using a wedge-type remover, separate the Pitman arm from the Pitman shaft.

**Caution:** Do not drive remover too deep, as damage can be done to shaft serrations.



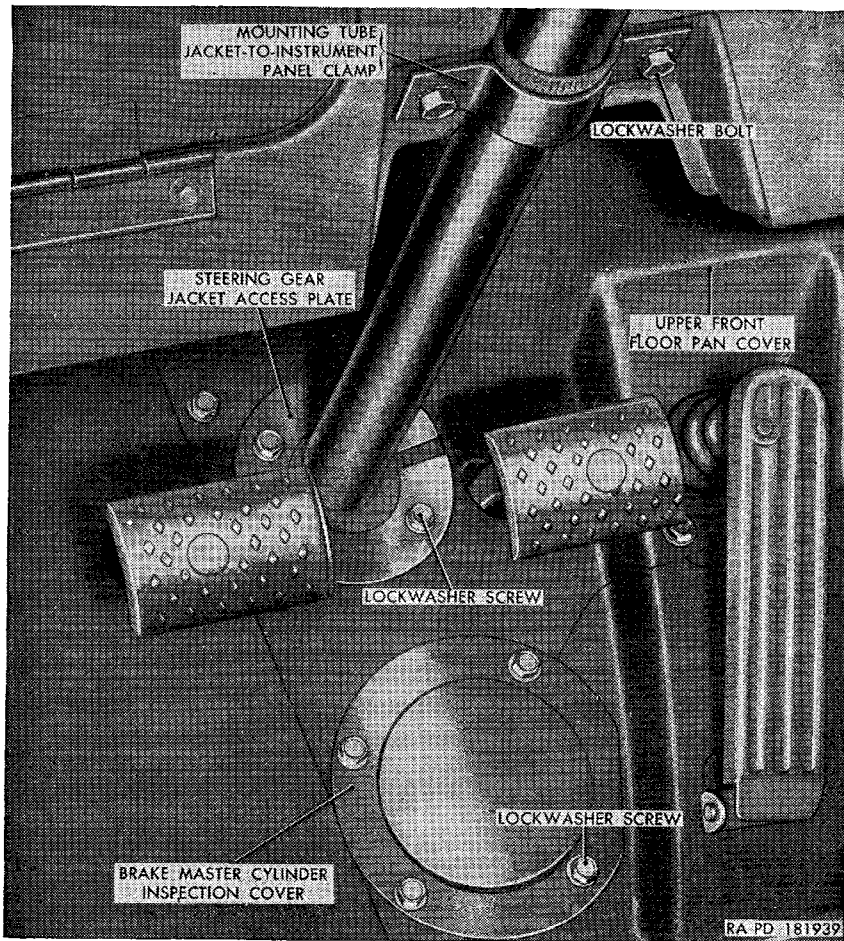

Figure 157. Disconnect points for steering gear removal—driver's compartment.

*c. Installation.*

- (1) Position the Pitman arm on the Pitman shaft with the arm scribe marks aligned with the Pitman shaft. Tap the arm onto the shaft and secure with a  $\frac{3}{4}$ -inch lockwasher and  $\frac{3}{4}$  x 2 plain nut.

*Note.* If Pitman arm or Pitman shaft does not have a match mark, set the steering gear shaft in midposition. To place shaft in midposition, rotate shaft to right as far as possible and then in opposite direction as far as possible, noting total number of turns. Turn shaft back one-half number of total turns. Position arm on Pitman shaft so arm is perpendicular to long side of gear housing.

- (2) Lower the steering gear with Pitman arm assembly into approximate position through the driver's compartment.
- (3) Aline the mounting tube jacket-to-instrument panel clamp (fig. 157) and gasket with the holes in the panel. Attach

- clamp to panel with two  $\frac{5}{16} \times \frac{7}{8}$  lockwasher bolts and two  $\frac{5}{16}$ -inch plain nuts. Do not tighten the nuts.
- (4) Align the steering gear housing holes with vehicle frame holes. Secure the steering gear to the frame with three  $\frac{7}{16} \times 3$  steering gear mounting bolts (F, fig. 161), six  $\frac{7}{16}$ -inch internal-external-teeth lockwashers, and three  $\frac{7}{16}$ -inch plain nuts. Tighten the nuts in the mounting tube jacket-to-instrument panel clamp.
  - (5) Connect the two horn cables 25 (fig. 156) at the connectors at the bottom of the steering gear on the left side of the engine compartment.
  - (6) Install the brake master cylinder shield (par. 234c(8)).
  - (7) Make certain that the underside of the upper front floor pan cover (fig. 157) edges are coated with permagum seal 7348567. Position the cover in the driver's compartment with the cover holes aligned with the body holes. Secure the cover to the body with ten  $\frac{1}{4} \times \frac{5}{8}$  lockwasher screws.
  - (8) Make certain that the underside of the steering gear jacket access plate edges are coated with permagum seal 7348567. Position the plate with the plate holes aligned with the body holes. Secure with two  $\frac{1}{4} \times \frac{5}{8}$  lockwasher screws.
  - (9) Make certain that the underside of the brake master cylinder inspection cover edges are coated with permagum seal 7348567. Position the inspection cover on the upper front floor pan cover and secure with four  $\frac{1}{4} \times \frac{5}{8}$  lockwasher screws.
  - (10) From the driver's compartment, insert the brake pad assembly shaft through the upper front floor pan cover from the underside of the cover, slip the draft pad (fig. 156), flat washer, and draft pad spring on the shaft. Insert the shaft into the clamp on end of brake pedal and secure with a  $\frac{5}{16} \times 1\frac{1}{4}$  lockwasher bolt.
  - (11) Insert the accelerator bellcrank link through the upper front floor pan cover. Install the throttle rod adjusting block (B, fig. 55) on the accelerator lower bellcrank with bushing assembly (A, fig. 55). Secure block to bellcrank with one No. 8 flat washer and  $\frac{1}{16} \times \frac{1}{2}$  cotter pin.
  - (12) Connect the drag link to the Pitman arm (par. 227d(1)).
  - (13) Install the steering wheel (par. 229b).
  - (14) Adjust the steering gear (*a* above).

## Section XXII. BRAKE SYSTEMS

### 231. Description and Data

*a. Description.* The service or foot brake system (fig. 162) is of the hydraulic-type with brakes for all four wheels. Each brake

has two shoes. Adjustments are provided to compensate for brake lining wear. The service brake pedal (fig. 158) operates a piston in the master cylinder to force brake fluid through the brake lines to the wheel cylinders which actuate the brakes. The hand brake (fig. 163) is located at the rear of the transfer and is normally used to hold the vehicle in position when parked. The hand brake can also be used to stop the vehicle in cases of emergency or failure of the service brakes. The hand brake handle (W, fig. 12), for operating the brake, is located between the two front seats. Pulling up on the handle forces the brake shoes against the brake drum.

*b. Data.*

Service brakes :

Type----- Hydraulic  
 Size----- 9 x 1 $\frac{3}{4}$  in.  
 Fluid capacity-----  $\frac{1}{2}$  pt

Master cylinder :

Type----- reservoir and cylinder  
 Size :  
 Front----- 1 in.  
 Rear-----  $\frac{3}{4}$  in.

Brake shoes :

Lining length—forward shoe (moulded)----- 10 $\frac{7}{32}$  in.  
 Lining length—rear shoe (moulded)----- 6 $\frac{39}{64}$  in.  
 Width----- 1 $\frac{3}{4}$  in.  
 Thickness-----  $\frac{7}{32}$  in.

Hand brake :

Type----- mechanical, internal-external clamping  
 Width----- 1 $\frac{1}{2}$  in.  
 Thickness-----  $\frac{5}{32}$  in.

## 232. Organizational Maintenance

It is the responsibility of the using organization to maintain correct fluid level in the brake master cylinder (par. 69), bleed brake system (par. 237), adjust the free travel of the service brake pedal (par. 233*a*), adjust service brake shoes (par. 233*b*), adjust hand brake (par. 238*a*), replace service brake shoes with linings assemblies (par. 233*c* and *d*), replace hand brake shoes with lining assembly (par. 238*b* and *c*), replace brake master cylinder (par. 234), replace wheel cylinders (par. 235), replace brake drums (par. 209), and to replace lines and fittings (par. 236).

## 233. Service Brakes

*a. Service Brake Pedal Free Travel Adjustment* (fig. 158). Correct service brake pedal free travel adjustment insures that the service brakes will be fully released, when the brake pedal has returned from the depressed position.

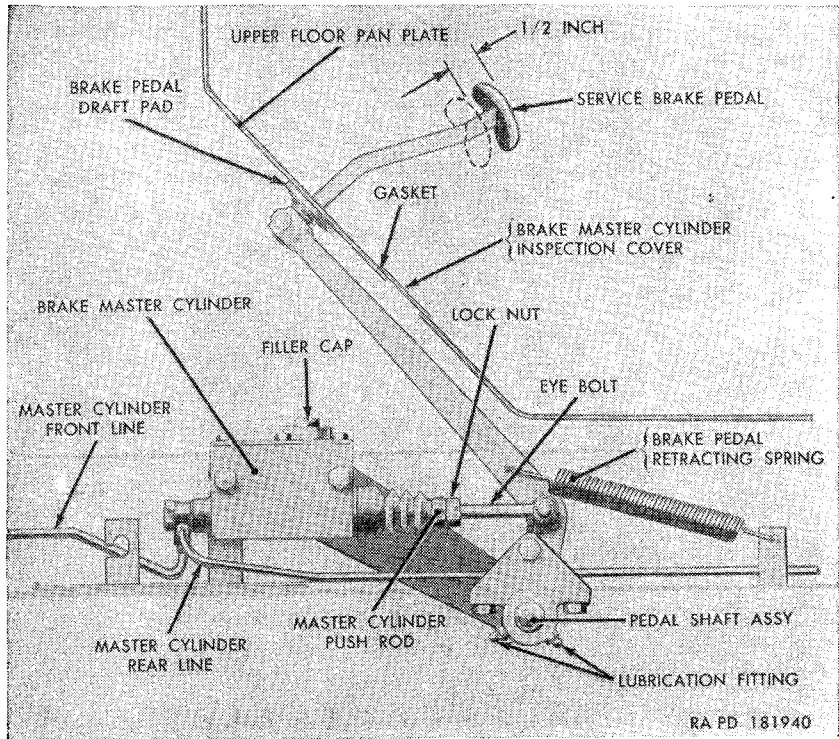

Figure 158. Service brake pedal and brake master cylinder linkage.

- (1) Make certain the pedal shaft assembly is lubricated and the brake pedal retracting spring is undamaged and properly connected.
- (2) Hold a rule next to the brake pedal and depress the pedal by hand. No resistance should be felt until the pedal has traveled one-half inch. If distance traveled before resistance is felt is incorrect, adjust as shown in (3) below.
- (3) Loosen the locknut on the eye bolt and turn the master cylinder push rod clockwise to decrease and counterclockwise to increase the free travel. Tighten the lock nut when adjustment is correct.

*b. Service Brake Shoe Adjustment (fig. 159).* Except where noted, the procedure for adjusting the service brake shoes is the same for all shoes.

*Note.* Do not adjust brake shoes if brake drums are hot to the touch.

- (1) Jack up the vehicle until tire clears the ground. Block one of the other wheels.
- (2) Loosen the brake shoe eccentric lock nut.
- (3) Rotate the wheel and, at the same time, turn the shoe adjusting eccentric (clockwise for front shoe, counterclockwise for

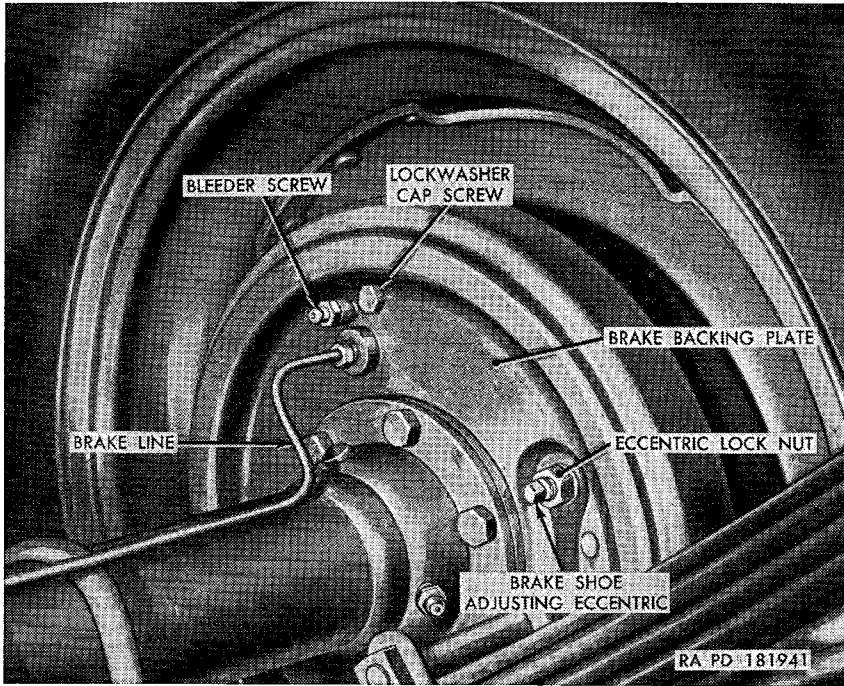

Figure 159. Rear brake backing plate installed

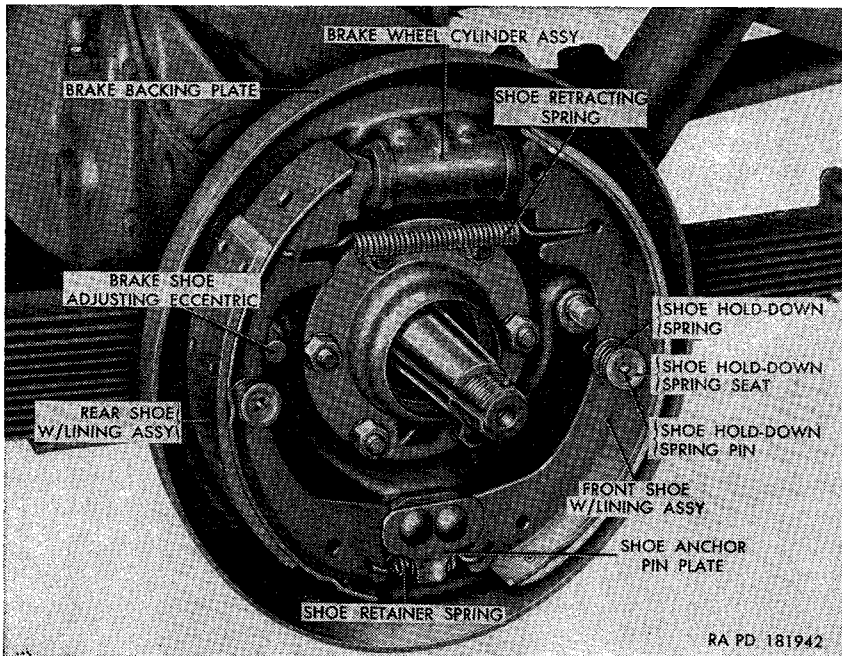

Figure 160. Rear servive brake assembly—wheel, hub and drum removed.

rear shoe) until rotating wheel begins to drag. Back off on eccentric just enough to eliminate the drag.

- (4) Hold the eccentric in the adjusted position and tighten the lock nut.
  - (5) Check the fluid level in the brake master cylinder and refill if necessary (par. 69).
  - (6) Lower vehicle to floor and operate to check brake adjustment.
- c. *Brake Shoe with Lining Assembly Removed.*

- (1) Jack up the vehicle and remove the wheel and brake drum (par. 209a).
- (2) Loosen the brake shoe eccentric lock nut (fig. 159) and turn the brake shoe adjusting eccentric (fig. 160) until the low side of the eccentric touches the brake shoe.
- (3) Unhook and remove the shoe retracting spring and the (anchor end) shoe retainer spring.
- (4) Press against the shoe holddown spring seat to compress the shoe holddown spring and turn the seat until the flat end of the shoe holddown spring pin is alined with the seat slot. Remove the spring and spring seats. Remove the opposite spring and seats in the same manner.
- (5) Remove the pins through the brake backing plate.
- (6) Spread both brake shoe with lining assemblies to disengage the upper ends of the shoes from the brake wheel cylinder assembly and the lower ends from the shoe anchor pin plate. Remove both shoes with lining assemblies.

d. *Brake Shoe with Lining Assembly Installation* (fig. 160).

*Note.* The front brake shoe with lining assembly has a longer lining than the rear brake shoe with lining assembly.

- (1) Position the front shoe with lining in the front half of the brake backing plate with the upper end of the shoe inserted into the wheel cylinder and the lower end engaged in the slot behind the shoe anchor pin plate. Install the rear shoe on the rear half of the backing plate in the same manner.
- (2) From the back of the brake backing plate, insert the brake shoe holddown pins through the holes in the plate and shoes.
- (3) Install a shoe holddown spring seat over the pin with the seat cupped side facing the shoe. Install a shoe holddown spring and a second spring seat on the pin with the second seat cupped side facing away from the shoe.
- (4) Aline the spring seat slot with the pin flat end. Force the seat over the pin and turn the seat 90° to lock it in position. Install the holddown spring and spring seats on the opposite side in the same manner.
- (5) Hook the two ends of the (anchor end) shoe retainer spring through the holes in the lower ends of the two shoes. Hook

the two ends of the shoe retracting spring into the holes in the upper ends of the two shoes.

- (6) Install the brake drum and wheel (par. 209b) but do not lower vehicle.
- (7) Adjust the brake (b(3) through (6) above).

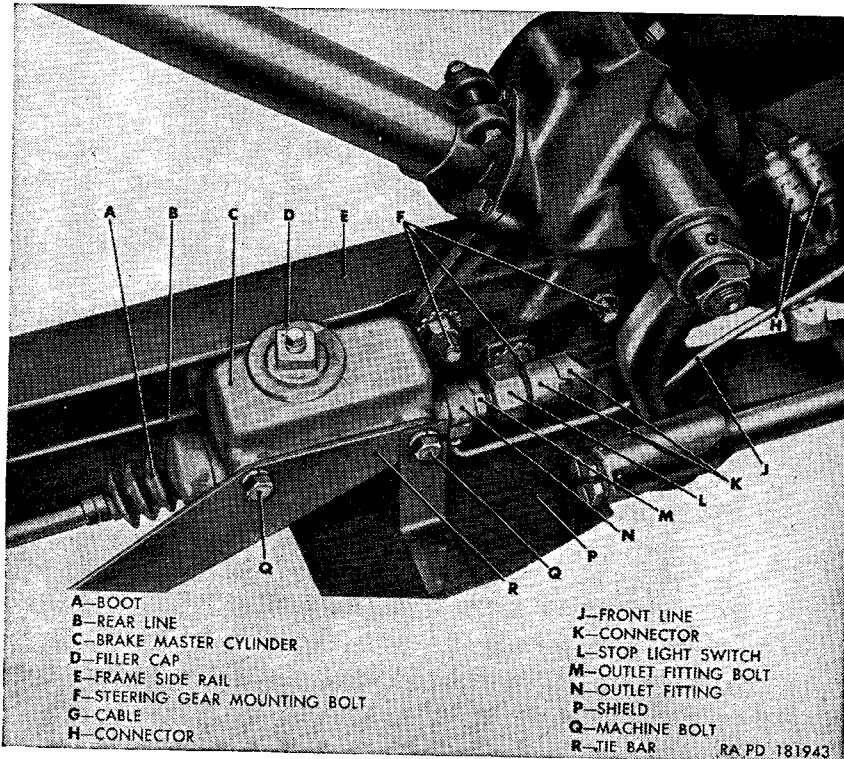

Figure 161. Brake master cylinder installed—vehicle body removed.

## 234. Brake Master Cylinder

*Note.* The key letters noted in parentheses are in figure 161, except where otherwise indicated.

### a. Filling.

- (1) Remove the four screws with internal-teeth-lockwashers securing the brake master cylinder inspection cover (fig. 157) to the upper floor pan plate. Remove the cover.
- (2) Remove the filler cap (D) and cap gasket. Fill master cylinder with brake hydraulic fluid to within **one-half inch** of top (par. 69). Install filler cap and gasket.
- (3) Make certain that the underside edge of the cover is completely coated with permagun seal 7348567 and position cover on the upper floor pan plate with the cover holes aligned with the plate (fig. 157) holes.



- (4) Secure the cover to the plate with four  $\frac{1}{4}$  x  $\frac{5}{8}$  screws with internal-teeth lockwashers.

*b. Removal.*

- (1) Loosen the steering gear mounting bolt (F). Loosen the bolt (Q) securing the front end of the master cylinder to the frame side rail. Raise the shield (P) to release the slotted ends of the shield from the loosened bolts and slide the shield toward the rear of the vehicle to remove.
- (2) Disconnect the stoplight switch cables number 75 at connectors (H and K).
- (3) Unscrew the nuts securing the master cylinder front and rear brake lines (J and B) to the outlet fitting (N) and pull the lines from the fitting. Place a suitable container under the fitting and allow the hydraulic brake fluid to drain into the container.
- (4) Remove the cotter pin and plain washer securing the master cylinder eyebolt to the stub shaft on the lower end of the brake pedal assembly (fig. 158) and slide the eyebolt from the shaft.
- (5) Work the boot (A) off the master cylinder end and remove the boot, master cylinder push rod, and eyebolt (fig. 158) as a unit.
- (6) Loosen the two machine bolts (Q) securing the tie bar (R) and master cylinder to the frame side rail (E), and pull the bolts out sufficiently to clear the side rail. Lower the master cylinder to the floor with the cylinder attached to the tie bar and with the rear end of the tie bar attached to the brake pedal shaft.
- (7) Pull the two machine bolts (Q), with lockwashers and plain washers, from the tie bar (R), and remove the master cylinder from the tie bar.
- (8) Unscrew and remove the stoplight switch (L) from the outlet fitting bolt (M). Unscrew and remove the bolt (M), outlet fitting (N), and two outlet fitting gaskets. Discard gaskets.

*c. Installation.*

- (1) Install the stoplight switch (L) in the outlet fitting bolt (M). Slip a new outlet fitting gasket, the outlet fitting (N), and another new gasket over the end of the outlet fitting bolt in the order named. Insert the bolt into the front end of the master cylinder and tighten fingertight.
- (2) With the master cylinder push rod, eyebolt (fig. 158), and boot (A) assembled as a unit, insert the end of the push rod into the rear of the master cylinder and work the boot open end over the cylinder end.



- (3) Position the master cylinder, with attached parts, next to the tie bar (R) with the tie bar holes alined with the cylinder holes. Insert two  $\frac{5}{16} \times 3$  bolts, with  $\frac{5}{16}$ -inch lockwashers and plain washers, through the tie bar and into the cylinder holes.
- (4) Raise the master cylinder into position against the frame side rail (E) and thread the bolts into the nuts welded to the frame. Tighten the rear bolt securely but leave the front bolt loose.
- (5) Position the master cylinder eyebolt, over the stub shaft on the lower end of the brake pedal assembly (fig. 158), and secure with a  $\frac{3}{16}$ -inch plain washer and  $\frac{3}{32} \times \frac{3}{4}$  cotter pin.
- (6) Turn the outlet fitting (N) to mate with the ends of the two brake lines (B and J) and secure the lines to the fitting with the nut on the end of each line. Tighten the outlet fitting bolt (M).
- (7) Connect cables number 75 at connector (H and K).
- (8) Position the shield (P) under the cylinder and slide the slots in the shield brackets over the bolt (F) securing the steering gear to the frame side rail and the front bolt (Q) securing the tie rod and master cylinder to the frame. Tighten both bolts.
- (9) Fill the master cylinder with hydraulic brake fluid (*a* above), bleed the brakes (par. 237), check the brake pedal for free play and adjust if necessary (par. 233a).

## 235. Wheel Cylinders

### *a. Removal.*

- (1) Jack up the vehicle and remove the wheel and brake drum (par. 209a).
- (2) Unhook and remove the shoe retracting spring (fig. 160) from the upper ends of the two shoes, and spread the shoes as far apart as possible.
- (3) Disconnect the brake line from the brake backing plate (fig. 159).
- (4) Remove the two lockwasher-cap screws securing the brake wheel cylinder to the backing plate and remove the cylinder (fig. 160).

### *b. Installation.*

- (1) Position the wheel cylinder (fig. 160) on the brake backing plate (fig. 159) with the cylinder holes alined with the plate holes. Secure the cylinder to the backing plate with two lockwasher cap screws.
- (2) Connect the brake line to the wheel cylinder fitting in the brake backing plate (fig. 159).

- (3) Insert the brake shoe ends into the wheel cylinder ends and install the shoe retracting spring (fig. 160).
- (4) Install the drum and wheel (par. 209*b*) and bleed the brakes (par. 237).

### 236. Flexible Lines, Solid Lines, and Connections

*Note.* The key letters noted in parentheses are in figure 162, except where otherwise indicated.

#### *a. Solid Lines.*

- (1) *Line assembly (front wheel cylinder-to-front brake flexible line) (V) (right or left side).*
  - (a) *Removal.* Unscrew the nut at each end of the line assembly (V) and remove the line from the vehicle.
  - (b) *Installation.* Position the line assembly (V) between the front wheel cylinder assembly (U) and the front brake flexible line assembly (W) and install the nut at each end of line. Bleed brakes (par. 237).
- (2) *Line assembly (front tee-to-front brake flexible line) (S) (left side).*
  - (a) *Removal.* Unscrew the nut at each end of line assembly (S) and remove the line from the vehicle.
  - (b) *Installation.* Position the line assembly (S) between the front axle tee (Z) and the front brake flexible line assembly (W) and install the nut at each end of the line. Bleed brakes (par. 237).
- (3) *Line assembly (front tee-to-front brake flexible line) (A) (right side).*
  - (a) *Removal.* Unscrew the nut at each end of the line assembly (A). Unscrew the two lockwasher bolts holding the two clips (BB). Remove the two clips (BB) from the front axle and remove the line from the vehicle.

*Note.* Do not remove the two clips unless necessary.

- (b) *Installation.* Install the two clips (BB) on the line, if they were removed. Position the line assembly (A) between the front axle tee (Z) and the front brake flexible line assembly (W) and install the nuts at each end of the line. Position the two clips (BB) over the holes in the front axle cover and fasten in place with  $\frac{5}{16} \times \frac{5}{8}$  lockwasher bolts. Install the two clips (AA) securing the line to the axle. Bleed brakes (par. 237).
- (4) *Master cylinder front line assembly.*
  - (a) *Removal.* Remove the master cylinder shield (par. 234*b*(1)). Unscrew the nut at each end of the line assembly (Q), remove the line from the clip (R) and from the vehicle.

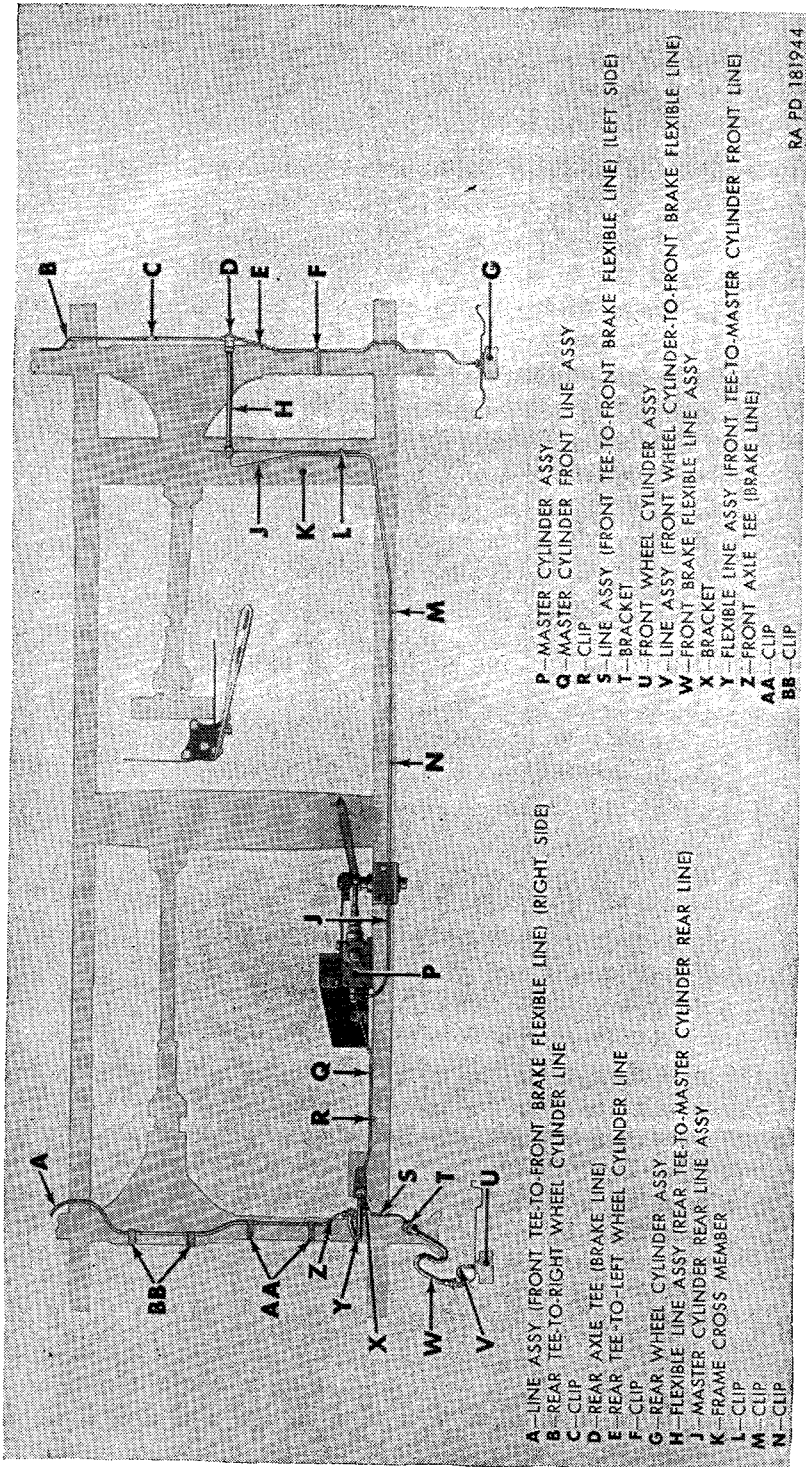

RA PD 181944

Figure 162. Service brake system arrangement.

(b) *Installation.* Position the line assembly (Q) between the master cylinder outlet fitting (N, fig. 161) and the flexible line assembly (front tee-to-master cylinder front line) (Y) and install the nuts at each end of the line. Push the line into the clip (R). Install the master cylinder shield (par. 234c(8)). Bleed brakes (par. 237).

(5) *Master cylinder rear line assembly.*

(a) *Removal.* Remove the master cylinder shield assembly (par. 234b(1)). Unscrew the nut at each end of the line assembly (J). Remove the line from the clip (L) and the two clips (M and N), and remove the line from the vehicle.

(b) *Installation.* Position the line assembly (J) between the outlet fitting (N, fig. 161) and the flexible line assembly (rear tee-to-master cylinder rear line) (H) and install the nuts at each end of the line. Push the line into the three clips (L, M, and N). Install the master cylinder shield assembly (par. 234c(8)). Bleed brakes (par. 237).

(6) *Rear tee-to-left wheel cylinder line.*

(a) *Removal.* Unscrew the nut at each end of the line (E). Remove the line from the clip (F) and from the vehicle.

(b) *Installation.* Position line (E) between the rear axle tee (D) and the rear wheel cylinder assembly (G) and install the nut at each end of the line. Place the line in clip (F). Bleed brakes (par. 237).

(7) *Rear tee-to-right wheel cylinder line.*

(a) *Removal.* Unscrew the nut at each end of line (B). Unscrew the lockwasher bolt holding clip (C) and remove line with clip from the vehicle.

*Note.* Do not remove the clip from the line unless necessary.

(b) *Installation.* Install clip (C) on line (B), if removed. Position the line between the rear axle tee (D) and the right wheel cylinder and install the nut at each end of the line. Aline the clip with the axle cover hole and install a  $\frac{5}{16} \times \frac{5}{8}$  lockwasher bolt. Bleed brakes (par. 237).

b. *Flexible Lines.*

(1) *Front brake flexible line assembly (right or left).*

(a) *Removal.* Unscrew the nut on the end of the line assembly (front wheel cylinder-to-front brake flexible line) (V) from the line assembly (W). Unscrew the nut on the outside end of the line assembly (front tee-to-front brake flexible line) (S or A) from the inside end of line assembly (V). Remove the clip from the groove at each end of the flexible line and remove the line from the vehicle.

(b) *Installation.* Position line assembly (W) between the bracket (X) on the front axle and the front brake flexible

line guard (U, fig. 134). Slide a clip into the groove at each end of the line to secure the line to the bracket and guard. Screw the nut on the line assembly (front wheel cylinder-to-front brake flexible line) (V) onto the flexible line. Screw the nut on line assembly (front tee-to-front brake flexible line) (A or S) into the flexible line. Bleed brakes (par. 237).

(2) *Flexible line assembly (front tee-to-master cylinder front line).*

(a) *Removal.* Unscrew the nut on the end of the master cylinder front line assembly (Q) from the flexible line assembly (Y). Remove the clip from the groove in the end of the flexible line. Unscrew the flexible line from the front axle tee (Z) and remove the line and copper gasket from the vehicle.

(b) *Installation.* Place the copper gasket on the male end of flexible line assembly (Y) and screw the line into the front axle tee (Z). Push the other end of the flexible line through the hole in the bracket (X) and slide the clip into the groove near the end of the line. Screw the nut on the master cylinder front line assembly (Q) into the front end of the flexible line. Bleed brakes (par. 237).

(3) *Flexible line assembly (rear tee-to-master cylinder rear line).*

(a) *Removal.* Unscrew the nut on the end of the master cylinder rear line assembly (J) from the flexible line assembly (H). Remove the clip from the groove in the end of the flexible line. Unscrew the flexible line from the rear axle tee (D) and remove the flexible line and copper gasket from the vehicle.

(b) *Installation.* Place the copper gasket on the male end of flexible line assembly (H) and screw the line into the rear axle tee (D). Push the other end of the flexible line through the hole in the frame cross member (K) and slide the clip into the groove near the end of the flexible line. Screw the nut on the end of the master cylinder rear line assembly (J) into the front end of the flexible line. Bleed brakes (par. 237).

c. *Fittings.*

(1) *Front axle tee.*

(a) *Removal.* Unscrew the nuts connecting the two solid lines from the front axle tee (Z). Unscrew the lockwasher bolt securing the tee to the axle. Unscrew the tee from the end of the flexible line, and remove the tee and copper gasket.

(b) *Installation.* Place a copper gasket on the end of the flexible line and screw the front axle tee (Z) onto the end

of the line. Position the tee on the axle hole and a  $\frac{1}{4} \times \frac{1}{8}$  lockwasher bolt. Screw the two nuts on the solid lines into the tee. Bleed the brakes (par. 237).

(2) *Rear axle tee.*

(a) *Removal.* Unscrew the nuts on the two solid lines from the rear axle tee (D). Unscrew the lockwasher bolt holding the tee to the bracket on the rear axle. Unscrew the tee from the end of the flexible line and remove the tee and copper gasket.

(b) *Installation.* Place the copper gasket on the end of the flexible line and screw the rear axle tee (D) onto the end of the line. Position the tee on the bracket on the rear axle and secure in place with a  $\frac{1}{4} \times \frac{7}{8}$  lockwasher bolt. Screw the nuts on the two solid lines into the tee. Bleed the brakes (par. 237).

(3) *Master cylinder outlet fitting.*

(a) *Removal.* Remove the master cylinder outlet fitting by following the procedure of paragraph 234b(1), (2), (3), and (8).

(b) *Installation.* Install the master cylinder outlet fitting by following the procedure of paragraph 234c(1), and (6) through (9).

## 237. Bleeding Brake System

The following procedure describes the bleeding on one service brake, but all four brakes must be bled each time.

a. Check the hydraulic fluid level in the brake master cylinder and fill if necessary (par. 234a(1) and (2)).

b. Clean the bleeder screw (fig. 159). Attach a bleeder hose to the screw and submerge the lower end of the hose in hydraulic fluid in a transparent bottle.

c. Unscrew the bleeder screw one-half turn. Depress the brake pedal by hand with a slow even pressure and allow the pedal to return to a fully released position slowly. Continue to pump the pedal slowly until no air bubbles flow from the end of the bleeder hose. Depress the pedal and hold it while tightening the bleeder screws. Release the pedal and remove the bleeder hose.

d. Recheck the fluid level in the master cylinder and fill if necessary (par. 234a).

## 238. Hand Brake

(fig. 163)

a. *Adjustment.*

(1) Place the hand brake handle (U, fig. 11) in fully released position. Check hand brake rod and operating lever to make certain that they are free and not binding.

- (2) With a feeler gage, check the clearance between the brake drum and the outer brake shoe at two points; at the top opposite the anchor pin, and at the bottom opposite the outer end of the operating lever. The clearance should be 0.010 inch at both points.

*Note.* No adjustment of the inner shoe is necessary.

If adjustment is not correct, proceed as shown in (3), (4), and (5) below.

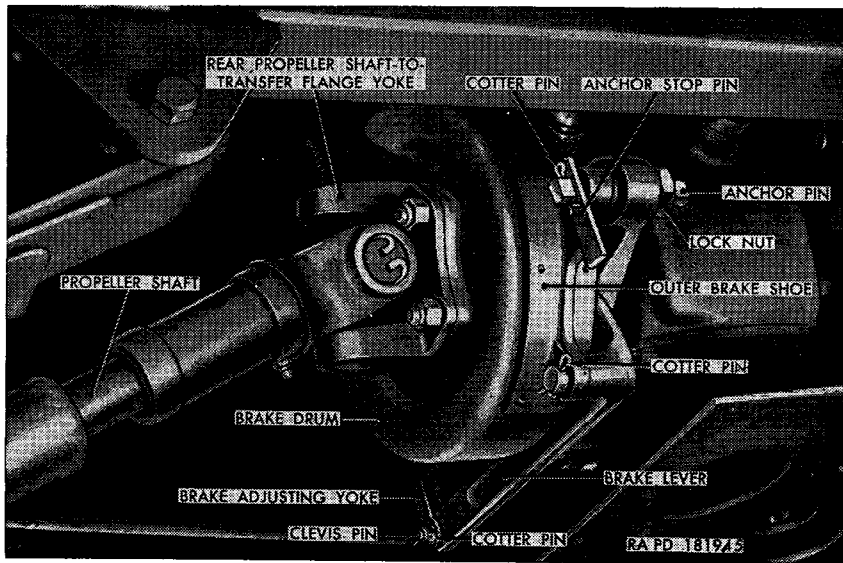

Figure 163. Hand brake assembly—installed.

- (3) Loosen the locknut on the anchor pin, and turn the anchor pin to adjust the brake shoe clearance. When adjustment is correct, tighten the locknut.
  - (4) Remove the cotter pin and clevis pin securing the operating lever to the brake rod adjusting yoke. Loosen the locknut on the brake control rod next to the adjusting yoke. Turn the yoke to adjust the clearance between the shoe and the drum (clockwise to decrease and counterclockwise to increase the clearance).
  - (5) Connect the operating lever to the adjusting yoke and install the clevis pin and cotter pin. Recheck the adjustment and, if correct, tighten the lock nut.
- b. *Brake Shoe with Lining Assembly Removal.*
- (1) Drain the transfer.

**Caution:** The companion flange hub, which is to be removed, extends into the transfer through a transfer case oil seal. The transfer oil level plug (fig. 128) is above the companion flange hub. When the flange is removed, oil in the transfer will run out over the brake shoes.

- (2) Disconnect the front end of the rear propeller shaft (par. 203a(2)). Remove the brake drum (par. 199h).
- (3) Unhook the spring extending from the brake rod adjusting yoke to the skid plate (J, fig. 58) from the yoke. Remove the cotter pin and clevis pin securing the operating lever to the adjusting yoke.
- (4) Remove the locknut and lockwasher from the anchor pin, and pull the anchor pin, with inner and outer shoes with lining assemblies attached, from the opening in the transfer rear bearing retainer.
- (5) Remove the cotter pin from the end of the anchor pin, and remove the anchor pin stop and anchor pin from the outer brake shoe.
- (6) Remove the cotter pin securing the outer brake shoe to the operating lever, and remove the shoe from the lever.
- (7) Remove the cotter pin securing the inner brake shoe to the operating lever and remove the shoe from the lever.

*c. Brake Shoe with Lining Assembly Installation.*

- (1) Position the inner brake shoe with lining assembly on the brake operating lever and secure it in place with a  $\frac{1}{8} \times \frac{3}{4}$  cotter pin.
- (2) Insert the nonthreaded end of the anchor pin through the off-center hole in the outer shoe and the anchor pin stop. Secure with a  $\frac{1}{8} \times \frac{3}{4}$  cotter pin.
- (3) Position the outer shoe, with anchor pin installed, on the operating lever so that the inner and outer shoes are directly opposite each other. Secure the outer shoe to the operating lever with a  $\frac{1}{8} \times \frac{3}{4}$  cotter pin.
- (4) Insert the threaded end of the anchor pin through the opening in the transfer rear bearing retainer, and install the operating lever, with brake shoes attached, to the retainer. Secure the parts in place by installing a  $\frac{5}{8}$ -inch lockwasher and  $\frac{5}{8}$ -inch locknut on the threaded end of the anchor pin.
- (5) Check and, if necessary, adjust the brake shoe clearance (*a* above).
- (6) Connect the end of the operating lever to the adjusting yoke and secure with the clevis pin and  $\frac{3}{16} \times \frac{1}{2}$  cotter pin.
- (7) Hook the end of the spring (K, fig. 58) extending from the skid plate to the yoke to one leg of the yoke.
- (8) Install the brake drum (par. 200b). Connect the front end of the rear propeller shaft (par. 203b(1)).
- (9) Fill the transfer (par. 69).



## Section XXIII. SPRINGS AND SHOCK ABSORBERS

### 239. Description and Data (M38A1)

*a. Description.* Both the front and rear spring assemblies (figs. 164 and 165) are of the semielliptic-type with wrapped eyes on the two top leaves. The front spring is a 12 leaf spring and the rear spring is a 13 leaf spring. One center bolt and six rebound clips secure the spring leaves of each spring assembly. Each spring assembly is suspended lengthwise from the frame by a shackle at the rear and a pivot bolt at the front. The pivot bolts ride in bushing-type eye bearings while the shackles are mounted in internally and externally threaded bushing-type shackle bearings. U-Bolts secure each spring assembly to its respective axle. Four hydraulic, double-action shock absorbers are used to control the spring action when flexing. The shock absorbers, mounted to the frame and U-bolt plates, are nonadjustable and nonrefillable.

*b. Data.*

Front spring assemblies:

Length (center of spring eyes, arched)..... 38 $\frac{3}{8}$  in.  
Make..... Mather Spring Co  
Number of leaves..... 12  
Number of rebound clips..... 6

Rear spring assemblies:

Length (center of spring eyes, arched)..... 44 $\frac{3}{4}$  in.  
Make..... Mather Spring Co  
Number of leaves..... 13  
Number of rebound clips..... 6

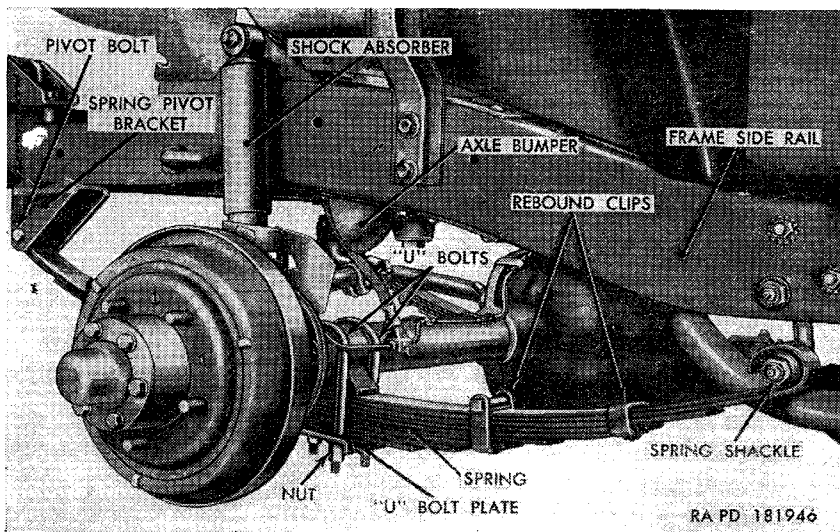

Figure 164. Front spring assembly and shock absorber—installed—wheel removed.

Extended length :	
Front.....	16¾ in.
Rear.....	19½ in.
Make.....	Monroe
Type.....	hydraulic, double-action

## 240. Description and Data (M170)

*a. Description.* Both the front and rear spring assemblies are of the semielliptic type with wrapped eyes on the two top leaves. The front spring is a 10-leaf spring and the rear spring is an 11-leaf spring. One center bolt and four rebound clips secure the spring leaves of each spring assembly. Each spring assembly is suspended lengthwise from the frame by a shackle at the rear and a pivot bolt at the front. The pivot bolts ride in bushing-type eye bearings while the shackles are mounted in internally and externally threaded bushing-type shackle bearings. U bolts secure each spring assembly to its respective axle. Four hydraulic, double-action shock absorbers are used to control the spring action when flexing. The shock absorbers, mounted to the frame and U-bolt plates, are nonadjustable and nonrefillable.

### *b. Data.*

#### Front spring assemblies :

Length (center of spring eyes, arched).....	39½ in.
Make.....	Mather Spring Co
Number of leaves.....	10
Number of rebound clips.....	4

#### Rear spring assemblies :

Length (center of spring eyes, arched).....	46
Make.....	Mather Spring Co
Number of leaves.....	11
Number of rebound clips.....	4

#### Shock absorber assemblies :

##### Collapsed length :

Front.....	11.44 in.
Rear.....	11.94 in.

##### Extended length :

Front.....	18.44 in.
Rear.....	19.44 in.
Make.....	Monroe
Type.....	hydraulic, double-action

## 241. Organizational Maintenance

Inspect the front spring, rear spring, and shock absorber assemblies periodically for wear or breakage. Lubricate the spring shackles in accordance with the lubrication chart (fig. 29). The pivot bolts require no lubrication. The shock absorbers require no attention except to replace the inoperative or damaged units and worn or deteriorated mounting pin bushings. Replace spring, spring shackles, shackle bearings, and pivot bolts if damaged or worn.

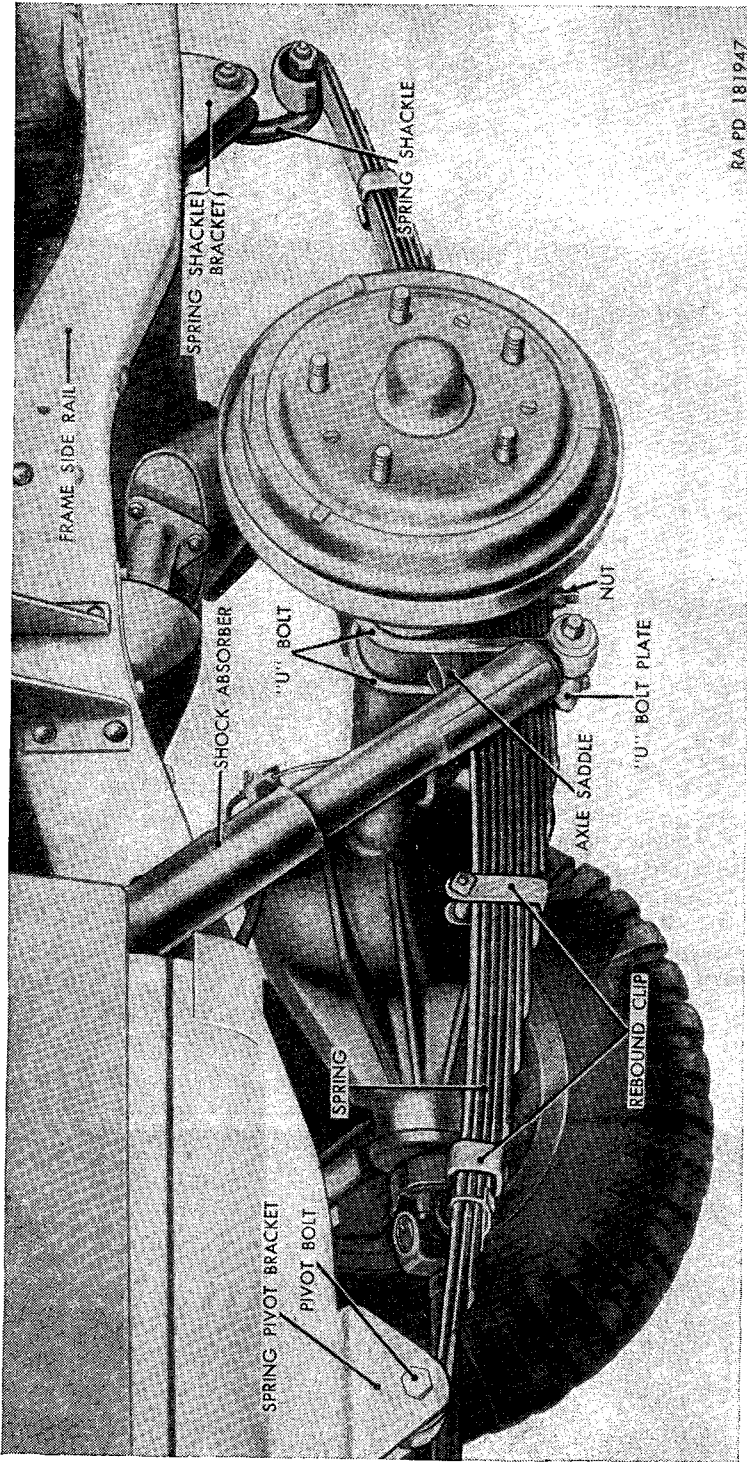

RA PD 181947

Figure 165. Rear spring assembly and shock absorber—installed—wheel removed.

## 242. Spring Shackles (M38A1)

### a. Removal.

- (1) Remove the lock nut and flat washer securing the lower end of the shock absorber (fig. 165) to the U-bolt plate. Pull the lower end of shock absorber and the two mounting pin bushings off the shaft of the U-bolt plate. Remove the two bushings out of the end of the shock absorber.
- (2) Raise the vehicle frame until both tires clear the ground. Using safety stands or suitable blocking, support the vehicle

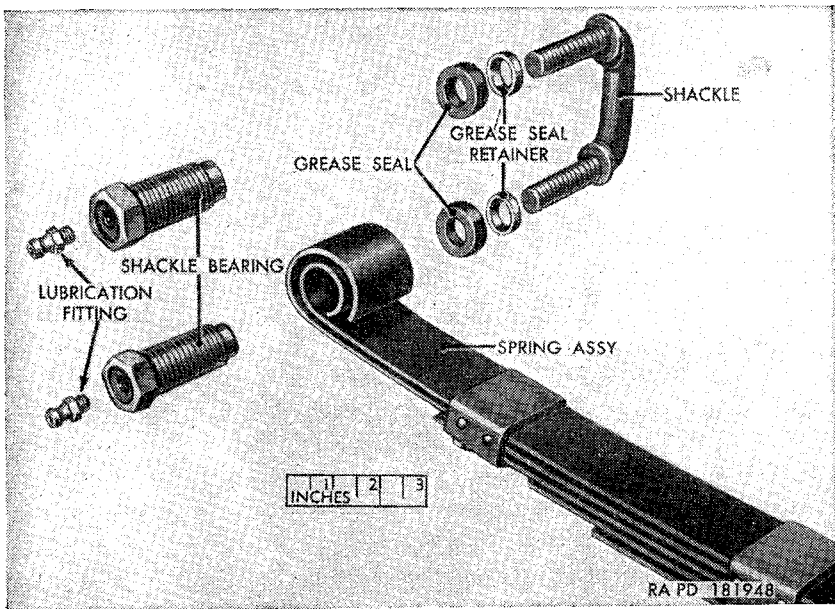

Figure 166. Spring shackle and spring shackle end of spring (M38A1)—exploded view.

- weight. Place a jack under the axle housing and adjust the jack height, as necessary, to take the tension off the spring.
- (3) Unscrew and remove the bushing-type shackle bearings (fig. 166).

*Note.* The lower bearing on the left front and right rear springs have left-hand threads.

Unscrew the lubrication fitting from the end of each bearing.

- (4) Pull the spring shackle, with grease seals and grease seal retainer, from the eye of the spring assembly and frame side rail (for front spring) or spring bracket (for rear spring).
- (5) Slip the grease seals and grease seal retainers off the shackle.

### *b. Installation.*

*Note.* The left-hand thread on the bushing-type shackle bearing is identified by a groove in its hexagon head. The left-hand thread on the shackle is identified by a boss on the shoulder of the shackle at the base of the thread. See Note in *a* (3) above for correct location.

- (1) Slip a grease seal retainer and a grease seal over each of the shackle threads, with the cupped side of the retainers toward the shackle ends.
- (2) Insert the shackle ends into the inner side of the spring assembly and the inner side of the frame side rail (for front spring) (fig. 164) or spring shackle bracket (for rear spring) (fig. 165) and push the shackle in until the ends are almost protruding from the spring eye and frame side rail or spring bracket.
- (3) Insert the bushing-type shackle bearings (fig. 166) and start the threads, making certain that the threads start on the shackle before they start on the inner threads of the spring eye, frame side rail, or spring shackle bracket. Take up on both bearings until tight, then back off the lower bearing about one thirty-second inch (one-third of a turn). Screw a lubrication fitting in the end of each bearing. Lubricate shackle as directed on the lubrication chart (fig. 29).
- (4) Install one mounting pin bushing, with the taper facing out, on the **U**-bolt plate shaft. Install the lower end of the shock absorber assembly (fig. 165) on the **U**-bolt plate shaft. Install another mounting pin bushing, with the taper facing in, on the **U**-bolt plate shaft. Seat the two bushings in the hole in the shock absorber end. Secure the shock absorber to the **U**-bolt plate with one ½-inch ID flat washer and 7/16-inch locknut. Tighten nut until a slight bulge is noted in the bushings.
- (5) Remove the safety stands or blocking, and lower vehicle to ground.

## **243. Spring Shackles (M170)**

### *a. Removal.*

- (1) Remove the locknut and the flat washer securing the lower end of the shock absorber (fig. 165) to the **U**-bolt plate. Pull the lower end of the shock absorber and the two mounting pin bushings off the shaft of the **U**-bolt plate. Remove the two bushings out of the eye of the shock absorber.
- (2) Remove the cotter pin and unscrew the nut from the upper end of the stabilizer bar link from the **U**-bolt plate-to-stabilizer and remove the cup washer and the grommet.
- (3) Raise the vehicle frame until both tires clear the ground. Using safety stands or suitable blocking, support the vehicle

- weight. Place a jack under the axle housing and adjust the jack height, as necessary, to take the tension off the spring.
- (4) Remove the nuts securing the side plate to the spring shackle and remove the plate and the grease seals. Unscrew and remove the bushing-type shackle bearings (fig. 167).
  - (5) Pull the spring shackle, with grease seals and grease seal retainers, from the eye of the spring assembly and frame side rail (for front spring) or spring bracket (for rear spring).
  - (6) Slip the grease seals and the grease seal retainers off the shackle. Remove the lubrication fittings from the shackle.

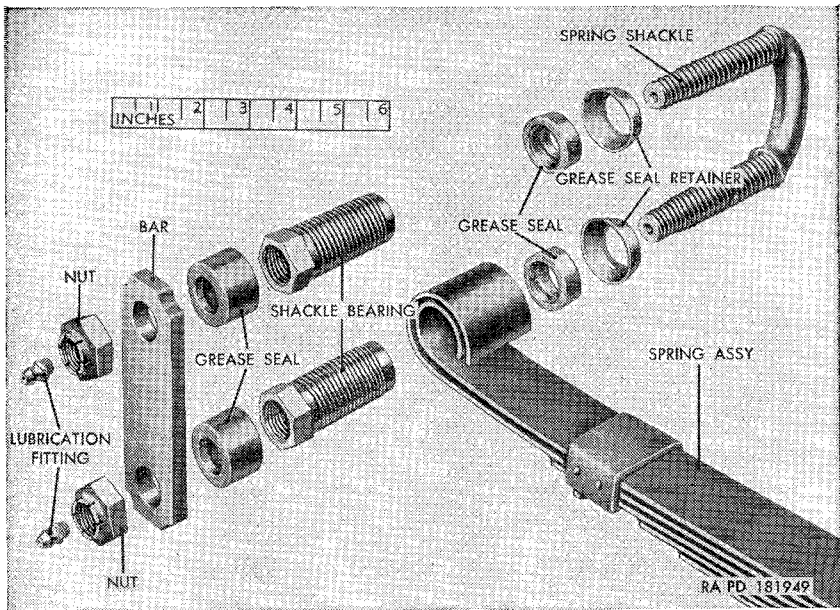

Figure 167. Spring shackle end of spring and spring shackle (M170)—exploded view.

*b. Installation.*

- (1) Slip a grease seal retainer and a grease seal in the order named over each of the shackle threaded parts. Start the small inside diameter of the retainers on the shackle.
- (2) Insert the shackle ends into the inner side of the spring assembly and the inner side of the frame side rail (for front spring (fig. 164)) or the spring bracket (for the rear spring (fig. 165)) and push the shackle in until the ends are almost protruding from the spring eye and frame side rail or spring bracket.

- (3) Insert the bushing-type shackle bearings into the spring eye and frame side rail or bracket and start the bearings onto the shackle before the bearings start threading into the eye or frame side rail or spring bracket. Take up on both bearings equally until they are tight. Back off the lower bearing about one thirty-second inch (one-third of a turn).
- (4) Place a grease seal over the hex head of each bearing. Slide the side plate over the shackle ends and secure with two nuts. Install the lubrication fittings in the shackle end.
- (5) Raise the axle assembly with the jack until the upper end of the link between the U-bolt plate and the stabilizer bar enters the hole in the bar end. Install a grommet and a cup washer over the link end. Secure the link grommet and washer to the bar with a nut and cotter pin.
- (6) Install one mounting pin bushing, with the taper facing out, on the U-bolt plate shaft. Install the lower end of the shock absorber assembly (fig. 165) on the shaft. Install another mounting pin bushing, with the taper facing in, on the shaft. Seat the two bushings in the eye on the shock absorber end. Secure the shock absorber to the shaft with one 1/2-inch ID flat washer and a 7/16-inch locknut. Tighten until a slight bulge is noted in the bushings.
- (7) Remove the safety stands or blocking, and lower the vehicle to the ground.

## 244. Pivot Bolts

### *a. Removal.*

- (1) Remove the locknut and flat washer securing the lower end of the shock absorber (fig. 165) to the U-bolt plate. Pull the lower end of shock absorber and the two mounting pin bushings off the U-bolt plate shaft. Remove the two bushings out of the hole in the shock absorber end.
- (2) Raise the vehicle frame until both tires clear the ground. Using safety stands or suitable blocking, support the vehicle weight. Place a jack under the axle housing and adjust the jack height, as necessary, to take the tension off the spring.
- (3) Unscrew the safety nut (fig. 168) from the pivot bolt. Withdraw the bolt from the spring pivot bracket and the bushing-type eye bearing in the spring eye. It may be necessary to drive the bolt out of the eye bearing with a suitable drift pin.

### *b. Installation.*

- (1) Adjust the jack height beneath the axle housing, as necessary, to aline the hole in the bushing-type eye bearing in the spring eye with the holes in the spring pivot bracket (figs. 164 and 165). Insert the 7/16 x 3 pivot bolt (fig. 168) through

bracket outer flange, through eye bearing and through the bracket inner flange. Secure the bolt with a  $\frac{7}{16}$ -inch safety nut. Tighten nut to a torque of 27 to 30 pound-feet.

- (2) Install one mounting pin bushing, with the taper facing out, on the **U**-bolt plate shaft. Install the lower end of the shock absorber assembly on the **U**-bolt plate shaft. Install another mounting pin bushing, with the taper facing in, on the **U**-bolt plate shaft. Seat the two bushings in the hole in the shock absorber end. Secure the shock absorber (fig. 165) to the

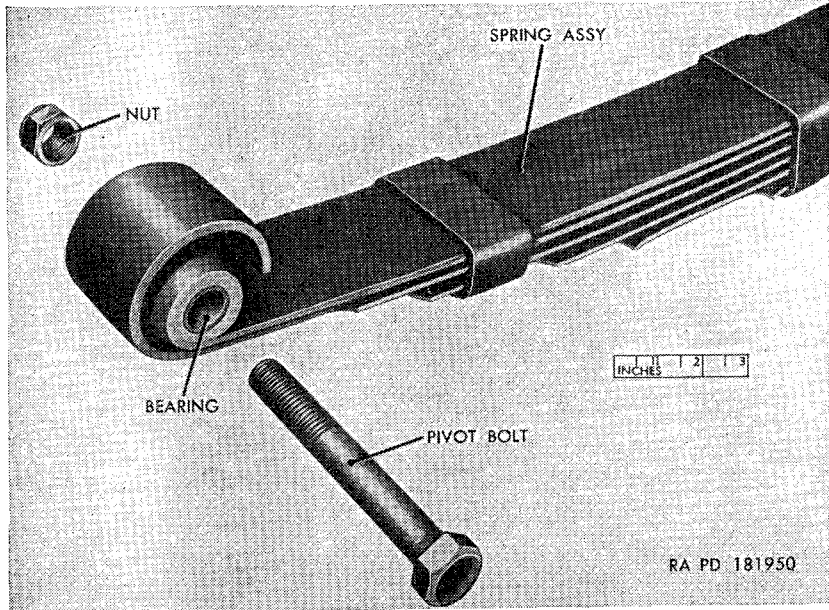

Figure 168. Pivot bolt end of spring—exploded view pivot bolt and nut removed.

**U**-bolt plate with one  $\frac{1}{2}$ -inch ID flat washer and  $\frac{7}{16}$ -inch locknut. Tighten nut until a slight bulge is noted in the bushing.

- (3) Remove the safety stand or blocking, and lower vehicle to the ground.

## 245. Spring Assemblies (M38A1)

### a. Removal.

- (1) Remove the spring shackle (par. 242a).
- (2) Remove the pivot bolt (par. 244a(3)).
- (3) While supporting the spring assembly, remove the four **U**-bolt nuts (figs. 164 and 165) and lockwashers securing the two **U**-bolts to the **U**-bolt plate and remove the plate from beneath the spring. Lift the **U**-bolts off the axle housing. Remove the spring assembly from beneath the vehicle.



### *b. Installation.*

- (1) Place the spring assembly in approximate position under vehicle, raise pivot end of spring and install pivot bolt (par. 244*b*(1)).
- (2) Raise spring shackle end of spring into position and install spring shackle (pars. 242*b*(1), (2), and (3)).
- (3) Using the jack beneath the axle housing, slowly lower axle onto spring, making certain that the spring center bolt enters the spring saddle recess on the axle housing underside.
- (4) Install the **U**-bolts over the axle housing.

*Note.* On the front right spring assembly, the wide **U**-bolt is installed over the differential housing.

(Align the holes in the **U**-bolts and place the plate, with its shaft facing wheel, against the bottom of the spring.) Secure the **U**-bolts to the **U**-bolt plate with four  $\frac{7}{16}$ -inch lockwashers and **U**-bolt nuts. Tighten nuts to torque of 50–55 pound-feet.

- (5) Install one mounting pin bushing, with the taper facing out, on the **U**-bolt plate shaft. Install the lower end of the shock absorber assembly on the **U**-bolt plate shaft. Install another mounting pin bushing, with the taper facing in, on the **U**-bolt plate shaft. Seat the two bushings in the hole in the shock absorber end. Secure the shock absorber (fig. 165) to the **U**-bolt plate with one  $\frac{1}{2}$ -inch ID flat washer and  $\frac{7}{16}$ -inch locknut. Tighten nut until a slight bulge is noted in the bushings.
- (6) Remove the safety stands or blocking, and lower the vehicle to the ground.

## **246. Spring Assemblies (M170)**

### *a. Removal.*

- (1) Remove the spring shackle (par. 243*a*).
- (2) Remove the pivot bolt (par. 244*a*(3)).
- (3) While supporting the spring assembly, remove the four **U**-bolt nuts and lockwashers securing the two **U**-bolts to the **U**-bolt plate with the **U**-bolt plate-to-stabilizer bar link and remove the plate from the bolts and the bottom of the spring. Lift the **U**-bolts off the axle housing. Remove the spring assembly from the vehicle.

### *b. Installation.*

- (1) Place the spring assembly in the approximate position under the vehicle. Raise the pivot end of the spring and install the pivot bolt (par. 224*b*(1)).

- (2) Raise the shackle end of the spring into position and install the shackle (par. 243b(1), (2), (3), and (4)).
- (3) Follow procedure in paragraph 245b(3) and (4).
- (4) Follow procedure in paragraph 243b(5), (6), and (7).

## **247. Shock Absorber Assemblies**

(figs. 164 and 165)

### *a. Removal.*

- (1) Remove the locknut and flat washer securing the upper end of the shock absorber assembly (fig. 164) to the shock absorber mounting bracket. Remove the locknut and flat washer securing the lower end of the shock absorber (fig. 165) to the U-bolt plate.
- (2) Pull the shock absorber and mounting pin bushings off the bracket and plate shafts.
- (3) Pull the two mounting pin bushings out of the hole in each shock absorber end.

### *b. Installation.*

- (1) Install a mounting pin bushing, with the taper facing out, on the shock absorber mounting bracket shaft and on the U-bolt plate shaft.
- (2) Position the shock absorber assembly, small end down, on the shaft bushings. Install another bushing, with the taper facing in, on the bracket shaft and on the plate shaft. Seat the two bushings at each shock absorber end in the hole at the shock absorber end.
- (3) Secure the shock absorbers to the bracket and plate with two ½-inch ID flat washers and 7/16-inch locknuts. Tighten each nut until a slight bulge is noted in the bushings.

## **Section XXIV. WHEELS AND TIRES**

### **248. Description and Data**

*a. Description.* Each vehicle is equipped with four standard drop-center, interchangeable operating wheels and one spare. Each operating wheel is mounted on the wheel hub by five studs, pressed into the hub. A taper on the inside of each hub nut positions the wheel to allow clearance between wheel and hub for ease of removal. Hub studs and nuts on the left side of the vehicle have left-hand threads and are marked with the letter L. Hub studs on the right side of vehicle have right-hand threads and are not marked. The military, nondirectional mud- and snow-type tires are designed for either high or low pressure operation.

*b. Data.*

**Wheels :**

Ordnance number..... 7387807  
Type..... std drop-center  
Rim size..... 4.50 x 16.00 in.  
Stud circle diameter..... 5.496 x 5.504 in.

**Tires :**

Type..... Military nondirectional  
Size..... 7.00 x 16.00 in.

**Operating pressures :**

Highway..... 28 psi  
Cross country..... 22 psi  
Mud, sand, or snow..... 15 psi

**249. Organizational Maintenance**

*a. Wheels.* Inspect all wheels at regular intervals for bent rims, worn or elongated mounting stud holes, and signs of rust. Pay particular attention to edges of rims and mounting stud holes. Inspect hub studs and nuts for worn or stripped threads. Replace any defective wheel or hub nut immediately.

*b. Tires.* Inspect all tires and check pressures daily.

- (1) Replace any tire with noticeable cut on tread or side wall. Return old tire to ordnance maintenance unit for repair. If uneven wear is indicated, check toe-in adjustment (par. 224). If incorrect toe-in is not the cause, report to ordnance maintenance personnel.
- (2) Check pressures when tires are cold. Dismount any tire showing unusual pressure loss and examine tire tube for cause. Repair tire tube or replace tube or tire if necessary.
- (3) Inflate all tires to equal pressures, as unequal pressures will affect steering and braking adversely. Inflate tires to pressures designated in paragraph 248*b*. Under inflated tires are easily damaged. Install all valve caps to prevent air loss.

*c. Tire Rotation.* To maintain equal wear, rotate tires in accordance with the tire rotation plan shown in figure 169 at intervals of approximately 2,000 miles, if the tactical situation permits.

*d. Tire Replacement.* Make certain that a replacement tire is of the same design, size, and tread as the tires on the vehicle. Tires of different design or tread sometimes have different rolling diameters, causing excessive scuffing in use.

**250. Wheels**

*a. Removal.* Loosen five hub stud nuts (fig. 170) (left side vehicle, clockwise; right side, counterclockwise). Jack up vehicle (fig. 171) until tire clears the ground. Block other wheels to prevent vehicle from rolling. Remove five hub nuts and remove wheel.

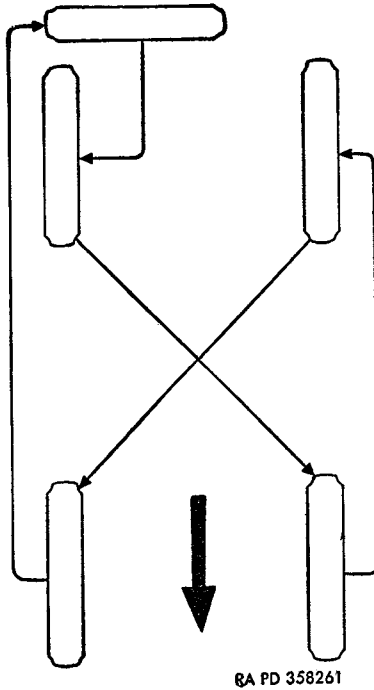

Figure 169. Tire rotation plan.

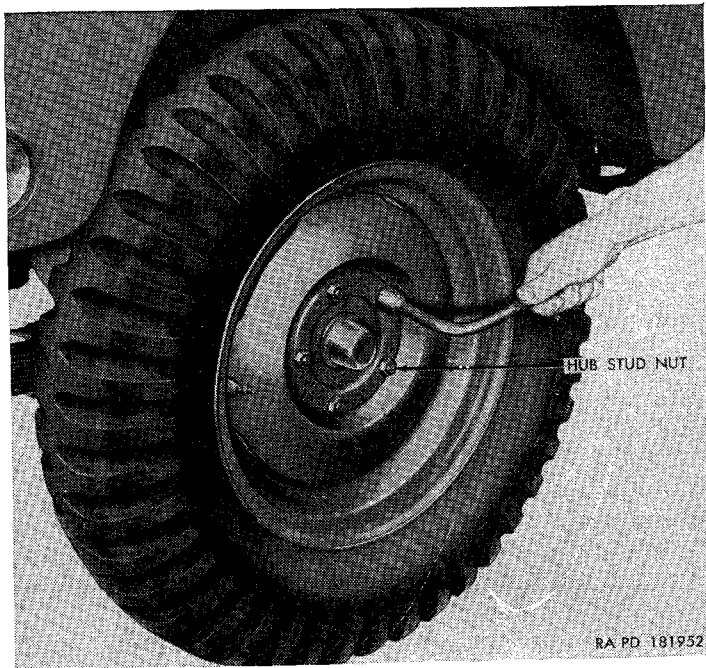

Figure 170. Loosening wheel hub stud nuts.

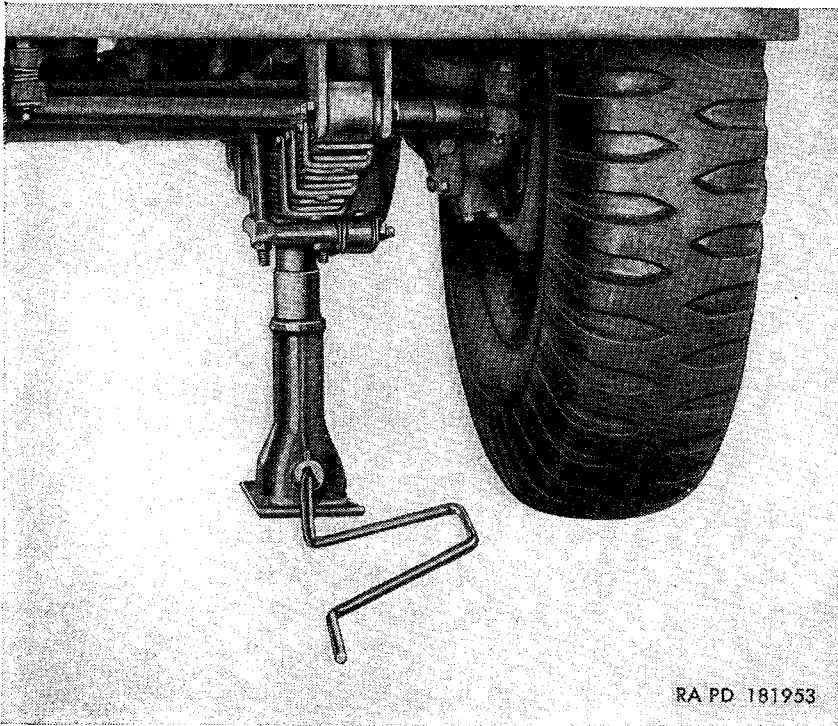

Figure 171. Front wheel of vehicle—jacked up.

*b. Installation.* Clean adjacent surfaces of wheel and hub. Make certain that hub studs and nuts are free of grease or oil. Place wheel on studs and start five  $\frac{1}{2}$ -inch nuts on stud threads. Tighten nuts alternately and evenly. Lower vehicle to the ground and remove blocking. Tighten hub nuts again.

## 251. Spare Wheel and Tire

### *a. Removal (M38A1).*

- (1) Remove the three nuts securing the spare wheel and tire to the spare wheel mounting bracket studs (fig. 172).
- (2) Remove the spare wheel and tire.

### *b. Installation (M38A1).*

- (1) Position the spare wheel on the spare wheel mounting bracket studs on the right rear of the vehicle.
- (2) Install three  $\frac{1}{2}$ -inch nuts on the mounting bracket studs.

### *c. Removal (M170).*

- (1) Using the hub stud wrench supplied with the vehicle, loosen the bolt securing the plate (fig. 173) and spare wheel to the mounting bracket.
- (2) Unscrew the bolt with the fingers and remove the bolt and plate.
- (3) Remove the spare wheel and tire from the well.

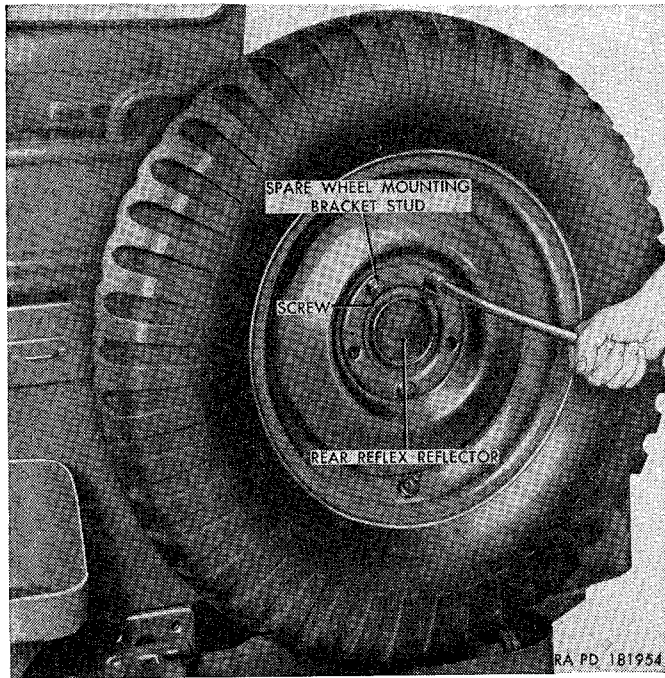

Figure 172. Spare wheel and tire (M38A1).

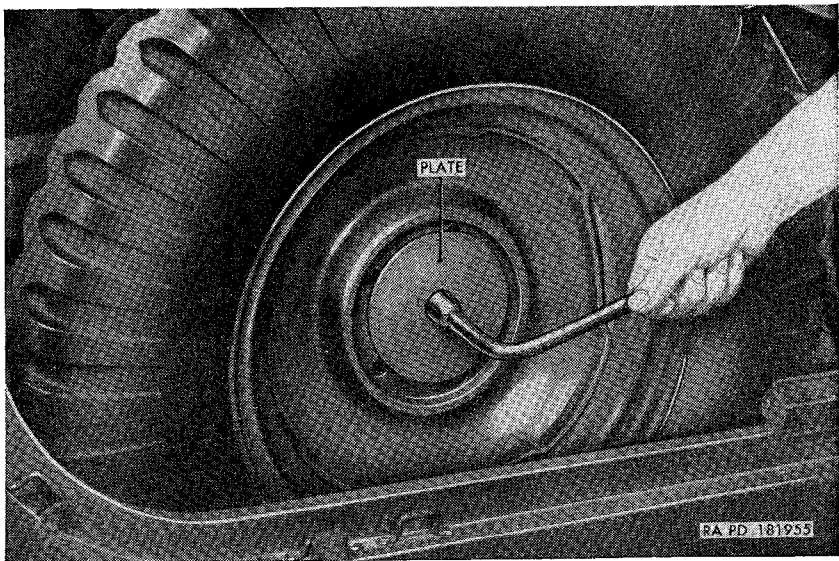

Figure 173. Spare wheel and tire (M170).

*d. Installation (M170).*

- (1) Place the spare wheel and tire in the well to the right of the passenger's seat.
- (2) Position the holding plate on the center of the spare wheel. Start a  $\frac{1}{2}$  x 4 bolt into the mounting bracket threads and finger tighten.
- (3) Using the hub stud wrench supplied with the vehicle, tighten the bolt.

## **252. Tires and Tubes**

For instructions on removal, repair, and installation of tires and tubes, refer to TM 31-200.

## **Section XXV. BODY AND FRAME (M38A1)**

### **253. Description and Data**

*a. Description.*

- (1) *Body.* The body (figs. 1 and 2) is an all steel, four-passenger open-type of seamed and welded construction. Mounting shims and cushions insulate the body from the frame. The body is equipped with a driver's seat, passenger seat and rear seat, tool compartment, battery stowage box, bows for installation of the top cover with rear curtain, spare wheel support bracket, and spare fuel can bracket. The passenger's seat is hinged to permit access to the tool compartment. The folding-type rear seat provides seating accommodations when in the lowered position, and extra carrying space on the floor when in the raised position. Weather protection is provided by the top cover which may be removed and stored in clement weather. A two-piece, folding-type windshield, with two windshield wiper vacuum motors attached to the windshield frame, is secured to the body cowl. An outside rear view mirror is mounted on the body cowl to the left of the driver. The removable hood and front fenders are formed sheet metal. Two front floor pan covers provide access to the rear of the engine compartment, transmission, transfer, master cylinder, and steering gear. Reflex reflectors are bolted to the rear and sides of the body.
- (2) *Frame.* The frame is constructed of two heavy channel steel side rails and five cross members. All cross members, except the engine rear support cross member, are welded to the side rails. The support cross member is bolted to the rails. Two rear reinforcements are welded to the side rails and the rear cross member. A towing pintle, mounted on the rear cross member, provides for towing a trailer. Two front lifting

shackles and two rear lifting shackles are provided. A bumper bar is bolted to the front ends of the side rails. Two bumperettes are bolted to the rear cross member. Brackets and supports provide mounts for the engine, body, shock absorbers, and springs.

*b. Data.*

**Body :**

Construction ----- welded  
 Driver's position ----- left  
 Length (to inside of dash panel) ----- 80.13 in.  
 Type ----- all steel, open  
 Width (edge of reflex reflectors) ----- 60.38 in.  
 Windshield type ----- two-piece, folding

**Frame :**

Length ----- 128.44 in.  
 Material ----- steel, SAE 950  
 Number of cross members ----- 5  
 Weight (aprx) ----- 140 lb  
 Width ----- 29.25 in.

**254. Windshield Assembly**

*a. Lowering.* Unclamp the windshield lock (fig. 174) at each side of the windshield from the lock catch on the instrument panel. Carefully lower windshield forward until the two windshield-to-hood

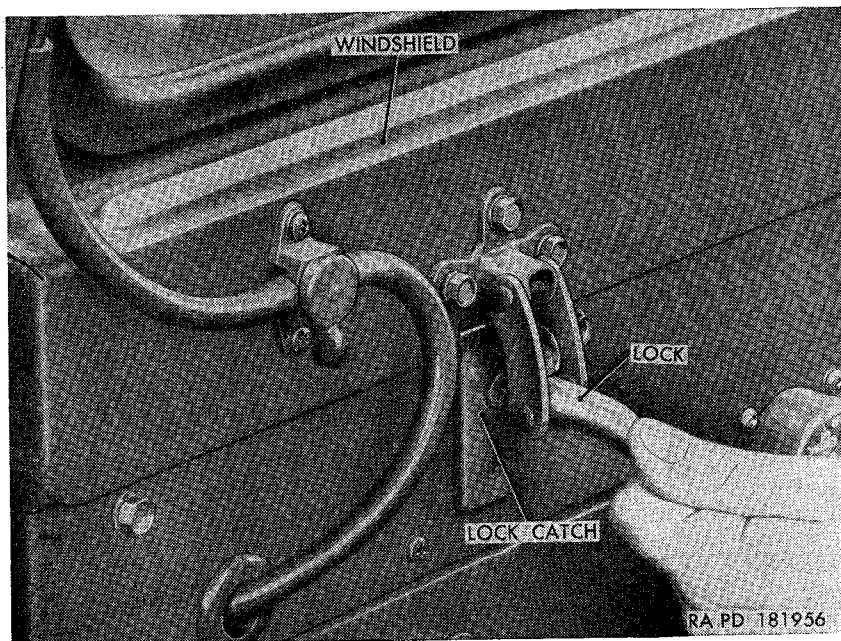

*Figure 174. Unclamping windshield lock assembly.*



bumpers rest on the hood. Secure windshield in lowered position by inserting the end of the windshield holddown strap with buckle assembly (secured on inner side of windshield frame) through the footman loop (fig. 175) on the hood and securing the strap in its buckle.

*b. Raising.* Unbuckle the windshield holddown strap (fig. 175) and withdraw strap from the footman loop on hood. Raise windshield to its upright position. Secure the windshield in raised position by clamping the windshield lock, at each side of the windshield, on the lock catch (fig. 174) on the instrument panel.

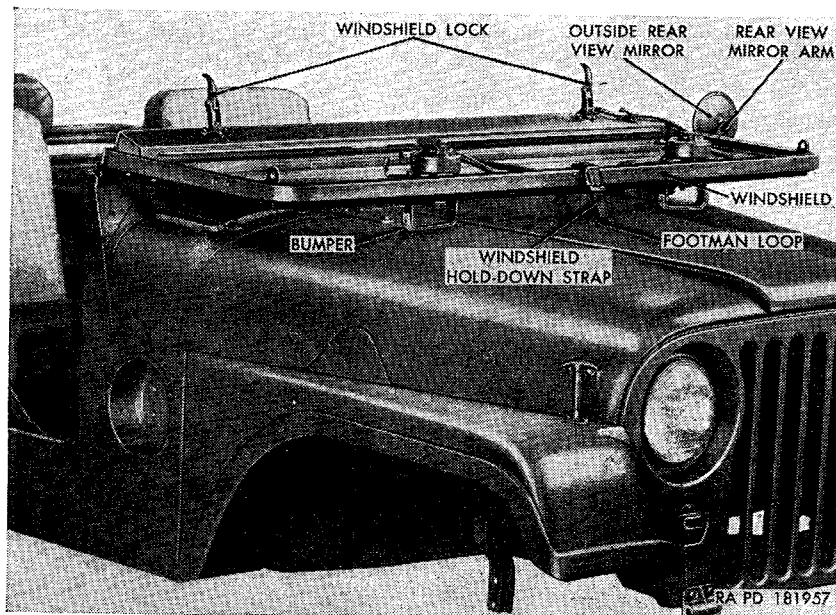

Figure 175. Windshield assembly—lowered position.

## 255. Hood Assembly

*a. Raising.* Unhook the hood catch (fig. 176) from the catch bracket on each side of the hood assembly. Raise the hood up and rearward until it rests against the top of the windshield assembly. Lock the hood in raised position by engaging the catch U-bolt on the hood in the lock catch at top of the windshield (fig. 177).

*b. Lowering.* Disengage the catch U-bolt from the lock catch (fig. 177) at the top of the windshield. Lower hood until its front rests on the radiator guard. Secure hood in closed position by hooking a hood catch (fig. 176) onto a catch bracket on each side of the hood.

*c. Removal.* Unhook the hood catch from the catch bracket on each side of the hood (fig. 176). Raise hood until it is almost up against windshield, line up the flat sides on the hinge pins with the openings in the hood hinge assemblies and lift the hood to disengage

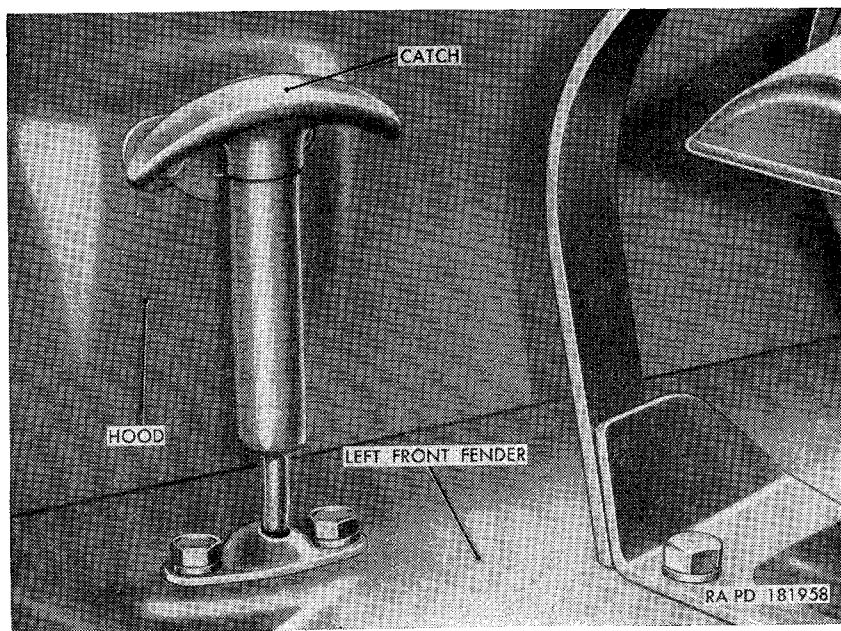

Figure 176. Hood catch engaged.

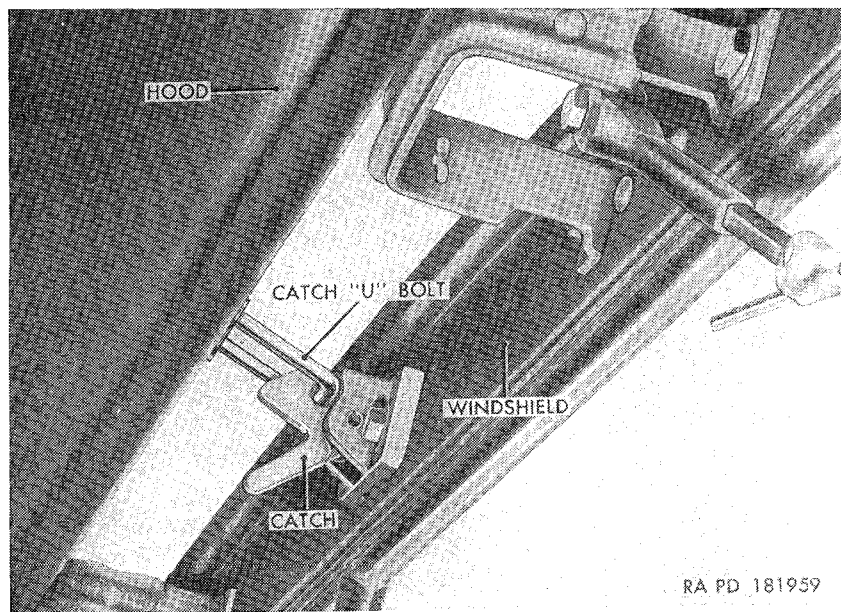

Figure 177. Hood lock catch engaged at top of windshield.

the hinge pins from the hood hinges. Remove the hood from the vehicle.

*d. Installation.* Position the hood in an upright position over the body cowl. Aline the flat sides of the hinge pins with the openings in the hood hinges and slip the pins into the hinges. Lower hood to the closed position. Secure hood in closed position by hooking a hood catch (fig. 176) onto a catch bracket on each side of the hood.

## 256. Front Fenders

*Note.* If both front fenders are to be removed, start by detaching the radiator guard with deflector assembly (par. 257a(3)). If only one fender is to be removed, proceed as outlined in par. *a* or *b* below.

### *a. Left Front Fender Removal.*

- (1) Raise hood and lock in raised position (par. 255a).
- (2) Remove blackout driving light assembly (par. 164b).
- (3) Remove horn assembly (par. 184d).
- (4) Free the electrical cables from the four fender clips. Free the fuel line from the fender clip.
- (5) Remove the four lockwasher screws (fig. 178) securing the rear of the left front fender to the front of the body cowl.

*Note.* The three top screws are accessible from inside of engine compartment. The lowest screw is accessible from beneath body.

- (6) Remove the two top lockwasher screws (fig. 179) securing the front of the fender to the radiator guard. Loosen the lockwasher screw at the bottom of the radiator guard to permit disengagement of the fender mounting slot.
- (7) Remove the two lockwasher screws and flat washers securing the fender brace to the frame side rail (fig. 180).
- (8) Pull fender to the left and remove from vehicle.
- (9) Remove the upper and lower front fender-to-cowl side panel antisqueak (webbing) from the body cowl.
- (10) Remove the clips used to secure the electrical cables and fuel lines to the fender.

### *b. Right Front Fender Removal.*

- (1) Raise hood and lock in raised position (par. 255a).
- (2) Remove the nut and lockwasher screw and lift the clip (fig. 181) on the battery ground cable from the fender splash apron.
- (3) Disconnect rear of fender from body cowl (*a*(5) above).
- (4) Disconnect front of fender from radiator guard (*a*(6) above).
- (5) Disconnect the fender brace (*a*(7) above).
- (6) Pull fender to the right and remove from vehicle.
- (7) Remove antisqueak (webbing) (*a*(9) above).

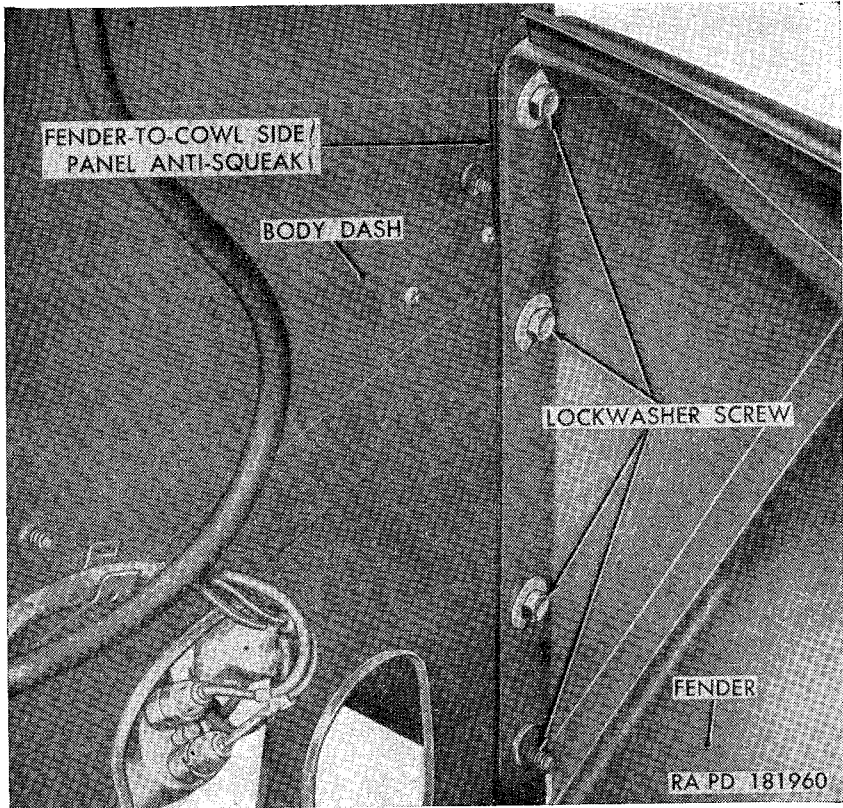

Figure 178. Rear of left front fender secured to body dash.

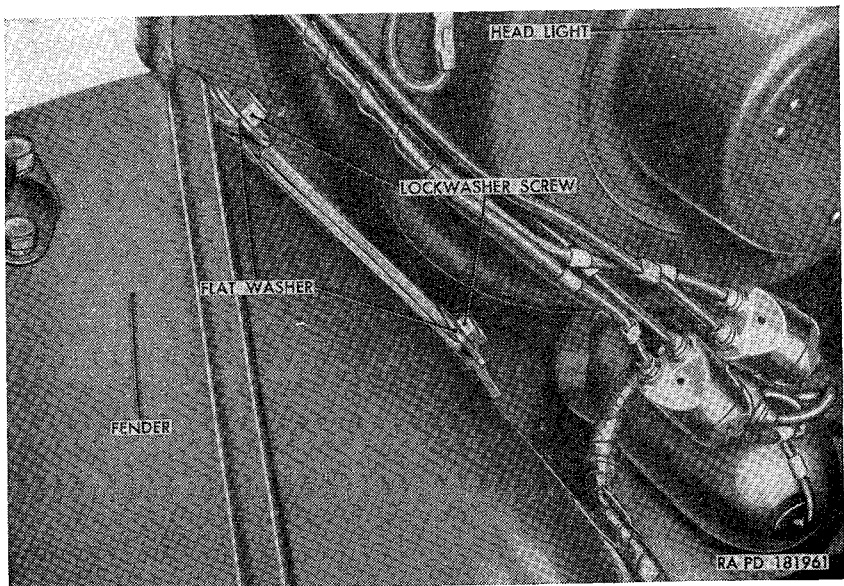

Figure 179. Front of left front fender secured to radiator guard.

*c. Left Front Fender Installation.*

- (1) Install the clips securing the electrical cables and fuel line on the fender.
- (2) Cement new lower and upper front fender-to-cowl side panel antisqueak (webbing) in place on the body cowl.
- (3) Position fender on the body, alining fender mounting holes with body cowl, radiator guard, and frame mounting holes.
- (4) Secure the fender brace (fig. 180) to the frame side rail with two  $\frac{7}{16}$ -inch ID, 1-inch OD, 0.083-inch thick flat washers and  $\frac{3}{8} \times 1\frac{1}{2}$  lockwasher screws.
- (5) Secure the rear of the fender to the body cowl, from the engine side, with three  $\frac{5}{16} \times \frac{7}{8}$  lockwasher screws (fig. 178). Working beneath the body, install the bottom  $\frac{5}{16} \times \frac{7}{8}$  lockwasher screw through the body cowl into the fender.
- (6) Secure the front of the fender to the radiator guard with two  $\frac{5}{16} \times \frac{7}{8}$  lockwasher screws (fig. 179) at the top. Tighten the  $\frac{5}{16} \times \frac{7}{8}$  lockwasher screw at the bottom of the radiator guard.

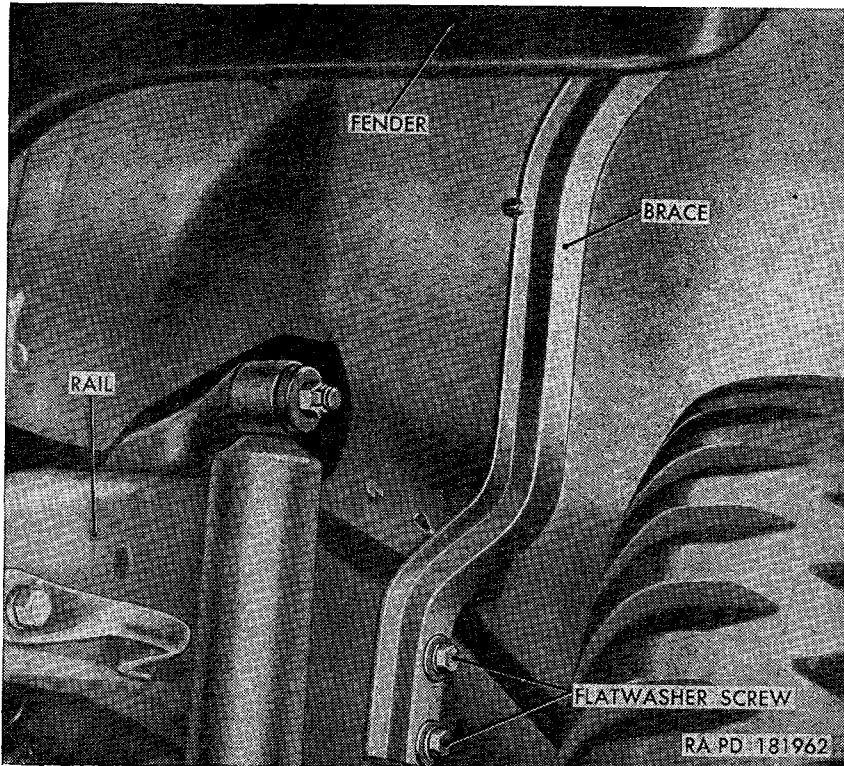

Figure 180. Fender brace of left front fender secured to frame left side rail (M38A1).

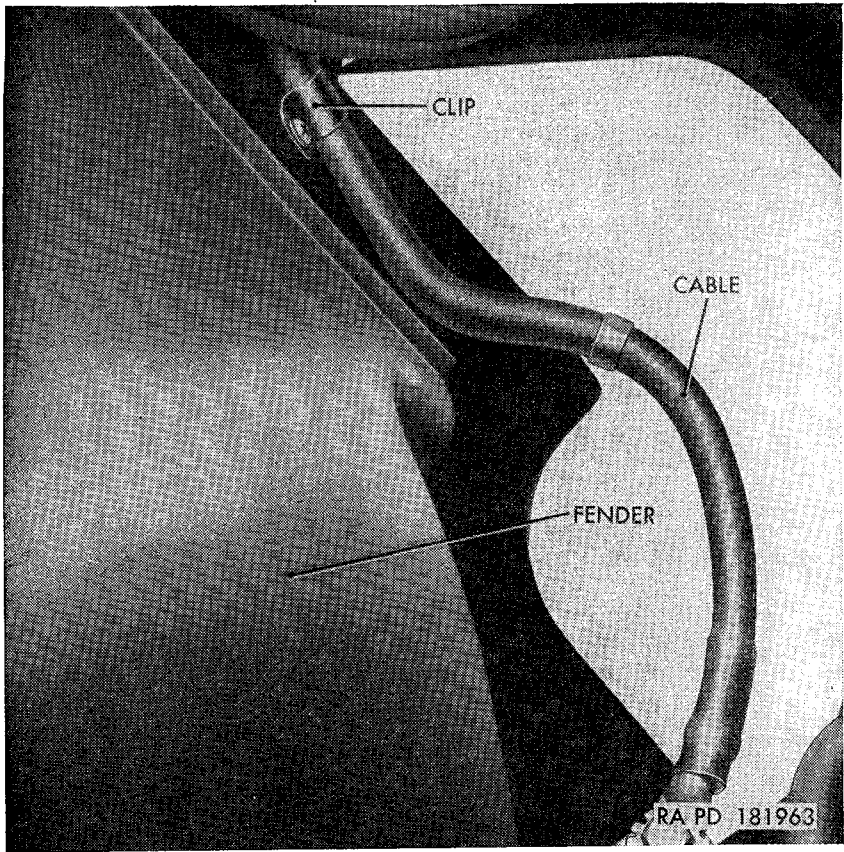

Figure 181. Battery ground cable secured to frame and fender.

- (7) Insert the fuel line into the clip on the fender. Insert the electrical cables into the four clips on the fender.
  - (8) Install horn assembly (par. 184*b*).
  - (9) Install blackout driving light assembly (par. 164*e*).
  - (10) Lower hood and lock in closed position (par. 255*b*).
- d. Right Front Fender Installation.*
- (1) Proceed as outlined in *c* (2) through (6) above.
  - (2) Secure the clip (fig. 181) on the battery ground cable to the fender splash apron with one No. 10-24 nut and No. 10-24 x 1/2 lockwasher screw.
  - (3) Lower hood and lock in closed position (par. 255*b*).

## 257. Radiator Guard With Deflector

### *a. Removal.*

- (1) Raise hood and lock in raised position (par. 255*a*).
- (2) Working on the inside of the left front fender, disconnect the electrical cables (fig. 182) leading to the headlights and the signal blackout marker and service parking light assemblies.



- (3) Working on the engine side of the radiator guard with deflector assembly, loosen the four  $\frac{5}{16} \times \frac{7}{8}$  lockwasher screws (two at each fender) securing the radiator guard to the left and right front fenders (fig. 179). Working beneath the fenders, loosen the  $\frac{5}{16} \times \frac{7}{8}$  lockwasher screw securing each fender to the radiator guard.
- (4) Remove the two bolts from the two radiator-to-guard panel "J" nuts (fig. 183) securing each side of the radiator guard to the radiator assembly.

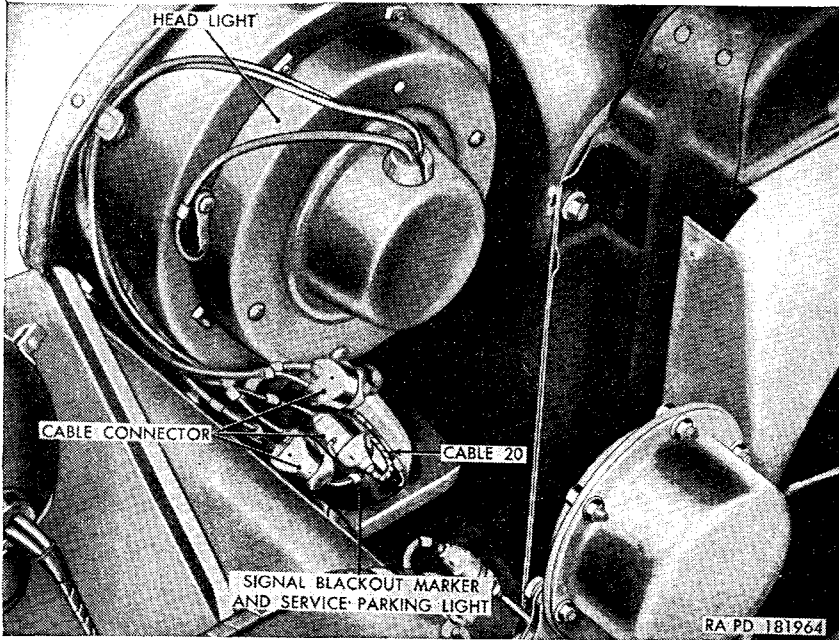

Figure 182. Electrical cables leading to left headlight assembly.

- (5) Swing the radiator guard forward until the slots in the radiator guard hinges are alined with the flat faces of the radiator guard hinge pins mounted on the frame side rails. Slip hinges off pins and remove radiator guard from vehicle.
- (6) Remove headlight assemblies from radiator guard (par. 163c).
- (7) Remove signal blackout marker and service parking light assemblies from radiator guard (par. 165b).

*b. Installation.*

- (1) Install signal blackout marker and service parking light assemblies on radiator guard (par. 165c).
- (2) Install headlight assemblies on radiator guard (par. 163d).
- (3) Place radiator guard in position at the front of the vehicle. Aline slots in the radiator guard hinges with the flat faces on

the radiator guard hinge pins mounted on the frame side rails and slide the slots on the pins. Raise guard into upright position, entering the two  $\frac{5}{16} \times \frac{7}{8}$  lockwasher screws on bottom of guard into the fender mounting slots and the four  $\frac{5}{16} \times \frac{7}{8}$  lockwasher screws into the guard mounting slots. Tighten all six screws.

- (4) Secure the radiator guard to the radiator by screwing two  $\frac{5}{16} \times \frac{5}{8}$  bolts into the two radiator-to-guard panel "J" nuts on each side of the guard (fig. 183).

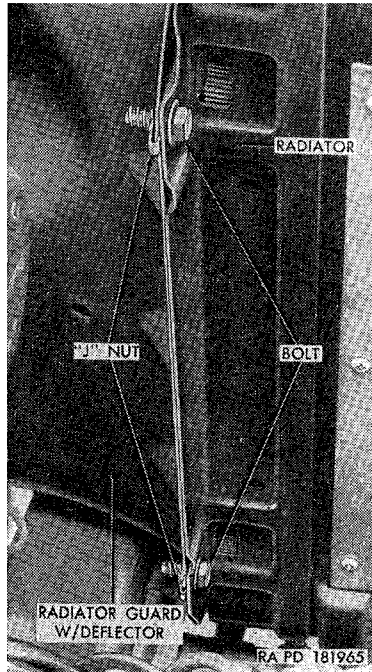

Figure 183. Radiator-to-guard panel "J" nuts—installed.

- (5) Working on the inside of the left front fender, connect the electrical cables (fig. 182) leading to the head lights and the signal blackout marker and service parking light assemblies.
- (6) Lower hood and lock in closed position (par. 255*b*).

## 258. Top Cover With Rear Curtain

### *a. Installation.*

- (1) Release the two top holddown straps securing the top bow assembly in the stored position (fig. 184). Unscrew the top bow pivot thumb screw with chain and ring assembly (fig. 184) at each rear top bow stowage bracket. Lift the top bow off the rear top bow stowage brackets and insert ends into the rear top bow sockets (fig. 184). Aline the mounting holes



in the flat ends with the mounting holes in the bow sockets. Working from the inside of the vehicle, insert thumb screws of the thumb screw and chain assemblies through the holes in the body and bows and screw into bow sockets.

- (2) Insert the angle-hooked end at the rear of the top rail into the hole in the front top bow. Insert the hooked end at the front of the top rail into the hole in the top rail bracket on the windshield frame. Secure the top rail in position at the top rail bracket by inserting pin of the chain assembly through hole in the hooked end at the front of the top rail. Repeat the procedure on the other side of the vehicle.

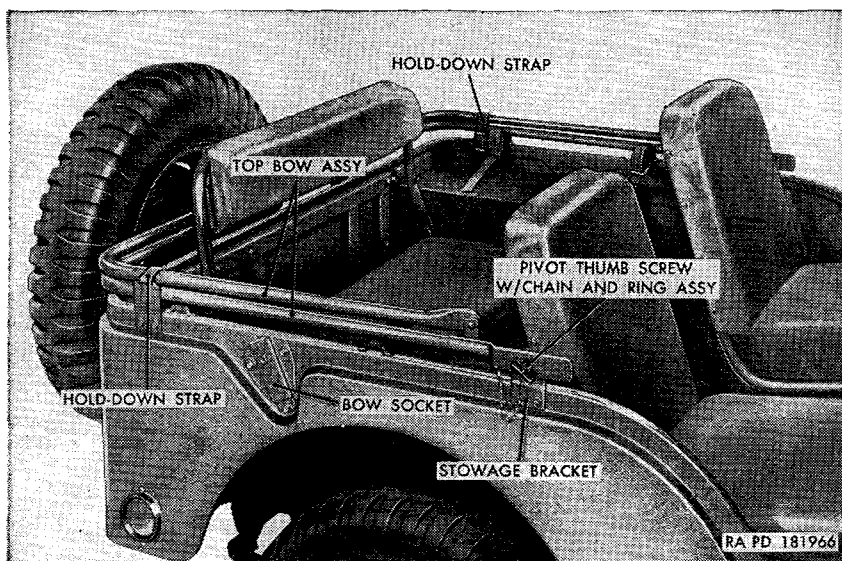
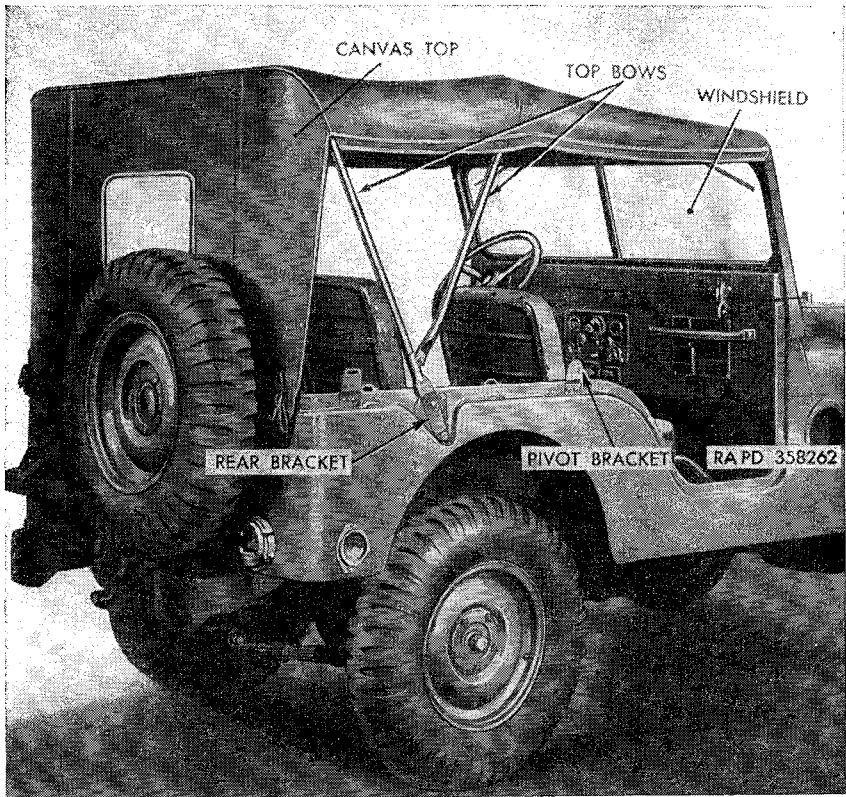

Figure 190. Left lifting shackle, bumperette, and towing pintle—installed.

- (3) Lay the top cover with rear curtain assembly (fig. 185) upside down and backward on top of hood assembly.
- (4) Insert the front bead of the top cover into one edge of the top retainer at the top of the windshield. Slide top bead of cover into retainer until bead is centered in place. Flip the top cover over the rear top bow and pull it down to the body rear panel. Secure the top cover to the panel by inserting the six top holddown straps through the six top holddown strap brackets and buckling straps. Secure the top cover bow by fastening the three flaps, mounted on the underside of the top cover, around the front top bow. Secure the top cover to the top rails by hooking the side flaps on the cover over the rails.

*b. Removal.*

- (1) Unbuckle the six holddown straps securing the top cover with rear curtain assembly (fig. 185) to the six top holddown strap brackets and pull the straps out of the brackets. Working inside the vehicle, release the three flaps securing the bottom of the top cover to the front top bow. Release the side flaps from the two top rails. Lift the rear of the top cover with rear curtain over the rear top bow and flip it over the wind-



*Figure 185. Top cover with rear curtain assembly—installed.*

- shield until it rests on the hood. Slide the front bead of the top cover out of the top retainer at the top of the windshield.
- (2) Withdraw the pin of the chain assembly from the hole at the front end of the top rail. Pull the front end out of the top rail bracket on the windshield frame. Pull the rear end of the top rail out of the hole in the front top bow. Repeat the procedure on the other side of the vehicle.
- (3) Fold the front top bow back until it rests against the rear top bow. Unscrew the thumb screw on the top bow pivot thumb screw with chain assembly out of the rear top bow socket

at each side of the vehicle. Lift the top bow assembly out of the rear top bow sockets. Place the top bow in a horizontal position on top of the body, aligning the mounting holes in the rear top bow with the mounting holes in the rear top stowage bracket at each side of the vehicle. Secure the top bow to the stowage bracket with the thumb screws of the top bow pivot thumb screw assemblies. Secure the top bow to the body by looping the two top holddown straps around the top bow and through the brackets on the body. Buckle the holddown straps.

- (4) Carefully fold and store the top cover with rear curtain assembly. Fold canvas smoothly to avoid cracks and tears.

## 259. Mirror, Reflectors, and Windshield Wipers

### a. Windshield wiper blade assembly (fig. 186).

- (1) *Removal.* Lift up on the windshield wiper adjustable arm assembly. Lift the lower end of the windshield wiper blade assembly to unlock the blade from the arm. Remove the blade.
- (2) *Installation.* Lift the windshield wiper adjustable arm up. Hook the windshield wiper blade, upside down into the arm, push the lower end of blade toward windshield, and lock blade in position. The position of the blade can be adjusted by loosening the adjusting screw at the end of the arm, setting blade in desired position, and tightening the screw.

### b. Windshield Wiper Adjustable Arm Assembly (fig. 186).

- (1) *Removal.* Remove the windshield wiper blade assembly (a(1) above). Unscrew the blind nut securing the wind-

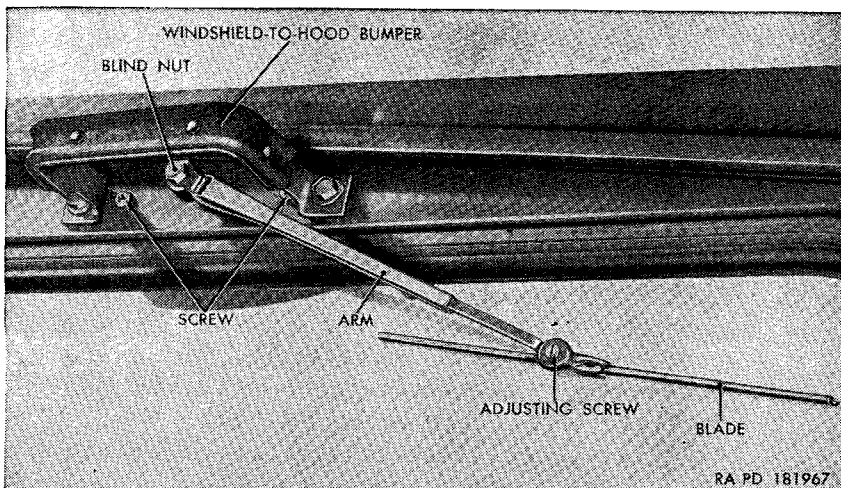

Figure 186. Windshield wiper blade and adjustable arm assemblies—installed.

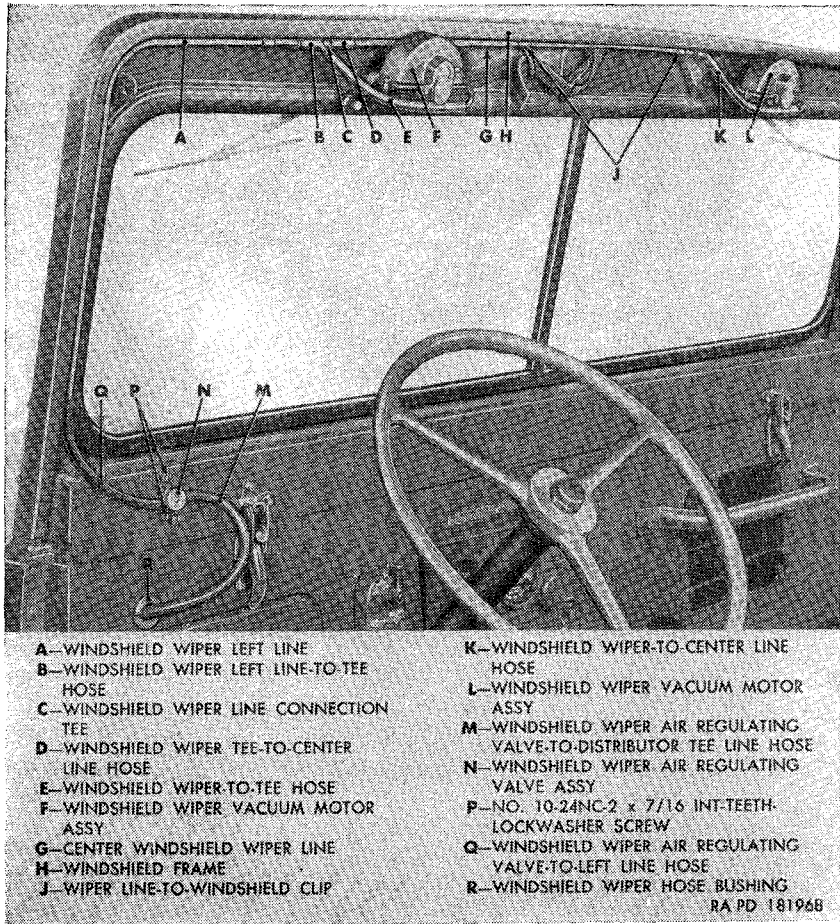

Figure 187. Windshield wiper vacuum motors—installed.

shield wiper adjustable arm assembly to the serrated shaft of the paddle within the windshield wiper vacuum motor assembly. Pull the arm off the shaft.

- (2) *Installation.* Position the windshield wiper adjustable arm on the serrated shaft of the paddle within the windshield wiper vacuum motor. Secure the arm to the shaft with one No. 10 blind nut. Install the windshield wiper blade assembly (a(2) above).

*c. Windshield Wiper Vacuum Motor Assembly.*

*Note.* Procedures in this paragraph apply to either windshield wiper vacuum motor assembly. The key letters noted in parentheses are in figure 187, except where otherwise indicated.

- (1) *Removal.* Remove the windshield wiper blade assembly (a(1) above). Remove the windshield wiper adjustable arm assembly (b(1) above). Pull the hose (windshield wiper-to-

tee for left motor and windshield wiper-to-center line for right motor) (E and K) from the fitting on the windshield wiper vacuum motor assembly (F and L). Remove one lockwasher screw from the windshield-to-hood bumper assembly (fig. 186), loosen the other lockwasher screw, and let one end of the bumper drop to permit removal of the screws securing the motor. Remove the two internal-teeth lockwasher screws securing the motor to the windshield frame. Remove the two windshield wiper mounting spacers and remove the motor from the frame.

- (2) *Installation.* Working inside the vehicle, insert the serrated shaft of the paddle within the windshield wiper vacuum motor through the hole in the windshield frame. Slide the hose (windshield wiper-to-tee for left motor and windshield wiper-to-center line for right motor) (E and K) onto the fitting on the motor. Working outside the vehicle, insert two No. 10-32NF-2 x  $\frac{7}{8}$  internal-teeth lockwasher screws into the windshield frame. From the inside of the windshield frame, insert one windshield wiper mounting spacer on each screw and screw into the motor. Secure the windshield-to-hood bumper (fig. 186) to the windshield frame with two  $\frac{1}{2}$  x  $\frac{1}{2}$  lockwasher screws. Install the windshield wiper adjustable arm (*b*(2) above). Install the windshield wiper blade (*a*(2) above). Start engine and check motor for proper operation.

*d. Windshield Wiper Lines and Hoses.*

*Note.* The key letters noted in parentheses are in figure 187, except where otherwise indicated.

- (1) *Left windshield wiper-to-tee and windshield wiper-to-center line hoses.*
  - (a) *Removal.* Pull the left end of the windshield wiper-to-tee hose (E) from the windshield wiper line connection tee (C). Pull the right end of the hose from the fitting on the left windshield wiper vacuum motor assembly (F) and remove the hose from vehicle. Pull the left end of the windshield wiper-to-center line hose (K) from the center windshield wiper line (G). Pull the right end of the hose from the fitting on the right windshield wiper vacuum motor assembly (L) and remove the hose from the vehicle.
  - (b) *Installation.* Slide one end of the left windshield wiper-to-tee hose (E) onto the windshield wiper line connection tee (C). Slide the other end of the hose onto the fitting on the left windshield wiper vacuum motor (F). Slide one end of the windshield wiper-to-center line hose (K) onto the center windshield wiper line (G). Slide the other

- end of the hose onto the fitting on the right windshield wiper vacuum motor (L).
- (2) *Center windshield wiper line, windshield wiper tee-to-center line hose, windshield wiper line connection, and windshield wiper left line-to-tee hose.*
- (a) *Removal.* Remove the two sheet metal screws securing the two wiper line-to-windshield clips (J). Pull the right end of the center windshield wiper line (G) out of the windshield wiper-to-center line hose (K). Pull the left end of the line out of the windshield wiper tee-to-center line hose (D). Pull the tee-to-center line hose off the windshield wiper line connection tee (C). Pull the left end of the left windshield wiper-to-tee hose (E) off the connection tee. Remove the connection tee by pulling it out of the windshield wiper left line-to-tee hose (B). Pull the hose off the windshield wiper left line (A).
- (b) *Installation.* Slide the windshield wiper left line-to-tee hose (B) onto the end of the windshield wiper left line (A). Insert the end of the windshield wiper line connection tee (C) into open end of the left line-to-tee hose. Slide the left windshield wiper-to-tee hose (E) onto the bottom arm of the connection tee. Slide the windshield wiper tee-to-center line hose (D) onto the upper arm of the connection tee. Insert one end of the center windshield wiper line (G) into the open end of the windshield wiper tee-to-center line hose (D). Insert the other end of the center windshield wiper line into the open end of the windshield wiper-to-center line hose. Secure the two wiper line-to-windshield clips (J) to the windshield frame with two No. 10 x ½ sheet metal screws.
- (3) *Left windshield wiper line.*
- (a) *Removal.* Remove the three sheet metal screws that secure the three wiper line-to-windshield clips (J) on the windshield wiper left line (A) to the windshield frame (H). Pull the upper end of the line out of the windshield wiper left line-to-tee hose (B). Pull the lower end of the line out of the windshield wiper air regulating valve-to-left line hose (Q) and remove the line.
- (b) *Installation.* Insert the lower end of the windshield wiper left line (A) into the windshield wiper air regulating valve-to-left line hose (Q). Insert the upper end of the line into the windshield wiper left line-to-tee hose (B). Secure the three wiper line-to-windshield clips (J) on the line to the windshield frame (H) with three No. 10 x ½ sheet metal screws.

(4) *Windshield wiper air regulating valve, air regulating valve-to-left line hose, and air regulating valve-to-distributor tee line hose.*

- (a) *Removal.* Pull the upper end of the windshield wiper air regulating valve-to-left line hose (Q) off the windshield wiper left line (A). Pull the lower end of the hose off the left extension on the windshield wiper air regulating valve (N) and remove hose. Pull the upper end of the windshield wiper air regulating valve-to-distributor tee line hose (M) off the extension on the right side of the air regulating valve. Open the hood and lock in raised position (par. 255a). Pull the lower end of the air reg-

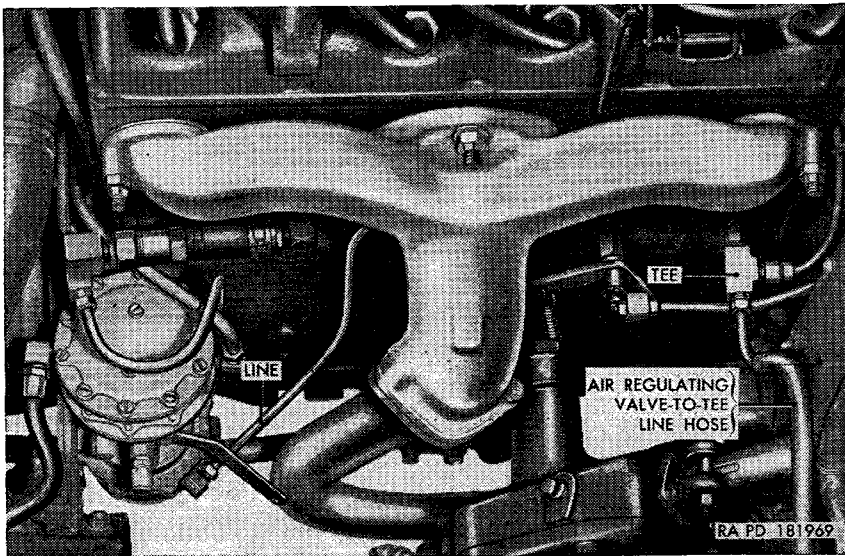

*Figure 188. Vacuum pump-to-tee line—installed.*

ulating valve-to-distributor tee line hose off the tee-to-windshield wiper line installed on the tee mounted on the vacuum pump-to-tee line (fig. 188). Remove the internal-teeth lockwasher screw securing the windshield wiper hose-to-cowl clip to the dash panel. Remove the air regulating valve-to-distributor tee line hose by pulling it through the instrument panel, glove compartment, dash panel, and clip. Remove the two internal-teeth lockwasher screws securing the windshield wiper air regulating valve (N) to the windshield frame and remove the valve. Remove two windshield wiper hose bushings (R) from the instrument panel and body cowl.

(b) *Installation.* Place the windshield wiper air regulating valve (N) in position, with extensions horizontal and lever pointing down, at the bottom of the windshield frame. Secure the valve to frame with two No. 10-24NC-2 x  $\frac{7}{16}$  internal-teeth lockwasher screws. Insert a  $\frac{13}{32}$ -inch diameter windshield wiper hose bushing into the wiper line hole in the body cowl. Insert a  $\frac{11}{16}$ -inch diameter windshield wiper hose bushing (R) into the wiper line hole in the instrument panel. Insert one end of the windshield wiper air regulating valve-to-tee line hose (M) through the instrument panel, glove compartment, and dash panel until it enters the engine compartment. Slide the windshield wiper hose-to-cowl clip onto the lower end of the hose. Slide the lower end of the hose onto the tee-to-windshield wiper line installed on the tee mounted on the vacuum pump-to-tee line (fig. 188). Secure the clip to the dash panel with one No. 10-24NF-2 x  $\frac{7}{16}$  internal-teeth lockwasher screw. Slide the end of the hose that is in the driver's compartment onto the right extension on the air regulating valve. Slide one end of the windshield wiper air regulating valve-to-left line hose (Q) onto the left extension on the air regulating valve. Slide the other end of the hose onto the lower end of the windshield wiper left line (A). Lower the hood and lock in closed position (par. 255b).

e. *Vacuum Pump-to-Tee Line.*

- (1) *Removal.* Raise the hood and lock in raised position (par. 255a). Unscrew the fitting on the vacuum pump-to-tee line (fig. 188) from the elbow at the bottom of the fuel and vacuum pump. Remove the safety nut securing the clip on the line to the lower right stud used to mount the exhaust manifold. Pull the clip off the stud. Unscrew the fitting on the line from the tee that is also mounted on the distributor-to-windshield wiper fitting vent line. Remove the line from the engine compartment. Slide the clip off the line.
- (2) *Installation.* Slide the clip onto the vacuum pump-to-tee line (fig. 188). Position the line within the engine compartment. Connect the fitting on the upper end of the line to the tee mounted on the distributor-to-windshield wiper fitting vent line. Install the clip on the lower right stud securing the exhaust manifold. Install one  $\frac{3}{8}$ -inch self-locking nut on the stud and tighten nut to a torque of 29-35 pound-feet. Connect the fitting at the lower end of the line to the elbow at the bottom of the fuel and vacuum pump. Lower hood and lock in closed position (par. 255b).



*f. Rear Reflex Reflectors (fig. 172).*

*Note.* Removal and installation procedures are the same for each of the three rear reflex reflectors mounted on the body.

- (1) *Removal.* Remove the two screws and internal-teeth lockwashers securing the rear reflex reflector to the body. Remove the reflector. Remove the three hub nuts securing the spare wheel and tire to the spare wheel support bracket and lift the wheel off the studs in the support bracket. Remove the two screws and lockwasher nuts securing the rear reflex reflector to the support bracket and remove the reflector.
- (2) *Installation.* Place the rear reflex reflector in place on the spare wheel support bracket and secure reflector to bracket with two  $\frac{1}{4} \times \frac{1}{2}$  screws and  $\frac{1}{4}$ -inch lockwasher nuts. Install the spare wheel and tire on the studs in the support bracket. Secure wheel to studs with three  $\frac{1}{2}$ -inch hub nuts. Place the rear reflex reflector in position on the body and secure reflector to body with two  $\frac{1}{4}$ -inch internal-teeth lockwashers and two  $\frac{1}{4} \times \frac{1}{2}$  screws.

*g. Outside Rear View Mirror Assembly (fig. 175).*

- (1) *Adjustment.* Loosen the locknut on the setscrew at the top of the rear view mirror arm. Loosen the setscrew and push the rear view mirror arm extension in or out of the arm, as desired. After setting the extension arm to the desired length, tighten the setscrew and lock it by tightening the locknut on the screw.
- (2) *Removal.* Remove four lockwasher screws securing the bracket of the outside rear view mirror assembly to the left side of the body cowl. Remove the mirror from the vehicle.
- (3) *Installation.* Position the bracket of the outside rear view mirror on the left side of the body cowl. Secure the bracket to the cowl with four  $\frac{1}{4} \times \frac{1}{2}$  lockwasher screws. Adjust length of rear view mirror arm extension if necessary ((1) above).

## **260. Lifting Shackles, Bumperettes, Towing Pintle, and Bumper Bar**

*a. Front Lifting Shackles and Brackets (fig. 189).*

*Note.* Removal and installation procedures are identical for both front lifting shackles and brackets.

- (1) *Removal.* Remove the snap clip from the hole in the end of the shackle pin. Withdraw the shackle pin from the front lifting shackle bracket and front lifting shackle, and remove the shackle from the bracket. Remove the two bolts and lockwashers securing the shackle bracket to the frame side

rail and bumper bar. Lift the shackle bracket off the side rail and bumper bar.

- (2) *Installation.* Position the front lifting shackle bracket, with the spacer end to the rear, on the frame side rail and bumper bar. Secure the bracket to the side rail and bumper bar with one  $1\frac{7}{32}$ -inch ID,  $\frac{7}{8}$ -inch OD lockwasher, and  $\frac{1}{2}$  x 2 bolt at the spacer end (rear) and one  $1\frac{7}{32}$ -inch ID,  $\frac{7}{8}$ -inch OD lockwasher and  $\frac{1}{2}$  x  $1\frac{1}{4}$  bolt at the front. Place the front lifting

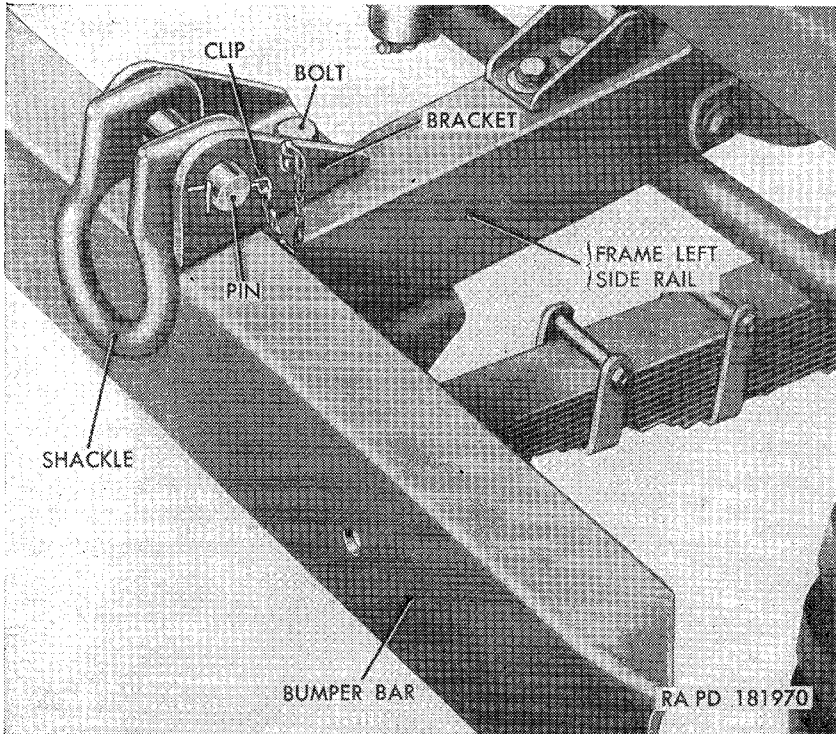

*Figure 189. Front lifting shackle and bracket—installed.*

shackle between the shackle bracket flanges so the shackle loop points down and the hole ends face toward vehicle. Install the shackle pin, inserting it from the side opposite to the snap clip chain, through the bracket and shackle. Lock pin in place by installing the snap clip.

*b. Rear Lifting Shackles and Brackets (fig. 190).*

*Note.* Removal and installation procedures are identical for both rear lifting shackles and brackets.

- (1) *Removal.* Remove the snap clip from the end of the shackle pin, withdraw the pin from the rear lifting shackle bracket

and shackle, and remove the shackle from the bracket. Remove the two bolts, nuts, lockwashers, and flat washers securing the rear lifting shackle bracket and spacer plate to the bumperette and frame rear cross member. Remove the bracket and spacer.

- (2) *Installation.* Insert two  $\frac{1}{2}$  x  $1\frac{1}{4}$  bolts into the rear lifting shackle bracket from the shackle side and place the spacer plate on the bolts from the frame side of the bracket. Align the holes in the bumperette and frame rear cross member with the bolts and insert the bolts through the holes, making

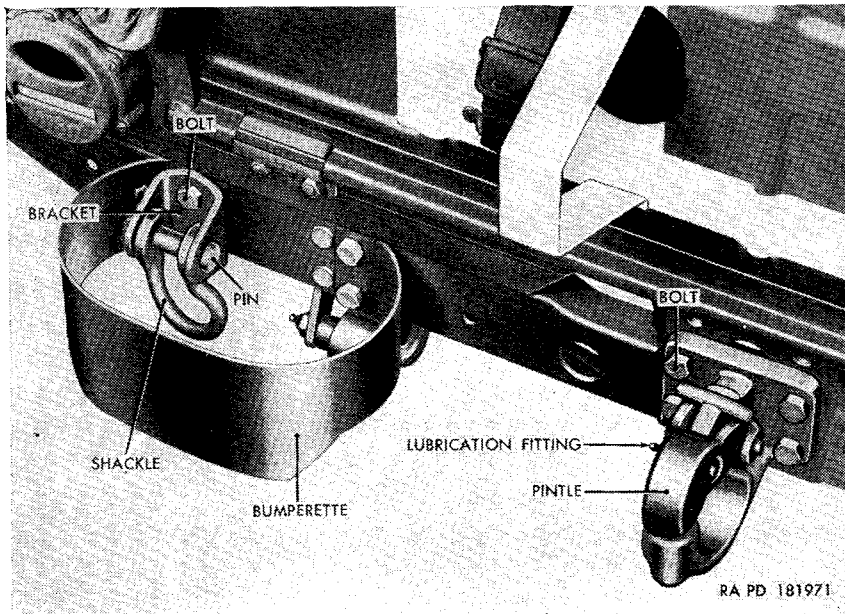

Figure 190. Left rear lifting shackle, bumperette, and towing pintle—installed.

sure the shackle bracket is positioned so the chain side faces away from center of frame. Secure the bracket to bumperette and rear cross member bracket to bumperette and rear cross member by installing a  $1\frac{7}{32}$ -inch ID,  $1\frac{1}{16}$ -inch OD flat washer,  $1\frac{7}{32}$ -inch ID,  $\frac{7}{8}$ -inch OD lockwasher, and  $\frac{1}{2}$ -inch nut on each bolt. Place the rear lifting shackle between the flanges of the shackle bracket, with the curved edge of the shackle loop facing the chain side of the bracket. Install the shackle pin, inserting it from the side of the bracket opposite the chain side, through the bracket and shackle pin. Lock the shackle pin in place by installing the snap clip.

*c. Bumperettes* (fig. 190).

*Note.* Removal and installation procedures are identical for both bumperettes.

- (1) *Removal.* Remove the rear lifting shackle and bracket (*b*(1) above). Remove the two bolts, nuts, and lockwashers securing the inner end of the bumperette to the frame rear cross member. Remove the bumperette.
- (2) *Installation.* Place the bumperette in position at the rear of the frame rear cross member. Secure the inner end of the bumperette to the cross member with two  $\frac{1}{2}$  x 1 bolts,  $1\frac{1}{32}$ -inch ID,  $\frac{7}{8}$ -inch OD lockwashers, and  $\frac{1}{2}$ -inch nuts. Install the rear lifting shackle and bracket (*b*(2) above).

*d. Towing Pintle Assembly* (fig. 190).

- (1) *Removal.* Remove the four bolts, lockwashers, and nuts securing the towing pintle assembly to the frame rear cross member and reinforcement. Remove the pintle. Unscrew the two lubrication fittings from the pintle.
- (2) *Installation.* Install two  $\frac{1}{4}$ -28NF lubrication fittings in the towing pintle assembly. Position the towing pintle in place at the rear of the vehicle. Secure the pintle to the frame rear cross member and reinforcement with four  $\frac{1}{2}$  x 2 bolts,  $\frac{1}{2}$ -inch lockwashers, and  $\frac{1}{2}$ -inch nuts.

*e. Bumper Bar* (fig. 189).

- (1) *Removal.* Remove the front lifting shackles and brackets (*a*(1) above). Remove the six bolts and lockwasher nuts securing the bumper bar to the frame side rail.
- (2) *Installation.* Position the bumper bar in place on the front of the two frame side rails. Secure the front of the bumper bar to each side rail with one  $\frac{3}{8}$  x  $\frac{7}{8}$  bolt and  $\frac{3}{8}$ -inch lockwasher nut. Secure bottom of bumper bar to each side rail with two  $\frac{3}{8}$  x  $\frac{7}{8}$  bolts and  $\frac{3}{8}$ -inch lockwasher nuts. Install the front lifting shackles and brackets (*a*(2) above).

## 261. Seats and Cushions

*a. Driver's Seat Assembly* (fig. 191).

- (1) *Removal.* Remove the four lockwasher screws and flat washers securing the driver's seat frame to the front and rear floor pans, left side body panel, and left rear wheel well panel.

*Note.* The screw securing seat to the wheel house is accessible from the underside of the well panel.

Lift the seat out of the driver's compartment.

- (2) *Installation.* Position the driver's seat over the fuel tank, aligning holes in the driver's seat frame with the mounting holes in the front and rear floor pans, left side body panel,

and the left rear wheel house. Secure the driver's seat frame to the front and rear floor pans with two  $1\frac{1}{32}$ -inch ID,  $\frac{11}{16}$ -inch OD, 0.065-inch thick flat washers and  $\frac{5}{16}$ -18 x  $\frac{7}{8}$  lockwasher screws. Secure the frame to the left side panel with a  $1\frac{1}{32}$ -inch ID,  $\frac{11}{16}$ -inch OD, 0.065-inch thick flat washer and  $\frac{5}{16}$ -18 x  $\frac{5}{8}$  lockwasher screw. Working on the underside of the wheel well panel, secure the frame to the panel with a  $1\frac{1}{32}$ -inch ID,  $\frac{11}{16}$ -inch OD, 0.065-inch thick flat washer and  $\frac{5}{16}$ -18 x  $\frac{5}{8}$  lockwasher screw.

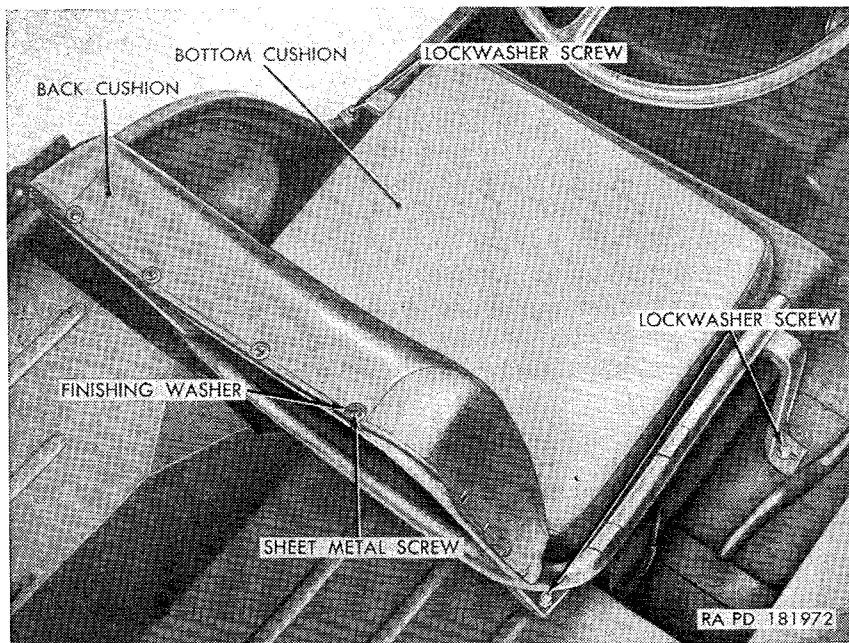

Figure 191. Driver's seat assembly (M38A1)—installed.

b. Passenger Seat Assembly (fig. 192).

- (1) *Removal.* Remove the front seat hinge pivot retaining pin from each of the two front seat hinge pivot pins. Tilt the passenger seat assembly forward until the flat sides on the pivot pins are aligned with the shaft retainer slots, and lift the seat out of the driver's compartment.
- (2) *Installation.* Position the passenger seat assembly over the pivot shaft retainers mounted on the top of the tool compartment, align the pivot pin flat sides with the retainer slots and insert the pivot pins into retainer. Tilt seat backward to lock it in place. Lock the pivot pins to the retainers by installing one front seat hinge pivot retaining pin in the end of each hinge pivot pin.

c. *Rear Seat Assembly* (fig. 193).

- (1) *Removal.* Remove four lockwasher screws from two rear seat retaining brackets and remove the brackets from the body. Lift up on the seat bottom, folding it toward the seat back, and set the seat assembly in the vertical position. Remove the lockwasher screw from the rear seat pivot shaft retainer plates at each end of the seat frame, and remove

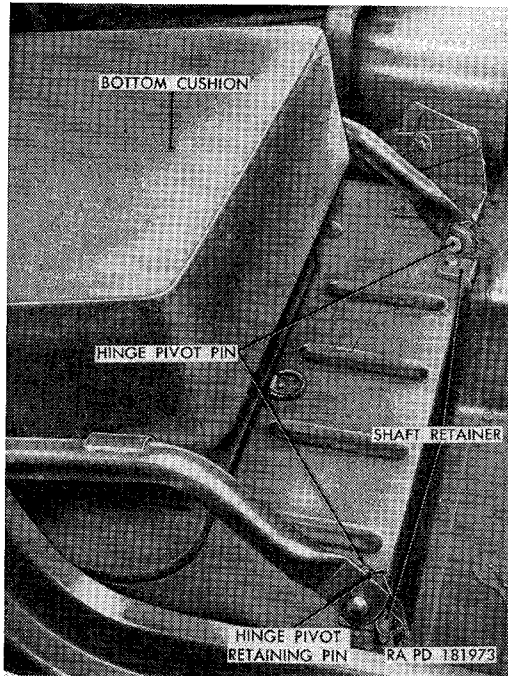

Figure 192. *Passenger seat assembly (M38A1)—installed.*

- the two retainer plates. Lift the seat straight up and out of the vehicle.
- (2) *Installation.* Fold the seat bottom up against the seat back. Position the ends of the rear seat pivot shaft into the two rear seat pivot shaft retainers. Place a rear seat pivot shaft retainer plate over each pivot shaft and secure each retainer plate to the body with a  $\frac{1}{4}$ -20 x  $\frac{1}{2}$  lockwasher screw. Lower the seat bottom into horizontal position. Position a rear seat retaining bracket at each side of the seat back and secure bracket with two  $\frac{1}{4}$ -20 x  $\frac{1}{2}$  lockwasher screws.

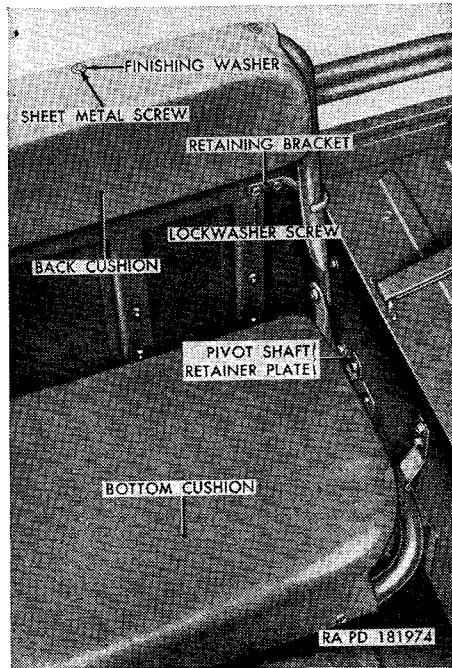

Figure 193. Rear seat assembly (M38A1)—installed—left side view.

d. Driver's and Passenger Seat Cushion Assemblies (figs. 191 and 192).

- (1) *Removal.* Remove driver's seat assembly (a(1) above). Remove passenger seat assembly (b(1) above).

*Note.* Procedures for removing the front seat cushion assemblies are identical after the respective seats have been removed from the vehicle.

Remove the two lockwasher screws securing the bottom of the seat bottom cushion to the bottom of the seat frame, push the cushion up and forward away from the frame and remove the cushion from frame. Remove the 12 sheet metal screws and finishing washers securing the seat back cushion to the top of the seat frame, and lift cushion off the frame.

- (2) *Installation.* Place the seat bottom cushion on the bottom of the seat frame, align the two integral mounting clips with the mounting brackets on the frame, and slip the cushion into position on the frame. Secure the bottom cushion to the bottom of the frame with two  $\frac{5}{16} \times \frac{5}{8}$  lockwasher screws. Position the seat back cushion at the top of the seat frame and secure cushion to frame with twelve No. 12 finishing washers and No. 10  $\times \frac{1}{2}$  sheet metal screws. Install the driver's seat assembly (a(2) above). Install the passenger seat assembly (b(2) above).

*e. Rear Seat Cushion Assemblies (fig. 193).*

- (1) *Removal.* Remove the rear seat assembly (*c*(1) above). Remove the 10 sheet metal screws securing the rear seat bottom cushion to the bottom of the rear seat frame and lift cushion off the frame. Remove the 10 sheet metal screws and finishing washers securing the rear seat back cushion to the top of the rear seat frame, and remove the cushion.
- (2) *Installation.* Position the rear seat bottom cushion on the bottom of the rear seat frame and secure cushion to frame with ten No. 10 finishing washers and No. 10 x 1/2 sheet metal screws. Position the rear seat back cushion at the top of the rear seat frame and secure cushion to frame with ten No. 10 finishing washers and No. 10 sheet metal screws.

## **Section XXVI. BODY AND FRAME (M170)**

### **262. Description and Data**

*a. Description.*

- (1) *Body.* The body (fig. 198) is an all steel, open-type of seamed and welded construction. The body is equipped with a driver's seat (fig. 201), front passenger seat, wheel house cushions (fig. 202), tool compartment, two medical supplies stowage compartments, battery stowage box, and bows for the installation of the top cover, side curtains, and doors. A well in front of the right wheel house provides for mounting the spare wheel and tire inside the body. A strap is provided in front of the spare wheel mounting well for stowing spare fuel can. A two-piece, folding-type windshield, with two windshield wiper vacuum motors, is secured to the body cowl. The formed sheet metal hood and front fenders are removable. Access to the rear of the engine compartment, transmission, transfer, master cylinder, and steering gear is provided by removable front floor pan covers and access plates. Reflex reflectors are bolted to the rear and sides of the body.

*Note.* Refer to paragraphs 53 through 58 for description and operation of ambulance equipment.

- (2) *Frame.* The frame is constructed of two heavy channel steel side rails and five cross members. The side rails and cross members are reinforced with welded plates. Two rear reinforcements of a V-shape design are welded to the side rails and rear cross member. All cross members, except the engine rear support cross member, are welded to the side rails. A stabilizer bar is mounted at each end of the frame to reduce swaying. Two front lifting shackles and a bumper bar are



mounted on the front of the frame. A towing pintle, two rear lifting shackles, and two bumperettes are mounted on the rear of the frame. Brackets and supports provide mounts for the engine, body, shock absorbers, springs, and stabilizer bars.

*b. Data.*

Body:

Construction..... welded  
Driver's position..... left  
Length..... 88 $\frac{3}{8}$  in.  
Type..... all steel, open  
Width..... 55.40 in.  
Windshield type..... two piece, folding

Frame:

Length..... 148.44 in.  
Material..... SAE 1020  
Number of cross members..... 5  
Width..... 29.25 in.

### 263. Windshield Assembly

The procedures for lowering and raising the windshield assembly of the M170 are identical to those of the M38A1 (par. 254*a* and *b*).

### 264. Hood Assembly

The raising, lowering, removal and installation procedures for the hood assembly of the M170 are identical to those of the M38A1 (par. 255).

### 265. Front Fenders

*a. Left Front Fender Removal.* The removal procedures for the left front fender of the M170 are identical to those of the M38A1 (par. 256*a*) with the exceptions listed in (1), (2), and (3) below.

- (1) The fuel line is not clipped to the fender (par. 256*a*(4)).
- (2) The fender brace is cut off and not connected to the frame side rail (par. 256*a*(7)).
- (3) The upper and lower front fender-to-cowl side panel anti-squeak (webbing) is not used (par. 256*a*(9)).

*b. Right Front Fender Removal.* The removal procedures for the right front fender of the M170 are identical to those of the M38A1 (par. 256*b*) except that no fender brace disconnections must be made (par. 256*b*(5)).

*c. Left Front Fender Installation.* The installation procedures for the left front fender of the M170 are identical to those of the M38A1 (par. 256*c*) with the exceptions listed in (1), (2), and (3) below.

- (1) Coat surface of fender that mates with the body cowl with seal (WO-669709) instead of installing the lower and upper antisqueak (webbing) (par. 256*c*(2)).

(2) No fender brace connections must be made (par. 256c(4)).

(3) No fuel line connection must be made (par. 256c(7)).

*d. Right Front Fender Installation.* The installation procedures for the right front fender of the M170 are identical to those of the M38A1 (par. 256d) with the exceptions listed in (1) and (2) below.

(1) Coat surface of fender that mates with the body cowl with seal (WO-669709) instead of installing the lower and upper antisqueak (webbing) (par. 256c(2)).

(2) No fender brace connections must be made (par. 256c(4)).

## 266. Radiator Guard With Deflector

### *a. Removal.*

(1) Proceed as directed in paragraph 257a(1) through (4).

(2) Loosen the outer lockwasher nut (fig. 194) on each of the two dash-to-air deflector tie rods sufficiently so that flat washers on the rod will clear the projections on the air deflector of the radiator guard with deflector. Pull the rods outward until they are clear of the deflector.

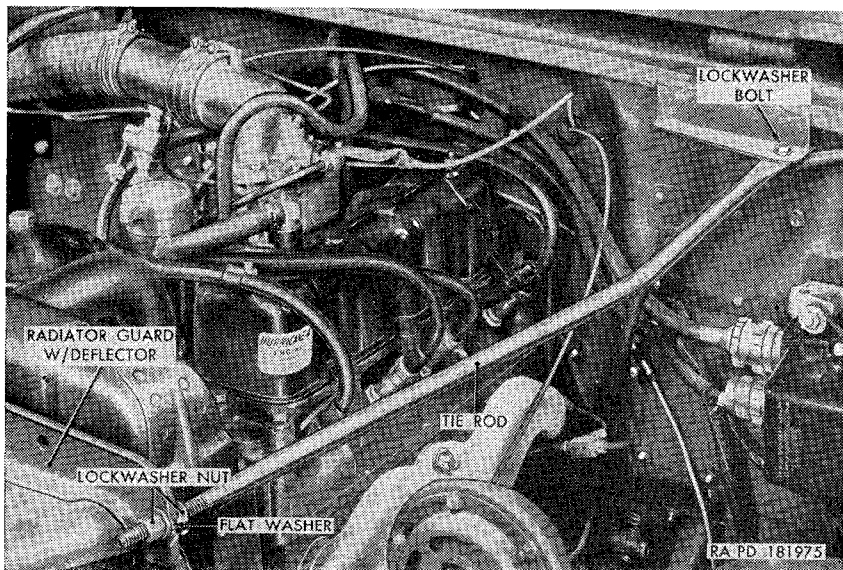

Figure 194. Dash-to-air deflector tie rod—installed on left side of radiator guard.

(3) Remove the locknut and flat washer from the bolt (fig. 195) securing the bottom of the radiator guard with deflector to the bracket on the frame front cross member. Remove the bolt and flat washer from the guard and bracket. Pull the radiator guard forward until the guard slots are clear of the fender screws. Remove the guard from the vehicle.

- (4) Pull the rubber washer from the bottom of the spacer installed in the bracket on the frame front cross member. Lift the other rubber washer with the spacer from the top of the bracket.
  - (5) Remove the nut and lockwasher bolt (fig. 194) securing the rear of each tie rod to the bracket on the dash. Remove the two tie rods.
  - (6) Proceed as directed in paragraph 257a(6) and (7).
- b. Installation.*
- (1) Proceed as directed in paragraph 257b(1) and (2).

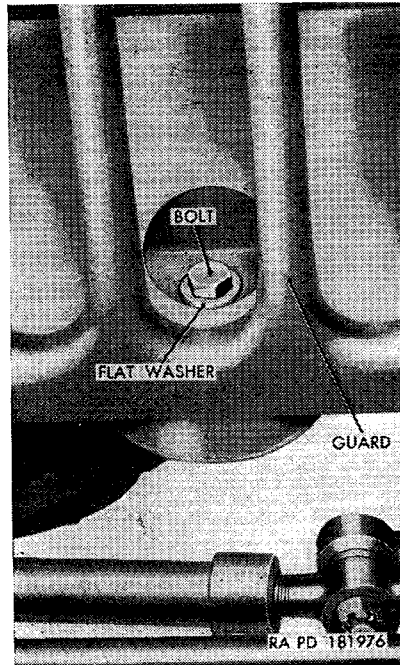

Figure 195. Radiator guard with deflector—bottom connection.

- (2) Install the spacer in the opening provided in the bracket on the frame front cross member. Install one rubber washer on the top end of the spacer.
- (3) Place the radiator guard with deflector in position at the front of the vehicle. Aline the hole at the bottom of the guard with the spacer hole, install one  $\frac{7}{16}$ -inch flat washer on the  $\frac{7}{16} \times 2\frac{1}{4}$  bolt (fig. 195) and insert the bolt through the guard and spacer. Install one  $\frac{7}{16}$ -inch ID, 2-inch OD flat washer, and  $\frac{7}{16}$ -inch locknut on the bolt, but do not tighten nut at this time.

- (4) Enter the two lockwasher screws on the bottom of the guard into the mounting slots in the fenders. Enter the four lockwasher screws in the fenders into the mounting slots of the guard. Tighten all six screws.
- (5) Tighten the  $\frac{7}{16}$ -inch locknut installed on the bolt at the bottom of the guard.
- (6) Secure guard to radiator by screwing two  $\frac{5}{16} \times \frac{5}{8}$  bolts into the radiator-to-guard panel clips on each side of guard.
- (7) Position the flat end of each dash-to-air deflector tie rod on the bottom of the bracket on the dash. Secure each rod to bracket with one  $\frac{5}{16} \times \frac{7}{8}$  lockwasher bolt (fig. 194) and  $\frac{5}{16}$ -inch nut.

*Note.* Install rod with the short bend on the right side of the engine compartment so the bend is up and over the air cleaner-to-air intake pipe flexible hose. Install rod with the long bend on the left side of the engine compartment so the bend is down.

- (8) Insert the front end of each rod between the projections on the deflector of the guard, making sure a flat washer is on each side of the projection. Tighten the outer  $\frac{3}{8}$ -inch lockwasher nut (fig. 194) on each rod to brace the guard.
- (9) Proceed as directed in paragraph 257b (5) and (6).

## 267. Stabilizer Bars, Brackets, and Links (M170)

(fig. 196)

### a. Removal.

- (1) *Bar (rear)*.
  - (a) Remove the cotter pin and nut at the upper end of the link on the right and the left side of the vehicle.
  - (b) Remove the cup shaped washer and the link grommet from the links.
  - (c) Swing the bar up and off the links and remove the grommet and cup shaped washer from the links.
  - (d) Remove the four nuts, lockwashers, and bolts securing the mounting bracket to the support bracket on the frame, and remove the bar assembly from the vehicle.
- (2) *Support bracket (rear)*. Remove the six nuts, lockwashers, and bolts securing the support brackets to the frame side rail and remove the brackets from the vehicle.
- (3) *Links*.
  - (a) Follow procedure in a(1) (a), (b), and (c) above.
  - (b) Remove the cotter pin and flat washer from the link shaft of the U-bolt plate and slide the link with the link bushing off the shaft, and remove a flat washer from the shaft.
- (4) *Bar (front)*. The procedure for removing the front stabilizer bar is the same as the rear ((1) above) except that the mounting brackets are secured directly to the frame side rail.

*b. Installation.*

(1) *Links.*

(a) Install a flat washer and the link with the link bushing over the link shaft of the U-bolt plate. Install a flat washer over the link shaft and secure with a  $\frac{1}{8}$  x 1 cotter pin.

(b) Follow procedure in (3) (b) through (e) below.

(2) *Support bracket (rear).* Position the support brackets on the frame side rails. Install three  $\frac{7}{16}$  x 1 bolts through each bracket and the frame side rail and secure with  $\frac{7}{16}$ -inch lockwasher and nut.

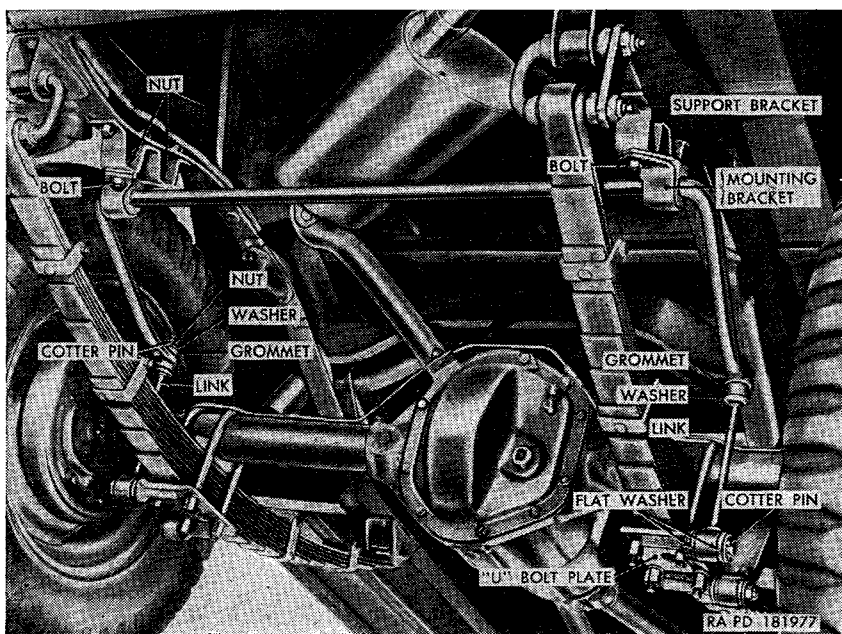

Figure 196. Stabilizer bar, brackets, and links (M170)—Rear.

(3) *Bar (rear).*

(a) Position the mounting brackets on the support brackets and install two  $\frac{7}{16}$  x 1 bolts through the brackets on each side. Install a  $\frac{7}{16}$ -inch lockwasher and  $\frac{7}{16}$ -inch nut on the bolts securing the mounting brackets to the support brackets.

(b) Install a cup shaped washer and a grommet over the link on each side.

(c) Swing the bar down and slide the eyelet on each end of the bar over the links.

(d) Install a grommet and cup shaped washer over the end of each link.

- (e) Install a  $\frac{3}{8}$ -inch nut on each link and tighten until a slight bulge appears in the grommets and the nut slot is alined with the link hole, and install a  $\frac{3}{32} \times 1$  cotter pin.
- (4) *Bar (front)*. The procedure for installing the front stabilizer bar is the same as the rear ((3) above) except that the mounting brackets are secured directly to the frame side rail.

## **268. Top Cover With Rear Curtain, Side Curtains, and Doors**

### *a. Door Removal (fig. 197).*

*Note.* Both the right and left doors are removed in the same manner.

- (1) Unfasten the lower front portion of the door curtain from the body cowl by unfastening the four turn buttons and lifting curtain free of buttons.
- (2) Open the door and lift up on the door hinge until the lower end of hinge clears the hole in the top of the body side panel.
- (3) Pull lower end of hinge outward to clear side panel and then downward until upper end of hinge is clear of bracket on windshield.
- (4) Continue to pull downward on the door until the head at the front of the door curtain is clear of the side retainer on the side of the windshield, and remove the door.

### *b. Door Installation (fig. 197).*

*Note.* Both the right and left doors are installed in the same manner. The left door is provided with a hand opening that is opened and closed with a zipper.

- (1) Insert the top of the bead at the front of the door curtain into the side retainer on the side of the windshield. Shove the bead up into the retainer until the upper end of the door hinge is alined with the bottom of the bracket on the windshield.
- (2) Insert hinge into bracket hole and push hinge upward until the lower end of the hinge clears the top of the body right side panel.
- (3) Aline the lower end of the hinge with the hole in the top of the side panel and insert hinge into hole.
- (4) Secure the lower front portion of the door curtain to the body cowl with the four turn buttons.

### *c. Side Curtain Removal (fig. 197).*

- (1) Unfasten the rear of the right side curtain from the side of the rear curtain by opening the halves of the zipper on the side and rear curtains.
- (2) Unfasten the bottom of the side curtain from the body side panel by unfastening the holddown straps from the footman loops on the panel.

*Note.* The right side curtain has four holddown straps while the left side curtain has only three.

- (3) Lift the lower end of the right side curtain front rod from the body right side panel hole.
- (4) Pull the rod and curtain outward so that rod clears side panel, and follow by pulling the rod downward until it is free of the bracket at the middle of the right top rail and the fold on the front of curtain.
- (5) Unfasten the four turn buttons securing the two flaps at the rear of the curtain to the right rear side top bow, and free the flaps from the buttons and bow.
- (6) Unfasten the top of the curtain from the top cover by unfastening the seven turn buttons on the top cover, and remove the curtain from the vehicle. Proceed in a similar manner to remove the left side curtain.

*d. Side Curtain Installation (fig. 197).*

- (1) Position the top of the right side curtain between the flaps on the right side of the top cover.
- (2) Secure the curtain to the top cover with the seven turn buttons.
- (3) Position the two flaps at the rear of the curtain around the right rear side top bow, and secure each flap in place with four turn buttons.
- (4) Insert one end of the right side curtain front rod through the bottom of the fold at the front of the curtain. Shove the rod through the fold and through the hole in the bracket at the middle of the right top rail. Push the rod through the bracket until the lower end clears the top of the body right side panel.
- (5) Aline the lower end of the rod with the hole in the top of the side panel and insert lower end of rod into hole.
- (6) Secure the bottom of the curtain to the side panel by inserting the four hold-down straps at the bottom of the curtain through the footman loops on the panel and then buckling the straps.

*Note.* The left side curtain, the smaller of the two side curtains, has only three holddown straps.

- (7) Secure the rear of the right side curtain to the side of the rear curtain by closing the halves of the zipper on the side and rear curtains, making sure to start the zipper fastener from the top. Proceed in a similar manner to install the left side curtain.

*e. Top Cover with Rear Curtain Removal (fig. 197).*

- (1) Unfasten the bottom of the rear curtain from the tail gate and body rear panel by unfastening the four holddown straps from the footman loops on the tail gate and panel.

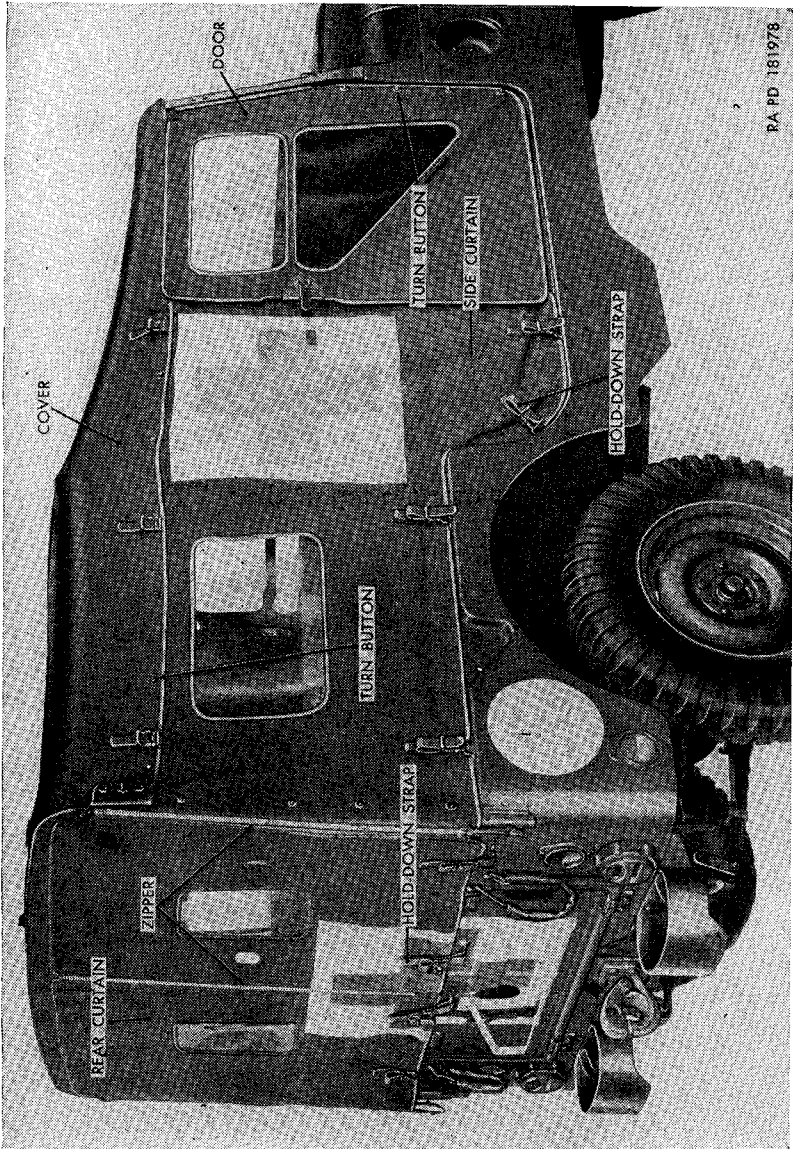

PA PD 181978

Figure 197. Top cover with rear curtain, right side curtain, and right door—installed.



- (2) Unfasten the turn button securing each end flap at the rear of the top cover to the top cover and free the flap from the button.
- (3) Unfasten the side flaps from the right and left top rails by unfastening the three turn buttons securing each flap.
- (4) Flip the rear curtain forward over the center rear top bow and follow by flipping the rear curtain and top cover over the vehicle and over the windshield until it rests on the hood.
- (5) Slide the top retainer cover front bead on the top of the windshield. Remove the top cover with rear curtain from vehicle.

*f. Top Cover with Rear Curtain Installation (fig. 197).*

- (1) Position the top cover with rear curtain on top of the hood so that cover is upside down and with its front end nearest windshield.
- (2) Beginning at either side of the windshield, insert the cover front bead into the top retainer edge at the top of the windshield, and slide the bead into retainer until bead is centered in place.
- (3) Flip the top cover over the top of the vehicle and over the center rear top bow.
- (4) Secure the rear curtain of the top cover to the tail gate and rear body panel by fastening the four holddown straps on the curtain to the footman loops on the tailgate and body panel.
- (5) Position the side flaps at the front of the top cover around the right and left top rails and secure each flap with three turn buttons.
- (6) Flip the end flaps at the rear of the top cover forward and secure each flap to the top cover with the turn button provided on the side of the cover.

*Note.* The end flaps are fastened around the ends of the center rear top bow with two turn buttons when the side curtains are not used.

*g. Top Rails Removal (fig. 198).*

- (1) Withdraw the pin, chained to the right top rail, from the hole at the rail front end and pull the end free of the bracket on the windshield.
- (2) Lift the rail rear end out of the bracket hole at the top of the right front side top bow, and remove the rail from the vehicle. Proceed in a similar manner to remove the left top rail from the vehicle.

*h. Top Rails Installation (fig. 198).*

- (1) Insert the right top rail end (without hole) through the bracket hole at the top of the right front side top bow.

- (2) Insert the other rail end through the bracket hole at the top of the windshield, and lock the rail in place by inserting the pin, chained to the rail, through the hole at the rail end. Proceed in a similar manner to install the left top rail on the left side of the vehicle.

*i. Side and Center Top Bows Removal (fig. 198).*

- (1) Remove the two nuts, flat washers, and step bolts securing the front-to-rear top bow stabilizer board to the center front and rear top bows, and remove the board from the vehicle.
- (2) Remove the two nuts, flat washers, and step bolts securing the windshield-to-front top bow stabilizer board to the windshield and center front top bow, and remove the board from the vehicle.
- (3) Unfasten the two door stowage straps on the center front top bows from the windshield brackets. Lift up on the front top bow until its ends are clear of the openings at the tops of the right and left front side top bows, and remove the front top bow from the vehicle.
- (4) Lift up on the center rear top bow until ends are clear of the openings at the tops of the right and left rear side top bows, and remove the rear top bows from the vehicle.
- (5) Remove the two nuts, flat washers, and step bolts securing each of the two wheel house seat back rests to the front and rear side top bows, and remove the back rests from the vehicle.
- (6) Lift the left front side top bow, left rear side top bow, and front side top bow out of the bow sockets on the body panels.
- (7) Remove the two bolts and lockwashers securing the right rear side top bow bracket to the body rear panel. Lift the bow from the bow socket on the right rear cover of the body and remove bow from vehicle.

*j. Side and Center Top Bows Installation (fig. 198).*

- (1) Insert the lower end of the right rear side top bow, with the bracket end down, into the bow socket at the right rear corner of the body. Secure the bracket at the lower end of the bow to the body rear panel with two  $\frac{5}{16}$ -inch plain washers,  $\frac{5}{16}$ -inch lockwashers, and  $\frac{5}{16} \times \frac{3}{4}$  bolts.
- (2) Insert the end of the right front side top bow into the bow socket in front of the right wheel house, making sure not to insert the end that has the auxiliary litter stowage strap.
- (3) Insert the left rear side top bow into the bow socket at the left rear corner of the body.
- (4) Insert the left front side top bow into the bow socket on the body left side panel at the rear of the driver's seat.
- (5) Position one wheel house seat back rest on the inner sides of the brackets on the right front and rear side top bows, and

- secure the rest to the brackets with two  $\frac{5}{16} \times \frac{7}{8}$  step bolts,  $\frac{5}{16}$ -inch flat washers, and  $\frac{5}{16}$ -inch nuts, making sure to insert bolts from the outside. Proceed in a like manner to install the wheel house seat back rest on the left side of the vehicle.
- (6) Insert the center rear top bow ends into the right and left rear side top bow tops, making sure that bracket at center of bow points forward.
  - (7) Insert the center front top bow ends into the right and left front side top bow tops, making sure that the door stowage straps are at the left. Fasten the straps to the two brackets on the windshield.
  - (8) Position the windshield-to-front top bow stabilizer board in place beneath the bracket at the top center of the windshield and the bracket at the front of the center front top bow, secure in place with two  $\frac{5}{16} \times \frac{7}{8}$  step bolts,  $\frac{5}{16}$ -inch flat washers, and  $\frac{5}{16}$ -inch nuts, making sure to insert bolts from the top.
  - (9) Position the front-to-rear top bow stabilizer board beneath the brackets on the center front top bow and center rear top bow, and secure in place with two  $\frac{5}{16} \times \frac{7}{8}$  step bolts,  $\frac{5}{16}$ -inch flat washers, and  $\frac{5}{16}$ -inch nuts, making sure that the plasma container hooks point to the left of the vehicle.

## 269. Litter Racks

### *a. Upper Litter Rack.*

- (1) *Removal.* Working in the driver's compartment, withdraw the upper litter rack front inner locking pin (fig. 199) from the hole in the bracket front side on the upper litter rack underside to unlock the rack inner side from the upper litter front support. Withdraw the upper litter rack front outer locking pin from the bracket on the rack front outer side and the bracket on the front support to unlock the rack outer side from the front support. Push the middle of the upper litter rack front spreader arm forward to unlock it. Pull the rack inner side toward the outside of the vehicle until it is up against the rack outer side. Working at the rear of the vehicle, withdraw the upper litter rack rear outer locking pin (fig. 200) from the bracket on the rack outer side and the support bracket on the right rear side top bow. Push the middle of the upper litter rack rear spreader arm to the rear to unlock it. Slide the rack inner side toward the outside of the vehicle until it is up against the rack outer side. Unhook the upper litter rack hanger from the center rear top bow. Remove the rack from within the vehicle.
- (2) *Installation.* Position the upper litter rack within the vehicle so that rack front end rests on the upper litter front

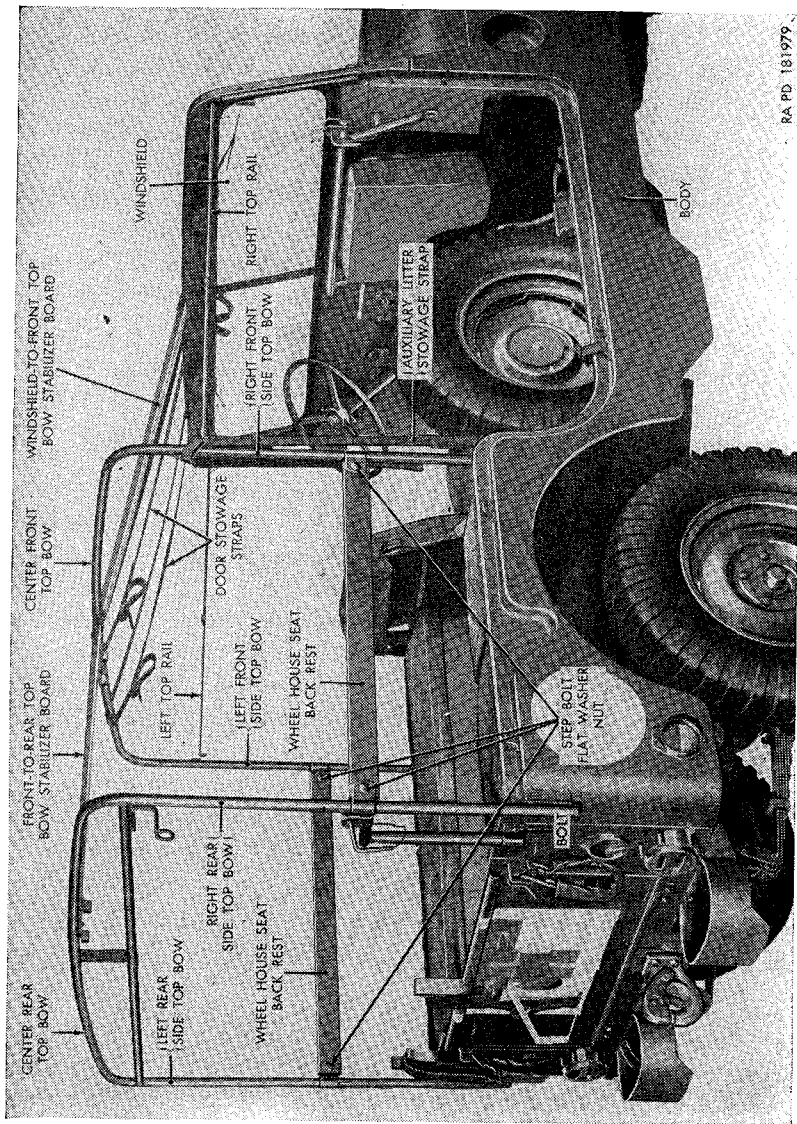

RA PD 181979

Figure 198. Side and center top bows and side rails—installed.

support and the rear of the inner side rests on the support of the right rear side top bow. Hook the upper litter rack hanger (fig. 200) over the center rear top bow. Lock the rack inner side to the support bracket on the rear side top bow by inserting the upper litter rack rear outer locking pin through the support bracket and the bracket on the rack outer side. Working in the driver's compartment, lock the rack outer side to the upper litter front support, by inserting the upper litter rack front outer locking pin (fig. 199) through the bracket on the rack front outer side and the bracket on the support. Lock the rack inner side to the support by inserting the upper litter rack front inner locking pin through the front side of the bracket on the rack underside. Push the rack inner side toward the center of the vehicle. Lock the rack in extended position by locking the upper litter rack front and rear spreader arms.

*Note.* To lock front spreader arm, push middle of arm toward rear of vehicle. To lock the rear spreader arm, push middle of arm toward front of vehicle.

*b. Lower Litter Rack.*

- (1) *Removal.* Working from the beneath the vehicle, remove the four lockwasher screws and flat washers securing each rack side to the floor pan. Remove the two sides of the lower litter rack from within the vehicle.
- (2) *Installation.* Position the two sides of lower litter rack on the floor pan of the vehicle, with the litter rack stops forward. Working beneath the vehicle, secure each rack side to the floor pan with four  $\frac{5}{16}$ -inch flat washers and  $\frac{5}{16} \times \frac{3}{4}$  lockwasher screws.

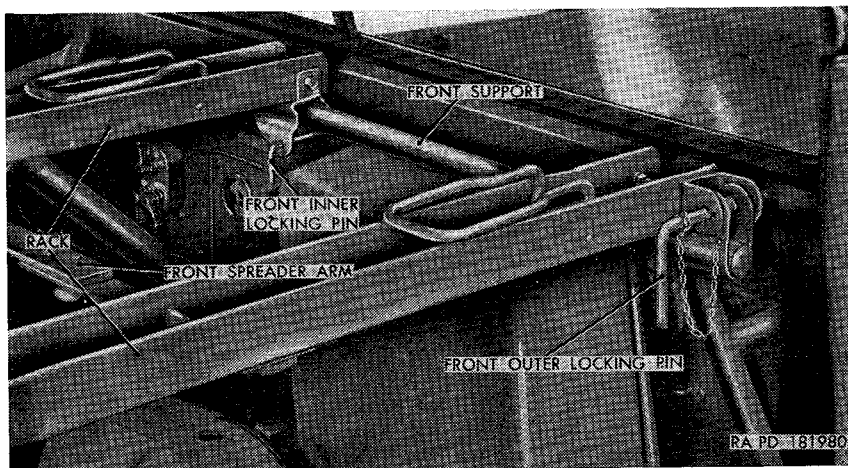

Figure 199. Upper litter rack front connections.

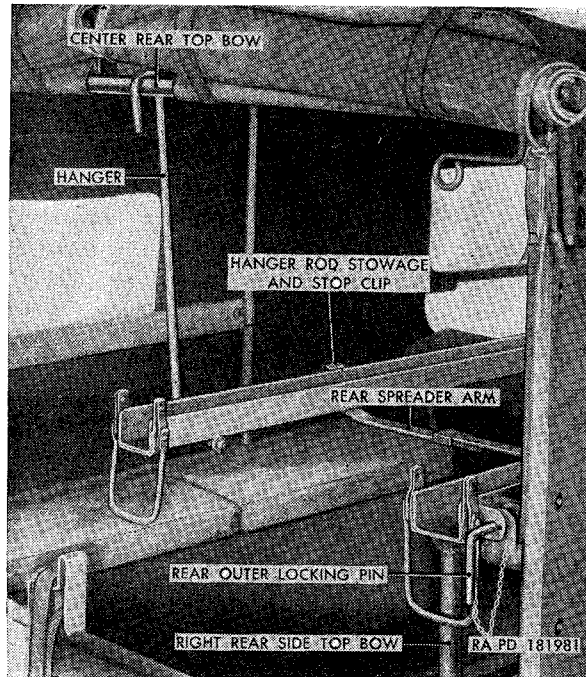

Figure 200. Upper litter rack rear connections.

## 270. Mirror, Reflectors, and Windshield Wipers

The removal and installation procedures for the windshield wiper blade, adjustable arm and vacuum motor assemblies, windshield wiper lines and hoses, vacuum pump-to-tee line, rear reflex reflectors, and outside rear view mirror assembly of the M170 are identical to those of the M38A1 (par. 259).

## 271. Lifting Shackles, BUMPERETTES, Towing Pintle, and Bumper Bar

The removal and installation procedures for the front lifting shackles and brackets, rear lifting shackles and brackets, bumperettes, towing pintle assembly, and bumper bar of the M170 are identical to those of the M38A1 (par. 260) except that a spring tension washer is used between the left side of the right rear lifting shackle and the right side of the shackle bracket on the M170.

## 272. Seats and Cushions

a. *Driver's seat* (fig. 201).

- (1) *Removal.* Tilt the driver's seat forward and align the flat sides of the pivot pins, mounted in the seat legs, with the flat faces of the seat hinge pivots on the floor pan. Lift the seat until the pins are free of the pivots, and remove seat from vehicle.

- (2) *Installation.* Position the driver's seat in an upright position within the driver's compartment. Aline the flat sides of the pivot pins with the flat faces of the seat hinge pivots, and insert the pins into the pivots. Tilt the seat rearward until the frame rests on the floor pan.

*b. Passenger Seat.*

- (1) *Removal.* Remove the front passenger seat cushion as directed in paragraph 261*d*(1). Remove the two lockwasher screws and flat washers securing the front passenger seat pivot brackets to the floor pan. Push the front passenger crash pad and cover forward until the locking bracket on the seat

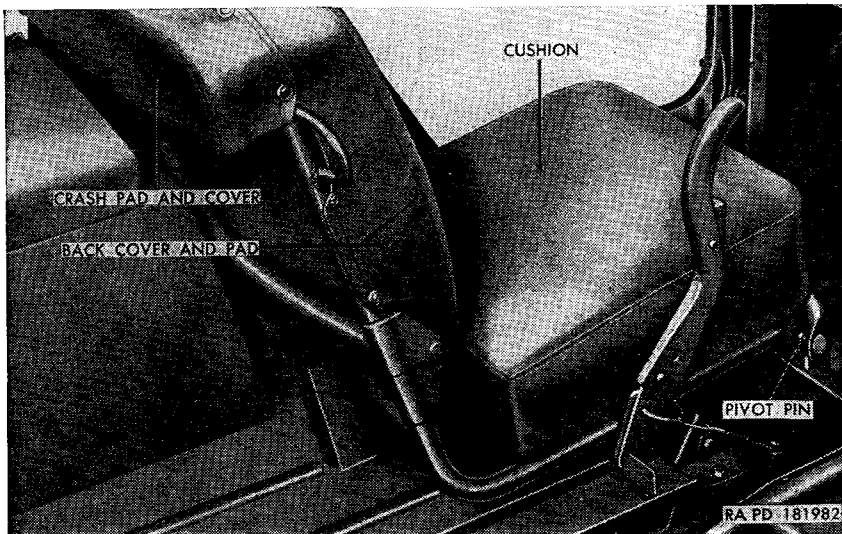

Figure 201. Driver's seat—installed

frame is free of the footman loop on the floor pan. Remove the front passenger crash pad and cover and the seat back cover and pad from the vehicle.

- (2) *Installation.* Place the front passenger seat back cover and pad and the crash pad and cover in position within the driver's compartment. Secure the front passenger seat pivot brackets to the floor pan with two  $\frac{5}{16}$ -inch flat washers and  $\frac{5}{16} \times \frac{3}{4}$  lockwasher screws. Move the front passenger crash pad and cover forward until the locking bracket on the seat frame engages the footman loop on the floor pan. Position the front passenger seat cushion within the driver's compartment so that the pivot pins are over the seat hinge pivots on the floor pan. Aline the flat sides of the pins with the flat faces of the pivots and insert the pins into the pivots. Tilt cushion rearward until the frame rests on the floor pan.

c. *Wheel House Cushions* (fig. 202).

- (1) *Removal.* Remove the four oval-head tapping screws and finish washers securing each of the two right wheel house cushions to the top of the right wheel house and remove cushions from within vehicle. Remove the five oval-head tapping screws and finish washers securing each of the two left wheel house cushions to the top of the left wheel house and remove the cushions from the vehicle.
- (2) *Installation.* Position the two right wheel house cushions on the top of the right wheel house and secure each one with four No. 10 finish washers and No. 10 x 1/2 oval-head tapping screws. Position the two left wheel house cushions on top

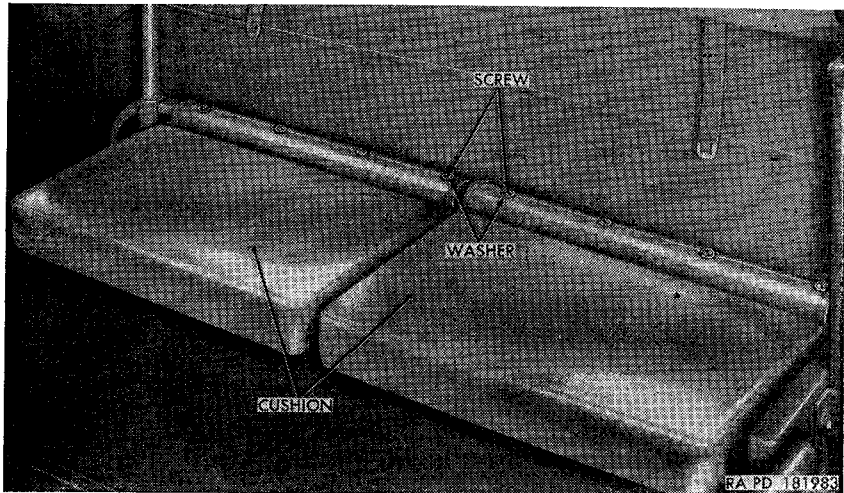

Figure 202. *Right wheel house cushions—installed.*

of the left wheel house and secure each one with five No. 10 finish washers and No. 10 x 1/2 oval-head tapping screws.

d. *Driver's seat cushion.*

- (1) *Removal.* Remove the driver's seat (*a*(1) above). Remove the four oval-head cross recess screws securing the driver's seat cushion to the seat frame and remove the cushion from the frame.
- (2) *Installation.* Position the driver's seat cushion on the seat frame and secure cushion to frame with four No. 10 x 1/2 oval-head cross recess screws. Install the driver's seat (*a*(2) above).

e. *Driver's Seat Frame Crash Pad and Cover.*

- (1) *Removal.* Remove the driver's seat (*a*(1) above). Remove the 11 oval-head tapping screws and finish washers securing



the driver's seat frame crash pad and cover to the seat frame, and remove the crash pad and cover from the frame.

*Note.* The seven top screws also secure the driver's seat back cover and pad to the frame.

Remove the driver's seat frame crash pad from the driver's seat frame crash pad cover.

- (2) *Installation.* Place the driver's seat frame crash pad within the driver's seat frame crash pad cover and position the pad and cover in place on the seat frame. Secure the cover and pad to the frame with 11 No. 10 finish washers and No. 10 x  $\frac{1}{2}$  oval-head tapping screws. Install the driver's seat (*a*(2) above).

*f. Driver's Seat Back Cover and Pad.*

- (1) *Removal.* Remove the driver's seat (*a*(1) above). Remove the 14 oval-head tapping screws and finish washers securing the driver's seat back cover and pad to the seat back frame, and remove the cover and pad.

*Note.* The seven top screws also secure the driver's seat frame crash pad and cover to the frame.

Remove the driver's seat back pad from the driver's seat back cover.

- (2) *Installation.* Place the driver's seat back pad within the driver's seat back cover and position pad and cover on the seat back frame. Secure the cover and pad to the frame with 14 No. 10 finish washers and No. 10 x  $\frac{1}{2}$  oval-head tapping screws. Install the driver's seat (*a*(2) above).

*g. Front Passenger Seat Cushion.*

- (1) *Removal.* Remove the front passenger seat cushion (par. 261d(1)). Remove the four oval-head cross recess screws securing the front passenger seat cushion to the seat frame, and remove the cushion from the frame. Remove the two oval-head cross recess screws securing the footman loop and passenger seat stowage strap to the seat cushion pan, and remove the footman loop and stowage strap.

- (2) *Installation.* Position the footman loop and front passenger seat stowage strap on the seat cushion pan and secure in place with two No. 10 x  $\frac{5}{8}$  oval-head cross recess screws. Position the front passenger seat cushion on the seat frame and secure cushion to frame with four No. 10 x  $\frac{1}{2}$  oval-head cross recess screws. Install the front passenger seat cushion (*b*(2) above).

*h. Front Passenger Seat Back Cover and Pad.*

- (1) *Removal.* Remove the front passenger seat (*b*(1) above). Remove the nine oval-head tapping screws and finish washers securing the front passenger seat back cover and pad to the

seat back frame and remove the cover and pad from frame. Remove the front passenger seat back pad from the front passenger seat back cover.

- (2) *Installation.* Place the front passenger seat back pad within the front passenger seat back cover and position the pad and cover on the seat back frame. Secure the cover and pad to the frame with nine No. 10 finish washers and No. 10 x ½ oval-head tapping screws. Install the front passenger seat (b(2) above).

*i. Front Passenger Seat Frame Crash Pad and Cover.*

- (1) *Removal.* Remove the front passenger seat (b(1) above). Remove the seven oval-head tapping screws and finish washers securing the front passenger seat frame crash pad and cover to the seat frame. Pull the three trim clips on the cover free of the frame and remove the cover and pad. Remove the front passenger seat frame crash pad from the cover.
- (2) *Installation.* Place the front passenger seat frame crash pad within the front passenger seat frame crash pad cover and position pad and cover on seat frame. Secure the pad and cover to frame with seven No. 10 finish washers and No. 10 x ½ oval-head tapping screws. Insert the trim clips on the cover into the holes in the frame. Install the front passenger seat (b(2) above).

## **Section XXVII. MAINTENANCE UNDER UNUSUAL CONDITIONS**

### **273. Extreme-Cold Weather Maintenance Problems**

*a.* The importance of maintenance must be impressed on all concerned, with special emphasis on organizational (preventive) maintenance. Maintenance of mechanical equipment in extreme cold is exceptionally difficult in the field. Even shop maintenance cannot be completed with normal speed, because the equipment must be allowed to thaw out and warm up before the mechanic can make satisfactory repairs. In the field, maintenance must be undertaken under the most difficult of conditions. Bare hands stick to cold metal. Fuel in contact with the hands results in super-cooling due to evaporation, and the hands can be painfully frozen in a matter of minutes. Engine oils, except subzero grade, are unpourable at temperatures below -40° F. Ordinary greases become as solid as cold butter.

*b.* These difficulties increase the time required to perform maintenance. At temperatures below -40° F., maintenance requires up to five times the normal amount of time. The time required to warm up a vehicle so that it is operable at temperatures as low as =50° F. may approach 2 hours. Vehicles in poor mechanical condition probably will not start at all, or only after many hours of laborious main-

tenance and heating. Complete winterization, diligent maintenance, and well-trained crews are the key to efficient arctic-winter operations.

c. Refer to TM 9-2855 for general information on extreme-cold weather maintenance procedures.

d. Refer to TB 9-2855-3 for information on winterization kit for this vehicle.

## 274. Extreme-Cold Weather Maintenance

Refer to TM 9-2855 for a general discussion of maintenance problems, the application of antifreeze compounds and arctic-type lubrication, handling of storage batteries in extreme cold, and dewinterization procedure.

## 275. Extreme-Hot Weather Maintenance

a. *Cooling System.* Thoroughly clean and flush cooling system (TM 9-2858) at frequent intervals and keep system filled to within an inch of the overflow pipe with clean water when operating in extremely high temperatures. Formation of scale and rust in the cooling system occurs more rapidly during operation in extremely high temperatures; therefore, corrosion-inhibitor compound should always be added to the cooling liquid. Avoid the use of water that contains alkali or other substances which may cause scale and rust formations. Use soft water whenever possible.

### b. Batteries.

- (1) *Electrolyte level.* In torrid zones, check level of electrolyte in cells daily and replenish, if necessary, with pure distilled water. If this is not available, rain or drinking water may be used. However, continuous use of water with high mineral content will eventually cause damage to batteries and should be avoided.
- (2) *Specific gravity.* Batteries operating in torrid climates should have a weaker electrolyte than for temperate climates. Instead of 1.280 specific gravity as issued, the electrolytic (sulphuric acid, sp gr 1.280) should be diluted to 1.200 to 1.240 specific gravity (TM 9-2857). This is the correct reading for fully-charged batteries. This procedure will prolong the life of the negative plates and separators. Batteries should be recharged at about 1.160 specific gravity.
- (3) *Self-discharge.* A battery will self-discharge at a greater rate if left standing for long periods at high temperatures. This must be considered when operating in torrid zones. If necessary to park for several days, remove the batteries and store in a cool place.

*Note.* Do not store acid-type storage batteries near stacks of tires, as the acid fumes have a harmful effect on rubber.

*c. Chassis and Body.*

- (1) In hot, dry climates, a careful watch must be kept for evidence of the presence of moths and termites.
- (2) In hot, damp climates, corrosive action will occur on all parts of the vehicle and will be accelerated during the rainy season. Evidences will appear in the form of rust and paint blisters on metal surfaces and mildew, mold, or fungus growth on wood, fabrics, leather, and glass.
- (3) Protect all exposed exterior painted surfaces from corrosion by touchup painting and keep a film of engine lubricating oil (OE-10) on unfinished exposed metal surfaces. Cables and terminals should be protected by ignition-insulation compound.
- (4) Make frequent inspections of idle, inactive vehicles. Remove corrosion from exterior metal surfaces with abrasive paper or cloth and apply a protective coating of paint, oil, or suitable rust preventive.

## **276. Maintenance After Fording**

*a. General.* Although the vehicle unit housings are sealed to prevent the free flow of water into the housing, it must be realized that, due to the necessary design of these assemblies, some water may enter, especially during submersion. The following services should be accomplished on all vehicles which have been exposed to some depth of water or completely submerged, especially in salt water. Precautions should be taken as soon as practicable to halt deterioration and avoid damage before the vehicle is driven extensively in regular service.

*b. Body and Chassis.* Drain and clean out body, engine, and tool compartment; clean all exposed painted surfaces and touchup paint where necessary. Coat unpainted metal parts with engine lubricating oil (OE-10). Lubricate the chassis thoroughly as directed in the lubrication chart. Do more than the *usual* lubrication job, making sure the lubricant is forced in to each lubrication point to force out any water present.

*c. Engine, Transmission, Transfer Case, and Axles.* Check the lubricant in the engine, transmission, transfer case, and axles. Should there be evidence that water has entered, drain, flush, and refill with the correct lubricant. Remove and clean engine and transmission oil filter.

*d. Wheels and Brakes.* Remove the front wheels and flush out the knuckle housings with a half-and-half mixture of engine oil (OE-10) and dry-cleaning solvent or volatile mineral spirits. Refill to filler plug level with the correct lubricant. Remove rear wheels. Wash all wheel bearings thoroughly with dry-cleaning solvent or volatile mineral spirits, after which repack, assemble, and adjust. While the

wheels are removed, dry out brake linings and clean rust and scum from brake drum face. Check brake system for presence of water.

*e. Batteries.* Check the batteries for quantity and specific gravity of electrolyte to be sure no water has entered through the vent caps. This is of special importance should the vehicle have been submerged in salt water.

*f. Steering Gear.* Remove and disassemble steering gear. If the lubricant is contaminated, clean the housing thoroughly with a half-and-half mixture of engine oil OE-10) and dry-cleaning solvent or volatile mineral spirits. Assemble, refill with correct grade of lubricant, and adjust (par. 230).

*g. Electrical Connections.* Check all electrical connections for corrosion, particularly the bayonet-type connectors.

*h. Fuel System.* Drain fuel tank of any accumulated water; clean fuel filter and lines as necessary. If water is found in the air cleaner, clean and refill with oil.

*i. Distributor.* Remove the distributor cam and check to determine if any water has entered the distributor. If water is present, drain, clean, and lubricate the distributor as required.

*j. Condensation.* Although most units are sealed, the sudden cooling of the warm interior air upon submersion may cause condensation of moisture within the cases or instruments. A period of exposure to warm air after fording should eliminate this fault. Cases which can be opened may be uncovered and dried.

*k. Aluminum or Magnesium Parts.* If vehicle remains in salt water for any appreciable length of time, aluminum or magnesium parts which were exposed to the water will probably be unfit for further use and must be replaced.

*l. Deep-Water Fording.* Refer to TM 9-2853 for deep-water fording information.

## **277. Maintenance After Operation on Unusual Terrain**

*a. Mud.* Thorough cleaning and lubrication of all parts affected must be accomplished as soon as possible after operation in mud, particularly when a sea of liquid mud has been traversed. Clean radiator fins and interior of engine compartment. Repack bearings if necessary. Clean, oil, and stow tire chains in vehicle.

*b. Sand or Dust.* Clean engine and engine compartment. Touch up all painted surfaces damaged by sandblasting. Lubricate completely to force out lubricants contaminated by sand or dust. Air cleaners and oil filters must be cleaned at least daily. Radiator fins should be cleaned daily with compressed air when operating in dusty terrain. Engine and other exposed vents should be covered with cloth at all times. When halted, engine grilles should be covered to protect the engine against entrance of sand or dust.

## Section XXVIII. RADIO INTERFERENCE SUPPRESSION

### 278. Purpose

*a.* Radio interference suppression is the elimination or minimizing of the electrical disturbances which interfere with radio reception or disclose the location of the vehicle to sensitive electrical detectors. It is important, therefore, that vehicles with, as well as vehicles without, radios be suppressed properly to prevent interference with radio reception of neighboring vehicles.

*b.* Suppression in this vehicle is accomplished by the use of metallic shielding, capacitors, resistor suppressors, choke, filter, and rectifier. Wiring that may carry interfering surges to a point where interference will affect radio reception is shielded.

### 279. Description

The ignition and generating system have been designed to accomplish suppression of radio interference. The ignition system radio interference suppression is accomplished by a primary capacitor in the distributor wiring harness receptacle, resistor suppression in the spark plugs, and shielded spark plug cables. Radio interference suppression in the generating system is accomplished by a choke, capacitor, filter, and rectifier in the generator regulator assembly.

### 280. Ignition System Radio Interference Suppression

*a. Description.* The primary capacitor is housed in the distributor wiring harness receptacle (fig. 79) and is an integral part of the primary circuit. Spark plugs are shielded individually by metallic braid beneath the rubber insulation.

*b. Maintenance.*

- (1) *Primary capacitor.* Procedure for the replacement of the primary capacitor is outlined in paragraph 151*d*.
- (2) *Spark plug suppressors.* The spark plug suppressors are an integral part of the spark plugs. If interference is caused by the spark plugs, the plugs must be replaced (par. 153*c* and *d*).
- (3) *Spark plug cables.* The spark plug cables must be replaced if the rubber insulation or the metallic shielding is damaged (par. 153*a* and *b*).

### 281. Generating System

*a. Description.* The generator regulator assembly houses the capacitor, choke, filter, and rectifier.

*b. Maintenance.* The replacement of the capacitor, choke, filter, and rectifier is the responsibility of ordnance maintenance personnel. If interference is originating in the generating system, refer to paragraph 91*d*.

## **282. Fasteners and Bond Straps**

Four ground straps (fig. 91) are secured to the mounting bracket cushions that support the generator regulator assembly. These straps form a shield about the generator regulator. The engine front plate-to-frame ground strap shields the power plant. It is important that all straps be in good condition and tightly secured to form a good ground.

## CHAPTER 4

# SHIPMENT AND LIMITED STORAGE AND DESTRUCTION OF MATERIEL TO PREVENT ENEMY USE

---

### Section I. SHIPMENT AND LIMITED STORAGE

#### 283. Domestic Shipping Instructions

*a. Preparation for shipment in zone of interior.* When shipping the ¼-ton 4 x 4 utility truck M38A1 and ambulance M170 interstate or within the zone of interior, except directly to ports of embarkation, the officer in charge of preparing shipments *will be responsible* for furnishing the vehicle to carriers for transport in a *serviceable* condition, properly cleaned, preserved, painted, and lubricated as prescribed in SB 9-4.

*Note:* For loading and blocking instructions for these vehicles on flatcars, see paragraphs 285 and 286. On-vehicle material (OVM) will be processed, packaged, and stowed as prescribed in paragraph 285*b*.

*b. Removal of Preservatives before Shipment.* Personnel withdrawing vehicles from limited storage for domestic shipment *must not remove preservatives*, other than to insure that the vehicles are complete and serviceable. If it has been determined that preservatives have been removed, they must be restored prior to domestic shipment. Removal of preservatives is the responsibility of depots, ports, and field installations receiving shipment.

*c. Preparation for Shipment to Ports* (see AR 747-30).

- (1) *Inspection.* All used vehicles destined for oversea use will be inspected, prior to shipment, in accordance with TB ORD 385.
- (2) *Processing for shipment to ports.* All vehicles destined to ports of embarkation for oversea shipment will be further processed in accordance with SB 9-4.

*Note:* Ports of embarkation will perform any necessary supplementary or previously omitted processing upon receipt of vehicles, in accordance with AR 747-30.

- (3) *Marking of arctic-lubricated material.* It will be the responsibility of the officer in charge of the organization performing arctic lubrication to insure that the equipment is marked as prescribed in SR 746-30-10. It will be the re-



sponsibility of the officer in charge of the organization shipping arctic-lubricated equipment to insure that each item is so marked. Unit commanders of using organizations will insure that such markings are not obliterated while the equipment is arctic-lubricated. When the equipment is deprocessed of the special lubrication, such marking will be immediately and thoroughly obliterated.

*d. Army Shipping Documents.* Prepare all Army shipping documents accompanying freight in accordance with TM 38-705.

*e. Deep-Water Fording.* If deep-water fording is anticipated during shipment, prepare vehicles in accordance with TM 9-2853.

## **284. Limited-Storage Instructions**

### *a. General.*

- (1) Vehicles received for storage and already processed for domestic shipment, as indicated on DA Form 9-3, Processing Record for Shipment and Storage of Vehicles and Boxed Engines, must not be processed unless inspection performed, on receipt of vehicles, reveals corrosion, deterioration, etc.
- (2) Completely process vehicles upon receipt directly from manufacturing facilities or if processing data recorded on tag indicate that preservatives have been rendered ineffective by operation or freight shipping damage.
- (3) Vehicles to be prepared for limited storage must be given a limited technical inspection and processed as prescribed in SB 9-4. Results and classification will be entered on DA Form 461-5, Limited Technical Inspection.

### *b. Receiving Inspection.*

- (1) Report on DD Form 6, Receipt of Damaged or Improper Shipment, all vehicles received for storage in a damaged condition or improperly prepared for shipment, in accordance with SR 745-45-5. Report of vehicles received in an unsatisfactory condition (chronic failure or malfunction) will be made on DA Form 468, in accordance with SR 700-45-5.
2. When vehicles are inactivated, they will be processed in accordance with type I as prescribed in SB 9-4. Standby storage will ordinarily be handled by ordnance maintenance personnel only.
- (3) Immediately upon receipt of vehicles for storage, they must be inspected and serviced as prescribed in paragraphs 8 through 11. Perform a systematic inspection and replace or repair all missing or broken parts. If repairs are beyond scope of unit and vehicles will be inactivated for an appreciable length of time, place them in limited storage and attach

tags specifying the repairs needed. Report of these conditions will be submitted by the unit commander for action by an ordnance maintenance unit.

*c. Inspection During Storage.* Perform a visual inspection periodically to determine general condition. If corrosion is found, remove it and clean, paint, or treat with the prescribed preservatives.

*Note.* Touchup painting will be in accordance with TM 9-2851.

*d. Removal from Limited Storage.*

- (1) If vehicles are not shipped or issued upon expiration of the limited storage period, they will be further treated for standby storage by ordnance maintenance personnel.
- (2) If vehicles to be shipped will reach their destination within the limited storage period, they need not be reprocessed upon removal from storage unless inspection reveals it to be necessary according to anticipated intransit weather conditions.

*Note.* All vehicles being reissued through the depot supply system to troops within the continental limits of the United States must meet the requirements of TB ORD 385. This is NOT required for so-called reissues, exchanges, or redistribution among troop units, where the depot supply system is not involved.

- (3) Deprocess vehicles when it has been ascertained that they are to be placed into immediate service. Remove all corrosion-preventive compounds and lubricate as prescribed in paragraphs 69 through 74. Inspect and service vehicles as prescribed in paragraphs 8 through 11.
- (4) Repair and/or replace all items tagged in accordance with *b*(3) above.

*e. Storage Site.* Whenever possible, store vehicles under cover in open sheds or warehouses. When it is found necessary to store vehicles outdoors, the storage site must be selected in accordance with AR 700-105 and vehicles protected against the elements as prescribed in TB ORD 379.

## **285. Loading the 1/4-Ton 4 x 4 Utility Truck M38A1 and Ambulance M170 on Railroad Flatcar**

*a. Preparation.*

- (1) When vehicles are shipped by rail, every precaution must be taken to see that they are properly loaded and securely fastened and blocked to floor of flatcar.

*Note.* The spare tire for the ambulance M170 illustrated is located inside the vehicle. The spare tire for the utility truck M38A1, however, is attached to the rear of the vehicle. If these vehicles are to be lifted, rather than driven onto the flatcar, the attached spare tires may interfere with lifting devices, and they should be removed and secured with metal strapping at some other suitable location on the vehicle.

- (2) Prepare vehicles for rail shipment in accordance with SB 9-4. On-vehicle materiel will be thoroughly cleaned, preserved, packed (boxed or crated), and securely stowed in or on the vehicle as prescribed in *b* below.
  - (3) Load vehicles on flatcars so they will not form an unbalanced load.
  - (4) After each vehicle has been finally spotted on flatcar, apply parking brakes.
  - (5) Increase tire pressure slightly higher than normal except when vehicle is to be shipped to hot weather areas.
- b. On-Vehicle Materiel (OVM) Requirements.*
- (1) *General.* Preserve and package all OVM individually, except items used in sets or in quantities greater than one.
  - (2) *Battery and electrolyte.*
    - (a) If the materiel is to be shipped within the continental limits of the United States, *except* directly to ports of embarkation, disconnect the battery cables from battery, clean ((*b*) below), if necessary, coat cable terminals and battery posts with automotive and artillery grease (GAA), and wrap with nonhygroscopic adhesive tape. Secure terminals *away* from battery.
    - (b) If materiel is to be shipped directly to ports of embarkation, *except*, when it is to be combat-loaded, disconnect battery cables and remove batteries. Plug vents and clean outside of batteries with a solution containing one-half pound of commercial grade baking soda (sodium carbonate) to one gallon of water. Rinse with *cool* water and remove vent plugs. Scrape or wire-brush and clean cable terminals and battery box (holder) with this cleaning solution, rinse with *cool* water, coat terminals with automotive and artillery grease (GAA) and wrap with nonhygroscopic adhesive tape. Paint battery boxes, if required, with black acid-resisting paint. Battery and electrolyte will be packed in accordance with TM 9-2857 and shipped in vehicle separate from other OVM.
  - (3) *Publications.* Place technical manual in type 1, grade A, class B bags and heat seal the opening (Method IC-3, TM 9-1005). Pack in the OVM container. Publications provided by separate technical services will be packaged similarly and packed in the same exterior OVM containers as the items to which they are applicable.
  - (4) *Unit packages.* Unit packages that are not water-resistant and are impracticable for intermediate packaging will be overwrapped in flexible waterproof barrier-material (method IC-2, TM 9-1005) and sealed with waterproof, water-resistant adhesive.

- (5) *Intermediate packages.* Whenever possible, unit packages of related items will be grouped together, into intermediate packages in fiberboard cartons. Container closure will be made by sealing all seams with water-resistant, gummed paper tape. When the gross weight exceeds 20 pounds, the container will be sealed with water-resistant adhesive (for sealing fiberboard boxes), in addition to being sealed with tape (TM 9-1005).
- (6) *Exterior containers.*
- (a) Keep the number of exterior containers to a minimum. The size will be governed by the cubic displacement of the packaged OVM. Dimensions will be such that, when assembled in sets as required and stowed on vehicles, the overall cubage of the vehicles will not be increased and lifting devices will not be obstructed.
  - (b) Place heavy materiel or equipment in the bottom of exterior containers and block and brace, as necessary, so they will not damage other contents. Pack fragile materiel and canvas items above other OVM items, at the top of the containers; in addition, pack canvas covers for OVM items in the same exterior containers with the items for which they are intended.
  - (c) Pack unit and intermediate packages in style 2, unlined, snug-fitting, nailed wood boxes, for a type III load (see TM 9-1005), modified as prescribed in 1 through 5 below.
    1. Exterior containers over 200 pounds gross weight will have nominal 2 x 4 end cleats. Also, beveled end skids of nominal 2 x 4 lumber will be placed flat, parallel to the ends of the containers, and spaced approximately 6 inches from each end, with span between skids not to exceed 36 inches.
    2. The skids will be fastened to the bottom with nails driven through the floor into the skids. Nails will be of sufficient length and size to achieve maximum holding power.
    3. Additional battens, when required, will be fastened to the inside faces of the top and side panels; additional battens will be fastened to the inside face of the bottom panel, when skids are not required.
    4. Construct the container top of matched lumber and nail to the side and end panels. The container will be weather-proofed, strapped, and marked in accordance with TM 9-1005.

*Note.* Weatherproofing of container tops will not be necessary, if containers are to be stowed within the vehicle (if the vehicle is covered).

5. Cover exterior surfaces of all OVM exterior containers (except tops) with one coat of quick-drying lustreless enamel.

*Note.* OVM containers stowed within the vehicle will not require painting if the vehicle is covered.

(7) *Stowage.*

- (a) Stow all OVM containers inside the body of vehicle, when practical. Containers stowed outside the vehicle must be placed so as not to increase the cubic displacement of the vehicle. Strap, block, or brace all OVM containers to prevent free movement.

*Note.* OVM containers must receive maximum protection against corrosion, deterioration, and mechanical damage during shipment and prolonged periods of storage.

- (b) OVM containers constructed without skids, which are to be stowed in exposed locations in contact with platforms, floors, or other boxes, will be placed on nominal 1 x 4 wood cleats to minimize surface contact. Secure cleats in a manner that will prevent shifting or damage to contact surfaces.
- (c) If vehicle is equipped with steel tool boxes, remove all padlocks and keys from vehicle in order to prevent pilferage while in transit. Secure lids of steel tool boxes by wiring hasp to prevent damage during shipment. Preserve padlocks and keys with preservative engine oil (grade 1) and wrap in greaseproof barrier material for domestic shipment or seal in a waterproof-greaseproof wrapping or bag (Method IC-1) for oversea shipment. Locate all wrapped padlocks and keys in shipping container with parts.

*c. Method of Loading the 1/4-ton 4 x 4 Ambulance M170 and Utility Truck M38A1 on Flatcars.* For method of loading and general loading rules pertaining to rail shipment of ordnance vehicles, see TB 9-OSSC-G.

**Warning:** The height and width of vehicles, when prepared for rail transportation, must not exceed the limitations indicated by the loading table in AR 700-105 (section II). Whenever possible, local transportation officers must be consulted about the limitations of the particular railroad lines to be used for the movement in order to avoid delays, dangerous conditions, or damage to equipment.

## **286. Blocking the 1/4-Ton 4 x 4 Ambulance M170 for Rail Shipment**

*a. General.* All blocking instructions specified herein are minimum and are in accordance with Pamphlet No. MD-7, Rules Governing the Loading of Defense Materiel on Open Top Cars of the Association

of American Railroads. Additional blocking may be added, as required, at the discretion of the officer in charge. Double-headed nails may be used, except in the lower piece of two piece cleats. All item reference letters in *b* through *e* (5) below refer to details and locations shown in figures 203 and 204. The number of vehicles to be loaded will depend upon the length of flatcar.

*Note.* Any other loading methods or instructions, regardless of source, which appear to be in conflict with this publication or existing loading rules of the carriers, must be submitted for approval to the Chief of Ordnance, Department of the Army, Washington 25, D. C.

*b. Brake Wheel Clearance "A."* Load vehicles on flatcars, with a minimum clearance of at least 4 inches below and 6 inches above, behind, and to each side of the brake wheel. Any increase in clearance must be consistent with proper location of load.

*Note.* Three methods of blocking are given herein; the method to be used will depend on dimensions of flatcars and availability of required blocking materials. These instructions are for vehicles double-loaded as shown in figure 203. Vehicles may also be single-loaded. Double-deck loading, or incline-loading (with the front wheels of the second vehicle positioned in the rear body of the first vehicle, etc.) will be restricted to vehicles shipped unroofed.

*c. Method I.*

- (1) *Chock blocks "B"* (6 x 9 x 12, six required per truck, constructed as shown in detail 1, fig. 204). Locate the 53 degree surface of blocks against the front and rear of each outside wheel, against the front of each inside front wheel, and against the rear of each inside rear wheel. Nail heel of each block to car floor with three forty penny nails and toenail both sides of blocks to car floor with one forty penny nail each.

*Note.* Alternate type B-1 or B-2 chock blocks may be constructed as shown in details 2 and 3, figure 204 and located against tires as shown in details 1 and 2, figure 203. Vehicles, single-loaded, require chock blocks at the front and rear of all four wheels.

- (2) *Inside wheel blocks "C"* (6 x 9 x 12, four required per truck, constructed as shown in detail 1, figure 204). Locate the 6 x 9 surface of block flush against the inside of each wheel, as shown in figure 203. Nail heel of each block to car floor with forty penny nails and toenail each side to floor with one forty penny nail.

*Note.* Alternate type inside wheel blocks C-1 may be constructed as shown in detail 4, figure 204, and located against tires as shown in detail 2, figure 203. When inside wheel blocks C-1 are used, cushioning material "D" (waterproof paper or burlap) will be placed between blocks C-1 and inside of tire. The material should extend 2 inches beyond block on car floor and 2 inches above block against side of tire.

- (3) *Vehicle strapping "E"* (1-in. No. 14 BW gage, hot-rolled steel, length to suit, two required per truck). Locate



"A"  
BRAKE WHEEL  
CLEARANCE

NOTES:

- 1—THE 1/4-TON 4X4 AMBULANCES M170 SHOWN HAVE NOT BEEN PROCESSED FOR DOMESTIC FREIGHT SHIPMENT BUT SIMPLY ILLUSTRATE METHOD OF BLOCKING. THE 1/4-TON 4X4 UTILITY TRUCKS M38A1 WILL BE BLOCKED THE SAME AS THESE AMBULANCES.
- 2—REFERENCE LETTERS PERTAIN TO DESCRIPTIONS IN TEXT.
- 3—THE HEIGHT AND WIDTH OF THESE AMBULANCES, WHEN PREPARED FOR RAIL TRANSPORTATION, MUST NOT EXCEED THE LIMITATIONS INDICATED BY THE LOADING TABLE IN AR 700-105 (SECTION II). WHENEVER POSSIBLE, LOCAL TRANSPORTATION OFFICERS MUST BE CONSULTED ABOUT THE LIMITATIONS OF THE PARTICULAR RAILROAD LINES TO BE USED FOR THE MOVEMENT IN ORDER TO AVOID DELAYS, DANGEROUS CONDITIONS, OR DAMAGE TO EQUIPMENT.

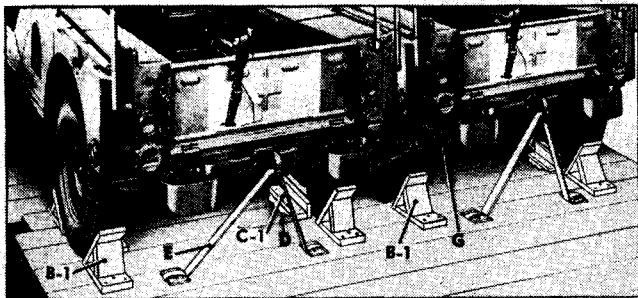

**DETAIL 1**  
**ALTERNATE METHOD OF BLOCKING WHEELS**

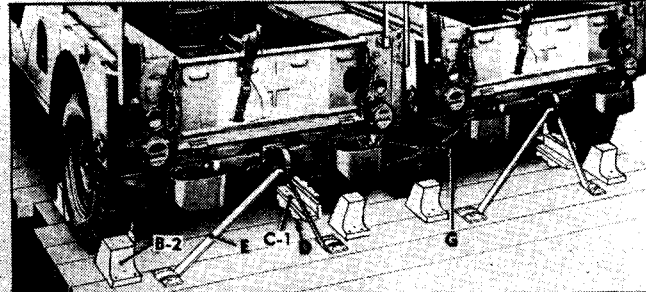

**DETAIL 2**  
**ALTERNATE METHOD OF BLOCKING WHEELS**

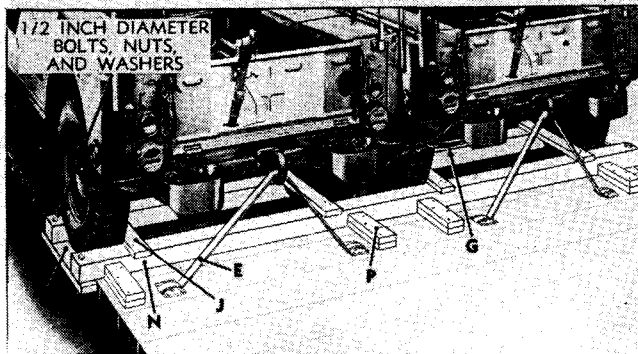

**DETAIL 3**  
**ALTERNATE METHOD OF BLOCKING WHEELS ON NARROW FLATCARS**

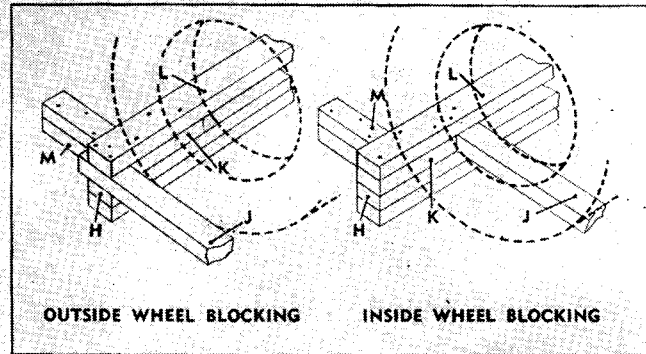

**DETAIL 4**  
**ALTERNATE METHOD OF BLOCKING WHEELS**

RA PD 212123

Figure 203. Methods of blocking the 1/4-ton 4 x 4 ambulance M170 on flatcars.



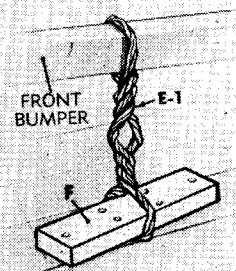
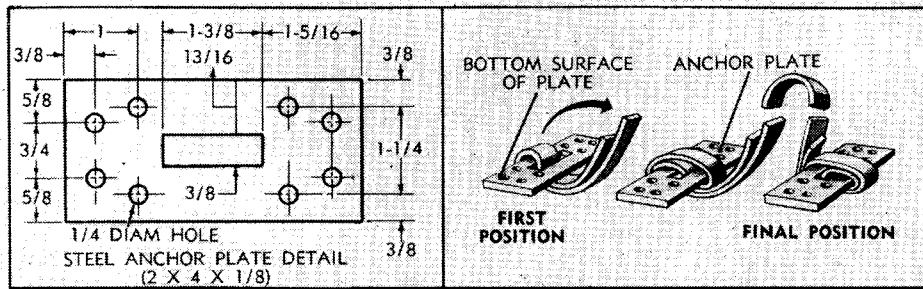
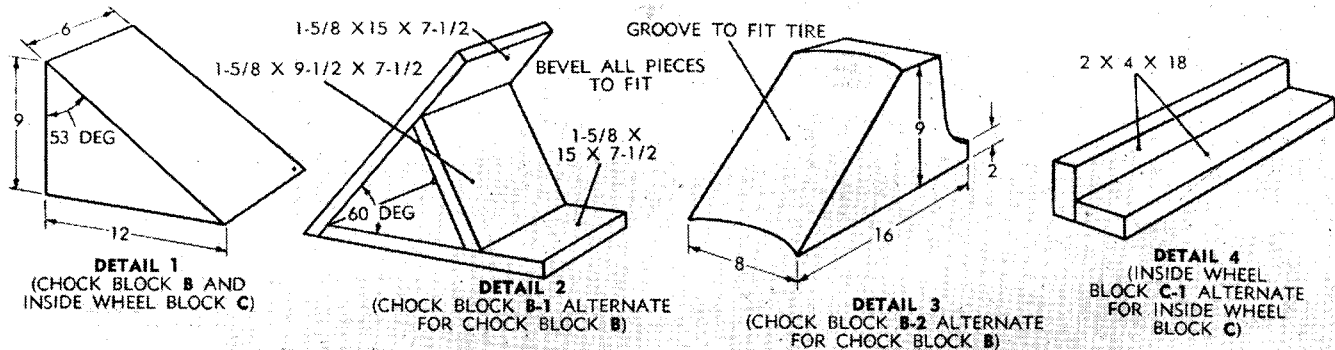

NOTES: 1-ITEM REFERENCE LETTERS PERTAIN TO DESCRIPTIONS IN TEXT  
2-ALL DIMENSIONS SHOWN ARE IN INCHES

RA PD 212045

Figure 204. Materials for blocking the 1/4-ton 4 x 4 ambulance M170 on flatcars.

strapping "E" over front bumper of vehicle and through rear pulling hook of vehicle, as shown in figure 203. Pass strapping "E" over front bumper of vehicle and through and nail anchor plates to car floor with eight twentypenny nails. Substitute, if desired, four strands of No. 8 gage, black annealed wire, "E-1," twist-tied to form cables. Pass the cable over the bumper or through the pulling hook underneath and around random 2 x 4 x 18 cleat "F" (detail 6, figure 204). Nail cleat lengthwise to car floor and twist-tighten cables to remove all slack.

- (4) *Vehicle ties "G"* (6 strands, 3 wrappings, No. 8 gage, black annealed wire, length to suit). Pass cables around frame (bumpers, hooks, brackets, etc.) at front and rear of every two side-by-side vehicles as shown in figure 203. Twist-tighten cables to remove all slack.

d. *Method II.*

- (1) *Wheel cleats "N"* (4 in. wide, 6 in. high, 8 inches longer than width of car, four required for every two side-by-side trucks). Locate a cleat "N" across the front and rear of front and rear wheels as shown in detail 3, figure 203, and toenail each to car floor with four thirtypenny nails.
- (2) *Wheel supports "Q"* (2 x 4 in., 2 inches longer than distance between outside faces of cleats "N" two required per truck). Locate the 2-inch side of support "Q" against each side of car floor. Secure each end to cleats "N" with 1-inch diameter bolt, nut, and washer, as shown in detail 3, figure 203.

*Note.* After the nuts have been assembled to the bolts, nick the threaded portion of each bolt behind the nut to prevent the nut from turning loose.

- (3) *Wheel cleats "J"* (2 x 4 in. 4 inches longer than distance between outside faces of cleats "N," four required per truck). Locate cleat "J" across top cleats "N" with sides of cleats "J" flush against inside of tires, as shown in detail 3, figure 203. Nail end of each cleat "J" to cleats "N" with three twentypenny nails.
- (4) *Support cleats "P"* (2 x 4 x 18 in., eight required per truck). Locate four cleats "P" equidistant across car floor with ends flush against cleats "N," as shown in detail 3, figure 203. Nail cleat to car floor with four thirtypenny nails. Locate one cleat on top of each lower cleat and nail with four thirtypenny nails.

e. *Method III.*

- (1) *Wheel cleats "H"* (2 x 4 in., length to suit, eight required for every two side-by-side vehicles). Locate a cleat "H" across flatcar close to front and rear of front and rear wheels and

nail to car floor with ten thirtypenny nails; locate an upper cleat on each lower cleat and nail with ten thirtypenny nails as shown in detail 4, figure 203.

- (2) *Wheel side cleats "J"* ( $2 \times 4$  in., length  $\frac{1}{4}$  inches longer than distance between outer face of cleats "H," four required per vehicle). Locate a cleat "J" against inside or outside of wheels as shown in detail 4, figure 203, and nail each end to cleats "H" with three twentypenny nails.
- (3) *Intermediate cleats "K"* ( $2 \times 4$  in., eight required per vehicle). Locate a cleat "K" on top of cleats "H" with end flush against cleat "J" and nail to cleats "H" with two twentypenny nails as shown in detail 4, figure 203.

*Note.* If flatcar is too narrow, cleats "J" will be placed on the inside of wheels and cleats "K" will be on the outside of cleats "J." If flatcars are wide enough, cleats "J" will be on the outside of wheels and cleats "K" will be on the inside of cleats "J."

- (4) *Upper cleats "L"* ( $2 \times 4$  in., length to equal cleats "H," four required per truck). Locate a cleat "L" across cleats "J" and nail to cleats "J" and "K" with three twentypenny nails at each end as shown in detail 4, figure 203.
- (5) *End cleats "M"* ( $2 \times 4 \times 18$  in., total of eight required). Locate a cleat "M" on car floor at each end of load, with end flush against cleat "H," near each side of car, and secure with four thirtypenny nails. Locate one cleat "M" on top of each lower cleat and secure with four thirtypenny nails as shown in detail 4, figure 203.

## 287. Marking

a. Identification marking will be stamped on metal tags after which tags will be dipped in ordnance yellow paint, and securely attached with soft wire on the front and rear of each vehicle. Marking will consist of nomenclature, stock number, gross weight, cubage, shipping dimensions, names of contractor, and contract number.

b. Processing directive (identifying number), symbol of installation performing processing, and date processed, will be stenciled with gasoline-soluble, white or yellow paint on the inside surfaces of the windshield and rear window on the side opposite to the driver.

c. The complete coded oversea address (where applicable) will be stenciled in an unobstructed location (front and rear) with gasoline-soluble paint (white or yellow on OD surfaces). The stenciling will be in letters not more than  $1\frac{1}{2}$  inches nor less than  $\frac{3}{4}$  inches high. An equilateral triangle (ordnance yellow) not more than 3 inches nor less than  $1\frac{1}{2}$  inches high will be stenciled on each vehicle adjacent to the oversea address.

## Section II. DESTRUCTION OF MATERIEL TO PREVENT ENEMY USE

### 288. General

*a.* Destruction of the  $\frac{1}{4}$ -ton 4 x 4 utility truck M38A1 and the  $\frac{1}{4}$ -ton 4 x 4 front line ambulance M170 when subject to capture or abandonment in the combat zone will be undertaken by the using organization only when, in the judgment of the unit commander concerned, such action is necessary in accordance with orders of, or policy established by, the army commander.

*b.* The information which follows is for guidance only. Certain of the procedures outlined require the use of explosives and incendiary grenades which normally may not be authorized items for the vehicle. The issue of these and related materials, and the conditions under which destruction will be effected, are command decisions in each case, according to the tactical situation. Of the several means of destruction, those most generally applicable are—

Mechanical—Requires axe, pick mattock, sledge, crowbar, or similar implement.

Burning — Requires gasoline, oil, incendiary grenades, or other flammables.

Demolition—Requires suitable explosives or ammunition.

Gunfire— Includes artillery, machine guns, rifles using rifle grenades, and launchers using antitank rockets. Under some circumstances hand grenades may be used.

In general, destruction of essential parts, followed by burning will usually be sufficient to render the vehicle useless. However, selection of the particular method of destruction requires imagination and resourcefulness in the utilization of the facilities at hand under the existing conditions. Time is usually critical.

*c.* If destruction to prevent enemy use is resorted to, the vehicle must be so badly damaged that it cannot be restored to a usable condition in the combat zone either by repair or cannibalization. Adequate destruction requires that all parts essential to the operation of the materiel, including essential spare parts, be destroyed or damaged beyond repair. However, when lack of time and personnel prevents destruction of all parts, priority is given to the destruction of those parts most difficult to replace. Equally important, the same essential parts must be destroyed on all like materiel so the enemy cannot construct one complete unit from several damaged ones.

*d.* If destruction is directed, due consideration should be given to—

- (1) Selection of a point of destruction that will cause greatest obstruction to enemy movement and also prevent hazard to

friendly troops from fragments or ricocheting projectiles which may occur incidental to the destruction.

- (2) Observance of appropriate safety precautions.

## 289. Destruction of the ¼-Ton 4 x 4 Vehicle

The vehicles covered in this manual are similar with the exception of differences in chassis length and the bodies mounted thereon. Therefore, the methods of destruction described in paragraphs 290, 291, and 292 are applicable to both vehicles.

### 290. Method No. 1—Destruction by Burning

*a.* Using an axe, pick mattock, sledge, or other heavy implement, smash all vital elements such as distributor, carburetor, generator, ignition coil, fuel pump, spark plugs, air cleaner, lights, instruments, and controls. If time permits, and a sufficiently heavy implement is available, smash the engine cylinder block and head, crankcase, and transmission.

*b.* Puncture fuel tank as near the bottom as possible, collecting gasoline for use as outlined in *e* below.

*c.* Slash tires. If tires are inflated exercise care to prevent injury should the tire blow out while being slashed. Whenever practicable, it is usually preferable to deflate tires before slashing.

*d.* Explosive ammunition, if available nearby, should be removed from packing or other protective material. Place ammunition in and about the vehicle so that it will be fully exposed to the fire and in such locations that the greatest damage will result from its detonation. Remove any safety devices from ammunition.

*e.* Pour gasoline and oil in and over the entire vehicle. Ignite by means of an incendiary grenade fired from a safe distance, a burst from a flame thrower, a combustible train of suitable length, or other appropriate means. Take cover immediately. If gasoline and oil are not available, use other flammables such as oily rags or waste, wood, or paper. Ignite by means of incendiary grenades or other suitable means.

**Caution:** Cover must be taken without delay since an early explosion of the explosive ammunition, if present, may be caused by the fire. Due consideration should be given to the highly flammable nature of gasoline and its vapor. Carelessness in its use may result in painful burns. Elapsed time: about 6 minutes.

### 291. Method No. 2—Destruction by Demolition

*a.* Prepare two 2-pound charges of EXPLOSIVE, TNT (two 1-lb blocks or equivalent per charge together with the necessary detonating cord to make up each charge). Set the charges as follows:

- (1) The *first*, on *top* of the clutch housing.

- (2) The *second*, as low on the *left* side of the engine as possible.
- (3) Connect the *two* charges for simultaneous detonation with detonating cord. Provide for dual priming to minimize the possibility of a misfire.
- (4) For priming either a nonelectric blasting cap crimped to at least 5 feet of safety fuse (safety fuse burns at the rate of 1 ft in a prx 40 sec; test before using) or an electric blasting cap and firing wire may be used. Safety fuse, which contains black powder, and nonelectric blasting caps must be protected from moisture at all times. The safety fuse may be ignited by a fuse lighter or a match; the electric blasting cap requires a blasting machine or equivalent source of electricity.

**Caution:** Keep the blasting caps, detonating cord, and safety fuse separated from the charges until required for use.

*Note.* For the successful execution of methods of destruction involving the use of demolition materials, all personnel concerned will be thoroughly familiar with the pertinent provisions of FM 5-25. Training and careful planning are essential.

*b.* Destroy the tires as in paragraph 290*c*.

*c.* Detonate the charges. If primed with nonelectric blasting cap and safety fuse, ignite and take cover. If primed with electric blasting cap, take cover before firing the charges. The danger zone is approximately 200 yards. Elapsed time: about 5 minutes.

## **292. Method No. 3—Destruction by Gunfire**

*a.* Destroy the tires as in paragraph 290*c*.

*b.* Destroy the vehicle by gunfire using artillery, machine guns, rifles using rifle grenades, or launchers using antitank rockets. Fire on the vehicle aiming at the engine, axles, body, and wheels. Although one well-placed direct hit may destroy the vehicle, several hits are usually required for complete destruction unless an intense fire is started, in which case the vehicle may be considered destroyed.

**Caution:** Firing artillery at ranges of 500 yards or less should be from cover. Firing rifle grenades or antitank rockets should be from cover. Elapsed time: about 5 minutes.

## APPENDIX

### REFERENCES

---

#### 1. Publication Indexes

Special Regulations in the 310-20-series, DA Pam 108-1, DA Pams in the 310-series, and FM 21-8 should be consulted frequently for latest changes or revisions of references given in this appendix and for new publications relating to materiel covered in this manual.

#### 2. Supply Manuals

The following manuals of the Department of the Army Supply Manual pertain to this materiel:

*a. Destruction to Prevent Enemy Use.*

Land Mines and Components; Demolition Explosives and Related Items; and Ammunition for Simulated Artillery, Booby Trap, Hand Grenade, and Land Mine Fire. ORD 3 SNL R-7

*b. Maintenance and Repair.*

Cleaners, Preservatives, Lubricants, Recoil Fluids, Special Oils, and Related Maintenance Materials. ORD 3 SNL K-1

Items of Soldering, Metallizing, Brazing and Welding Materials: Gases and Related Items. ORD 3 SNL K-2

Lubricating Equipment, Accessories, and Related Dispensers. ORD (\*) SNL K-3

Lubricating Fittings, Oil Filters, and Oil Filter Elements. ORD 5 SNL H-16

*c. Vehicle.*

Truck, Ambulance, Front Line, ¼-Ton, 4 x 4, M170, and Truck, Utility, ¼-Ton, 4 x 4, M38A1.

Field and Depot Maintenance Allowances..... ORD 8, SNL G-758

Organizational Maintenance Allowances..... ORD 7, SNL G-758

Truck, Utility, ¼-Ton, 4 x 4, M38A1; List of All Service Parts. ORD 9, SNL G-758

*d. General.*

Introduction ..... ORD 1

\*See DA Pamphlet 310-29, Index of Supply Manuals—Ordnance Crops, for published types of manuals of the Ordnance section of the Department of the Army Supply Manual.

### 3. Forms

The following forms pertain to this materiel :

- Standard Form 91, Operator's Report of Motor Vehicle Accident.
- Standard Form 93, Report of Investigating Officer.
- Standard Form 94, Statement of Witness.
- DA Form 9-3, Processing Record for Storage and Shipment of Vehicles and Boxed Engines.
- DA Form 9-4, Vehicular Storage and Servicing Record.
- DA Form 9-68, Spot Check Inspection Report for Wheeled and Half-Track Vehicles.
- DA Form 9-75, Daily Dispatching Record of Motor Vehicles.
- DA Form 285, Accident.
- DA Form 348, Driver Qualification Record.
- DA Form 460, Preventive Maintenance Roster.
- DA Form 461, Preventive Maintenance Service and Inspection for Wheeled and Half-Track Vehicles.
- DA Form 461-5, Limited Technical Inspection.
- DA Form 468, Unsatisfactory Equipment Report.
- DA Form 478, Organizational Equipment File.
- DA Form 811, Work Request and Job Order.
- DA Form 811-1, Work Request and Hand Receipt.
- DA Form 1089, Claim for Personal Property.
- DD Form 6, Report of Damaged or Improper Shipment.
- DD Form 313, U. S. Government Operator's Permit.
- DD Form 317, Preventive Maintenance Service.

### 4. Other Publications

The following explanatory publications contain information pertinent to this materiel and associated equipment :

#### *a. Camouflage.*

- Camouflage, Basic Principles..... FM 5-20
- Camouflage of Vehicles..... FM 5-20B

#### *b. Decontamination.*

- Decontamination..... TM 3-220
- Defense Against CBR Attack..... FM 21-40

#### *c. Destruction to Prevent Enemy Use.*

- Explosives and Demolitions..... FM 5-25

#### *d. General.*

- Cleaning and Black Finishing Equipment of Ferrous Metals..... TM 9-1861
- Cooling Systems: Vehicles and Powered Ground Equipment..... TM 9-2858
- Driver's Manual..... TM 21-305
- Driver Selection and Training..... TM 21-300
- Fording Kits for Combat and Transport Vehicles..... MIL-F-3201
- Fuel-Burning Heaters for Winterization Equipment..... TM 9-8662
- Inspection of Ordnance Materiel in the Hands of Troops..... TM 9-1100
- Instruction Guide: Operation and Maintenance of Ordnance Materiel in Extreme Cold (0° to -65° F.). TM 9-2855
- Military Vehicles..... TM 9-2800



Motor Transportation Operations.....	FM 25-10
Mountain Operations.....	FM 70-10
Operations in the Arctic.....	FM 31-71
Precautions in Handling Gasoline.....	AR 850-20
Preparation of Ordnance Materiel for Deep Water Fording.....	TM 9-2853
Principles of Automotive Vehicles.....	TM 9-2700 (to be re- numbered TM 9-8000- 1)
Prevention of Motor Vehicle Accidents.....	AR 385-55
Accident Reporting.....	SR 385-10-40
Spark Plugs.....	TB ORD 313
Storage Batteries, Lead-Acid Type.....	TM 9-2857
Supplies and Equipment: Motor Vehicles.....	AR 700-105
Supplies and Equipment: Unsatisfactory Equipment Report.....	SR 700-45-5

*e. Maintenance and Repair.*

Abrasive, Cleaning, Preserving, Sealing, Adhesive, and Related Materials Issued for Ordnance Materiel.	TM 9-850
Instruction Guide: Care and Maintenance of Ball and Roller Bearings.	TM 37-265
Lubrication.....	TM 9-2835
Maintenance and Care of Hand Tools.....	TM 9-867
Maintenance and Care of Pneumatic Tires and Rubber Treads.....	TM 31-200
Maintenance of Supplies and Equipment: Maintenance Responsibilities and Shop Operation.	AR 750-5
Painting Instructions for Field Use.....	TM 9-2851
Preparation of Ordnance Materiel for Deep Water Fording.....	TM 9-2853
Tactical Motor Vehicle Inspection and Preventive Maintenance Services.	TM 9-2810

*f. Shipment and Limited Storage.*

Army Shipping Document.....	TM 38-705
Instruction Guide: Ordnance Preservation, Packaging, Packing, Storage and Shipment.	TM 9-1005
Manual of Approved Packaging Instructions for Major Items and Spare Parts for Ordnance General Supplies.	PS 1000 <sup>1</sup>
Marking of Arctic-Lubricated Materiel and Equipment.....	SR 746-30-10
Marking of Oversea Supply.....	SR 746-30-5
Shipment Digit Marking.....	SR 746-30-6
Military Standard, Marking of Shipments.....	MIL STD 129 <sup>2</sup>
Ordnance Storage and Shipment Chart—Group G.....	TB 9-OSSC-G
Packaging and Packing for Shipment and Storage of Spare Parts for Military Vehicles.	MIL-P-11443 (ORD)
Packaging of On Vehicle Materiel (OVM) for Military Vehicles, Transport and Combat.	MIL-P-12841 (ORD)
Preparation of Supplies and Equipment: Processing of Unboxed and Uncrated Equipment for Oversea Shipment.	AR 747-30
Preservation, Methods of.....	MIL-P-116B

<sup>1</sup> Copies may be obtained from the Raritan Arsenal Publications Division, Metuchen, N. J.

<sup>2</sup> Copies may be obtained from Aberdeen Proving Ground, Aberdeen, Md.

Preservation, Packaging, and Packing of Military Supplies and Equipment.	TM 38-230
Preservation, Packaging, and Packing Materials, Supplies and Equipment Used in the Army.	SB 38-100
Processing of Motor Vehicles and Related Unboxed Materiel for Shipment and Storage.	SB 9-4
Protection of Ordnance General Supplies in Open Storage-----	TB ORD 379
Shipment of Supplies and Equipment: Report of Damaged or Improper Shipment.	SR 745-45-5
Standards for Oversea Shipment and Domestic Issue of Ordnance Materiel other than Ammunition and Army Aircraft.	TB ORD 385

## INDEX

	<i>Para- graphs</i>	<i>Page</i>
Absorbers, shock:		
Data (M38A1).....	239	290
Data (M170).....	240	291
Description (M38A1).....	239	290
Description (M170).....	240	291
Installation.....	247	299
Organizational maintenance.....	241	291
Removal.....	247	299
Troubleshooting.....	101	97
Accelerator pedal. ( <i>See</i> Pedal, accelerator.)		
Accidents, report of.....	3	4
Adjustment:		
Accelerator pedal.....	135	147
Breaker point set.....	151	173
Carburetor.....	134	144
Choke control.....	135	147
Clutch linkage.....	191	231
Fan and generator drive belt set.....	130	140
Front hub bearings.....	208	249
Handbrake.....	238	287
Headlights.....	163	201
Rear view mirror.....	259	316
Service brakes.....	233	276
Steering gear.....	230	271
Throttle control.....	135	147
Toe-in.....	224	296
Valve clearance.....	110	109
Air cleaner, assy:		
Installation.....	136	153
Removal.....	136	153
Ammeter (M38A1):		
Installation.....	174	219
Removal.....	174	219
Axle, front ( <i>see also</i> Shafts, front axle with universal joints):		
Data.....	206	245
Description.....	4, 206	5, 245
Installation.....	214	258
Removal.....	214	258
Troubleshooting.....	96	94
Axle, rear ( <i>See also</i> Shafts, rear axle):		
Data.....	215	259
Description.....	4, 215	5, 259
Installation.....	221	263
Removal.....	221	263
Troubleshooting.....	97	95

	<i>Para-</i> <i>graphs</i>	<i>Page</i>
Bar, stabilizer. (See Stabilizer bar (M170).)		
Batteries:		
Installation.....	162	197
Maintenance after fording.....	276	349
Removal.....	162	197
Batteries and lighting system:		
Data.....	161	194
Description.....	161	194
Troubleshooting.....	87	87
Battery cables. (See Cables, battery.)		
Battery generator indicator (M170). (See Indicator, battery generator (M170).)		
Bearings, front hub:		
Adjustment.....	208	249
Cleaning and packing.....	208	249
Installation.....	208	249
Removal.....	208	249
Bearings, rear axle shaft.....	217	262
Bearings, steering knuckle flange:		
Cleaning and packing.....	213	253
Installation.....	213	253
Removal.....	213	253
Bellcrank, steering:		
Installation.....	228	270
Removal.....	228	270
Bell set, fan and generator drive:		
Adjustment.....	130	140
Installation.....	130	140
Removal.....	130	140
Blackout driving lights:		
Installation.....	164	205
Lamp unit with cables assy:		
Installation.....	164	205
Removal.....	164	205
Removal.....	164	205
Bleeding brake system. (See Brake system.)		
Body (M170):		
Date.....	262	329
Description.....	262	329
Maintenance after fording.....	276	349
Body (M38A1):		
Data.....	253	304
Description.....	253	304
Maintenance after fording.....	276	349
Bolts, spring pivot:		
Installation.....	244	296
Removal.....	244	296
Bond straps (See Regulator, generator)		
Bows, side and center top (M170):		
Installation.....	268	335
Removal.....	268	335
Brake drums. (See Drums, brake.)		
Brake, hand:		
Adjustment.....	238	282

	<i>Para-</i> <i>graphs</i>	<i>Page</i>
<b>Brake, hand—Continued</b>		
Shoe with lining:		
Installation.....	238	287
Removal.....	238	287
Troubleshooting.....	99	97
<b>Brake line. (See Brake system).</b>		
<b>Brake pedal. (See Pedal, service brake.)</b>		
<b>Brake, service:</b>		
Adjustment.....	233	276
Shoe with lining:		
Installation.....	233	276
Removal.....	233	276
Troubleshooting.....	98	95
<b>Brake system:</b>		
Bleeding.....	237	287
Data.....	231	275
Description.....	4, 231	5, 275
Lines and connections.....	236	283
Maintenance after fording.....	276	349
Organizational maintenance.....	10	21
<b>Break-in.....</b>	10	21
<b>Breaker point capacitor. (See Distributor.)</b>		
<b>Breaker points. (See Distributor).</b>		
<b>Bumper bar:</b>		
<b>M38A1:</b>		
Installation.....	260	322
Removal.....	260	322
<b>M170.....</b>	271	343
<b>Bumperettes:</b>		
<b>M38A1:</b>		
Installation.....	260	322
Removal.....	260	322
<b>M170.....</b>	271	343
<b>Cables, battery:</b>		
Removal.....	162	197
Installation.....	162	197
<b>Cap, horn button. (See Steering wheel.)</b>		
<b>Cap, steering knuckle flange. (See Steering knuckle flange cap.)</b>		
<b>Carburetor:</b>		
Adjustment.....	134	144
Installation.....	134	144
Removal.....	134	144
Throttle valve body-to-manifold insulator:		
Installation.....	134	144
Removal.....	134	144
<b>Caution:</b>		
Battery.....	162	197
Bearings.....	70	59
Carburetor.....	134	144
Clutch pedal.....	44	35
Extreme-cold.....	60	51
Front axle shafts installation.....	207	245
Fuel tank (M170) installation.....	141	159
Gearshift lever.....	46	36

	<i>Para-</i> <i>graphs</i>	<i>Page</i>
Caution—Continued		
Generator.....	158	184
Generator regulator (M38A1).....	159	190
Generator regulator (M170).....	160	192
Hand brake adjustment.....	238	287
Oil pressure gage.....	90	90
Organizational maintenance, cooling system.....	127	136
Power plant.....	120, 124	123, 132
Removal of accumulations after operation.....	63	54
Reverse gear.....	49	38
Service brakes.....	98	95
Starter.....	42	33
Steering gear removal.....	230	271
Table II, tags.....	78	71
Table II, water and oil pressure.....	78	71
Table III, leaks.....	79	73
Towing.....	52	39
Troubleshooting.....	80	79
Unusual conditions.....	59	50
Choke control. (See Control, choke.)		
Circuit identification.....	171	212
Clutch:		
Data.....	190	230
Description.....	190	230
Linkage adjustment.....	191	231
Troubleshooting.....	92	92
Coil, ignition:		
Installation.....	152	178
Removal.....	152	178
Common tools and equipment.....	67	57
Compartment, medical supplies stowage:		
General.....	57	48
Opening and closing.....	57	48
Control, carburetor.....	135	147
Control, choke:		
Adjustment.....	135	147
Installation.....	135	147
Removal.....	135	147
Control, throttle:		
Adjustment.....	135	147
Installation.....	135	147
Removal.....	135	147
Controls and instruments:		
Accelerator pedal.....	16	24
Ammeter (M38A1) and battery generator indicator (M170).....	33	31
Choke control.....	22	27
Clutch pedal.....	15	23
Emergency reel lamp switch.....	40	33
Fuel level gage.....	34	31
General.....	12	22
Glove compartment door lock.....	27	30
Handbrake handle.....	20	27
Headlight dimmer switch (M170).....	25	29
Headlight high beam indicator light.....	38	32

	<i>Para-</i> <i>graphs</i>	<i>Page</i>
<b>Controls and instruments—Continued</b>		
Horn button cap .....	32	31
Ignition switch .....	23	27
Instrument panel lights .....	37	32
Light switch .....	24	28
Medical supplies stowage compartment handles (M170) ..	29	30
Oil pressure gage .....	35	31
Service brake pedal .....	14	22
Speedometer .....	39	32
Starter pedal .....	17	25
Steering wheel .....	13	22
Throttle control .....	21	27
Tool compartment lid handle .....	28	30
Transfer levers .....	19	26
Transmission gearshift lever .....	18	25
Water temperature gage .....	36	32
Windshield locks .....	26	30
Windshield wiper air regulating valve .....	30	30
Windshield wiper manual control handles .....	31	31
<b>Cooling system:</b>		
Data .....	126	136
Description .....	126	136
Organizational maintenance .....	127	136
Troubleshooting .....	88	88
<b>Coordination with ordnance maintenance unit. (See Organi-</b> <b>zational maintenance allocation.)</b>		
Correction of deficiencies .....	11	22
<b>Cover, rocker arm:</b>		
Installation .....	108	105
Removal .....	108	105
<b>Cover, valve compartment:</b>		
Installation .....	109	107
Removal .....	109	107
<b>Crankcase oil filler pipe. (See Pipe, crankcase oil filler.)</b>		
<b>Curtains:</b>		
M38A1 .....	258	313
M170 .....	58, 268	49, 313
<b>Cushions. (See Seat and cushions.)</b>		
<b>Cylinder:</b>		
Compression test .....	106	102
<b>Cylinder, master. (See Master cylinder.)</b>		
<b>Cylinder, wheel. (See Wheel cylinder.)</b>		
<b>Data:</b>		
Detailed data references .....	7	18
General .....	7	18
Performance .....	7	18
Tabulated .....	7	18
Description, general .....	4	5
<b>Destruction to prevent enemy use:</b>		
Burning .....	288	365
Demolition .....	289	366
General .....	287	364
Gunfire .....	290	366
Differences between models .....	5	11

<b>Distributor:</b>		
<b>Breaker point capacitor:</b>		
Installation.....	151	173
Removal.....	151	173
<b>Breaker point set:</b>		
Adjustment.....	151	173
Installation.....	151	173
Removal.....	151	173
<b>Cap:</b>		
Installation.....	151	173
Removal.....	151	173
<b>Cover:</b>		
Installation.....	151	173
Removal.....	151	173
Maintenance after fording.....	276	349
<b>Primary capacitor:</b>		
Installation.....	151	173
Removal.....	151	173
<b>Distributor with coil assy:</b>		
Installation.....	150	171
Removal.....	150	171
<b>Doors. (See Curtains.)</b>		
<b>Drag link:</b>		
Assembly.....	227	268
Disassembly.....	227	268
Installation.....	227	268
Removal.....	227	268
<b>Driving light. (See Light, driving.)</b>		
<b>Driving, normal. (See Vehicle.)</b>		
<b>Drums, brake:</b>		
<b>Front:</b>		
Installation.....	209	251
Removal.....	209	251
<b>Rear:</b>		
Installation.....	219	212
Removal.....	219	212
<b>Electrical components and cables:</b>		
Circuit identification.....	171	212
General.....	171	212
Table IV.....	171	212
<b>Electrical system:</b>		
Description.....	4	5
Maintenance after fording.....	276	349
<b>Emergency reel lamp. (See Lamp, emergency reel.)</b>		
<b>Engine:</b>		
Cylinder compression test.....	106	102
Data.....	104	99
Description.....	4, 104	5, 99
External lines and fittings.....	118	122
Installation on power plant.....	123	132
Maintenance after fording.....	276	349
Operation in vehicle.....	105	102
Removal from power plant.....	122	132
Starting.....	42	33



	<i>Para-</i> <i>graphs</i>	<i>Page</i>
Engine—Continued		
Stopping .....	50	38
Troubleshooting .....	81	79
Engine oil pressure gage. ( <i>See Gages.</i> )		
Engine oil pressure sending unit. ( <i>See Sending units.</i> )		
Engine water temperature gage. ( <i>See Gages.</i> )		
Engine water temperature sending unit. ( <i>See Sending units.</i> )		
Exhaust manifold. ( <i>See Manifold, exhaust.</i> )		
Exhaust pipe. ( <i>See Pipe, exhaust.</i> )		
Exhaust pipe extension:		
Installation .....	145	165
Removal .....	145	165
Exhaust system:		
Description .....	143	164
Installation .....	144	164
Removal .....	144	164
Troubleshooting .....	83	84
External lines and fittings .....	118	122
Extreme-hot weather maintenance:		
Batteries .....	275	348
Body .....	275	348
Chassis .....	275	348
Cooling system .....	275	348
Fan:		
Installation .....	131	141
Removal .....	131	141
Fan and generator drive belt set. ( <i>See Belt set, fan and generator drive.</i> )		
Fasteners .....	282	352
Fenders:		
M38A1:		
Installation .....	256	307
Removal .....	256	307
M170:		
Installation .....	265	330
Removal .....	265	330
Filter, fuel:		
Element .....	139	156
Installation .....	138	155
Removal .....	138	155
Filter, oil:		
Element .....	114	117
Installation .....	115	118
Lines:		
Installation .....	116	120
Removal .....	116	120
Removal .....	115	118
Fording operations:		
After fording: Lubrication .....	73	68
General .....	64	55
Forms .....	3	4
Frame:		
M38A1:		
Data .....	253	304
Description .....	253	304

Frame—Continued		
	<i>Para-</i> <i>graphs</i>	<i>Page</i>
M170:		
Data.....	262	329
Description.....	262	329
Front axle. (See Axle, front.)		
Front axle shafts. (See Shafts, front axle, with universal joints.)		
Front hub bearings. (See Bearings, front hub.)		
Front hubs. (See Hubs.)		
Fuel and air intake system:		
Data.....	133	143
Description.....	133	143
Lines and fittings.....	142	161
Maintenance after fording.....	276	349
Troubleshooting.....	82	82
Fuel and vacuum pump:		
Installation.....	137	154
Removal.....	137	154
Fuel filter. (See Filter, fuel.)		
Fuel filter element. (See Filter, fuel.)		
Fuel gage. (See Gages.)		
Fuel level sending unit. (See Sending units.)		
Fuel lines. (See Fuel and air intake system and <i>specific item</i> .)		
Fuel tank. (See Tank, fuel, M170 or M38A1.)		
Gages:		
Ammeter. (See Ammeter (M38A1).)		
Battery generator indicator (M170). (See Indicator, battery generator (M170).)		
Fuel.....	175	222
General.....	172	216
Oil pressure.....	177	223
Speedometer. (See Speedometer.)		
Troubleshooting.....	90	90
Water temperature.....	176	223
Gaskets:		
Cylinder head.....	111	112
Exhaust manifold.....	113	117
Rocker arm cover.....	108	105
Valve compartment cover.....	109	107
Gate, tail. (See Tailgate.)		
Gearshift levers. (See <i>Transmission</i> or <i>Transfer</i> gearshift levers.)		
Generating system:		
Data.....	157	184
Description.....	157, 281	184, 351
Maintenance.....	281	351
Troubleshooting.....	86	86
Generator:		
Installation.....	158	184
Removal.....	158	184
Generator regulator (M38A1). (See Regulator, generator.)		
Generator regulator (M170). (See Regulator, generator.)		
Glove compartment door lock.....	27	30

	<i>Para-</i> <i>graphs</i>	<i>Page</i>
Hand brake. (See Brake, hand.)		
Headlight dimmer switch. (See Switches.)		
Headlight high beam indicator light.....	180	226
Headlights:		
Adjustment.....	163	201
Installation.....	163	201
Lamp unit with cable assy:		
Installation.....	163	201
Removal.....	163	201
Removal.....	163	201
Hood:		
M38A1.....	255	306
M170.....	264	330
Horn:		
General.....	172	216
Installation.....	184	228
Removal.....	184	228
Troubleshooting.....	89	89
Horn button cap. (See Cap, horn button.)		
Horn switch. (See Switches.)		
Hose:		
Water inlet.....	129	139
Water outlet.....	129	139
Water pump bypass.....	129	139
Hub bearing oil seal.....	211	252
Hubs:		
Front.....	210	252
Rear.....	220	263
Ignition coil. (See Coil, ignition.)		
Ignition switch. (See Switches.)		
Ignition system:		
Data.....	147	167
Description.....	147	167
Organizational maintenance.....	148	170
Timing.....	149	170
Troubleshooting.....	84	84
Indicator, battery generator (M170):		
Installation.....	174	219
Removal.....	174	219
Instrument cluster:		
General.....	172	216
Installation.....	173	216
Removal.....	173	216
Instrument panel lights.....	179	224
Instruments:		
General.....	172	216
Troubleshooting.....	90	90
(See also Controls and instruments.)		
Insulator, throttle valve body-to-manifold. (See carburetor.)		
Joints, universal. (See Universal joints.)		
Lamp, emergency reel:		
Installation.....	170	211
Lamp-unit replacement.....	170	211
Removal.....	170	211

	<i>Para-</i> <i>graphs</i>	<i>Page</i>
Lifting shackles (M170)-----	271	343
Light switch. (See Switches.)		
Lights:		
Blackout driving. (See Blackout driving lights.)		
Blackout marker. (See Signal blackout marker lights.)		
Headlights. (See Headlights.)		
High beam indicator. (See Headlight high beam indicator light.)		
Instrument. (See Instrument panel lights.)		
Parking. (See Parking lights, service.)		
Tail and stop. (See Tail and stoplights.)		
Litter racks. (See Racks, litter.)		
Lubrication:		
After fording operations-----	73	68
After operation under dusty or sandy conditions-----	74	68
Chart-----	69	59
Continued operation below 0° F-----	72	68
Equipment-----	70	59
General-----	70	59
Points of application-----	70	59
Unusual conditions-----	71	67
Usual conditions-----	70	59
Maintenance after fording:		
Aluminum or magnesium parts-----	276	349
Axles-----	276	349
Batteries-----	276	349
Body-----	276	349
Brakes-----	276	349
Chassis-----	276	349
Condensation-----	276	349
Deep water fording-----	276	349
Distributor-----	276	349
Electrical connections-----	276	349
Engine-----	276	349
Fuel system-----	276	349
General-----	276	349
Steering gear-----	276	349
Transfer case-----	276	349
Transmission-----	276	349
Wheels-----	276	349
Maintenance after operation on unusual terrain-----	277	350
Maintenance under unusual conditions:		
Extreme cold weather maintenance-----	274	348
Extreme cold weather problems-----	273	347
Extreme hot weather maintenance-----	275	348
Manifold, exhaust:		
Installation-----	112	116
Removal-----	112	116
Manifold vacuum test-----	107	103
Master cylinder:		
Filling-----	234	280
Installation-----	234	280
Removal-----	234	280

	<i>Para-</i> <i>graphs</i>	<i>Page</i>
Mirrors:		
M38A1:		
Outside rear view.....	259	316
M170.....	270	343
Motor, vacuum, windshield wiper. (See Windshield wiper).		
Name, data, caution, and instruction plates.....	6	12
Oil filter. (See Filter, oil.)		
Oil filter element. (See Filter, oil.)		
Oil filter lines. (See Filter, oil.)		
Oil seal, steering knuckle flange. (See Steering knuckle flange oil seal.)		
Operation of ambulance equipment:		
General.....	53	41
Operation under unusual conditions:		
Extreme-cold weather conditions.....	60	51
Extreme-cold weather operation.....	61	52
Extreme-hot weather conditions.....	62	53
Fording operations.....	64	55
General.....	59	50
Operation on unusual terrain.....	63	54
Operation under usual conditions:		
General.....	41	33
Organizational maintenance allocation.....	2	3
Organizational maintenance instruction:		
General.....	65	57
Painting.....	75	69
Parking lights, service.....	165	206
Parking the vehicle. (See Vehicle.)		
Parts.....	66	57
Pedal, accelerator:		
Adjustment.....	135	147
Hinge.....	135	147
Hinge spring.....	135	147
Installation.....	135	147
Removal.....	135	147
Pedal, service brake:		
Installation.....	230	271
Removal.....	230	271
Pintle, towing. (See towing pintle.)		
Pipe, crankcase oil filler:		
Installation.....	117	121
Removal.....	117	121
Service.....	117	121
Pipe, exhaust:		
Installation.....	146	166
Removal.....	146	166
Power plant:		
M38A1:		
Installation.....	124	132
Removal.....	120	123
M170:		
Installation.....	125	135
Removal.....	121	131

	Para- graphs	Page
Preliminary services.....	9	20
Preventative maintenance services:		
Cleaning.....	77	70
Daily "A" and biweekly "B" services:		
Table II.....	78	71
General.....	76	69
Mileage "C" and "D" services:		
Table III.....	79	73
Primary capacitor. (See distributor.)		
Propeller shaft. (See Shafts, propeller with universal joints, <i>front</i> or <i>rear</i> .)		
Propeller shafts with universal joints. (See Shaft, propeller with universal joints.)		
Pump, fuel and vacuum. (See Fuel and vacuum pump.)		
Pump, water. (See Water pump.)		
Racks, litter (M17D):		
General.....	54	41
Lower:		
Installation.....	269	340
Removal.....	269	340
Upper:		
Installation.....	269	340
Lowering.....	54	41
Raising.....	54	41
Removal.....	269	340
Stowing.....	54	41
Radiator guard with deflector:		
M38A1:		
Installation.....	257	311
Removal.....	257	311
M170:		
Installation.....	266	331
Removal.....	266	331
Radiator with shroud:		
Installation.....	128	138
Removal.....	128	138
Radio interference suppression system:		
Description.....	279, 280	351
Maintenance.....	280	351
Purpose.....	278	351
Troubleshooting.....	91	91
Rear axle shaft bearings. (See Bearings, rear axle shaft.)		
Rear axle shaft oil seals. (See Shafts, rear axle.)		
Rear axle shafts. (See Shaft, rear axle.)		
Rear hubs. (See Hubs.)		
Receptacle, trailer coupling electrical connector:		
Installation.....	169	211
Removal.....	169	211
Records.....	3	4
Reflectors:		
M38A1:		
Rear reflex.....	259	316
M170.....	270	343

	<i>Para-</i> <i>graphs</i>	<i>Page</i>
<b>Regulator, generator:</b>		
<b>M38A1:</b>		
Installation .....	159	190
Removal .....	159	190
<b>M170:</b>		
Installation .....	160	192
Removal .....	160	192
Reports .....	3	4
Reversing the vehicle. ( <i>See Vehicle.</i> )		
<b>Red, throttle:</b>		
Installation .....	135	147
Removal .....	135	147
<b>Scope</b> .....	1	3
<b>Seats and cushions:</b>		
<b>M38A1:</b>		
Driver's .....	261	325
Passenger .....	261	325
Rear .....	261	325
<b>M170:</b>		
Driver's .....	272	343
General .....	55	43
Passenger .....	272	343
Wheel house .....	272	343
<b>Sending units:</b>		
<b>Fuel level:</b>		
Installation .....	189	229
Removal .....	189	229
General .....	172	216
<b>Oil pressure:</b>		
Installation .....	187	229
Removal .....	187	229
Troubleshooting .....	90	90
<b>Water temperature:</b>		
Installation .....	188	229
Removal .....	188	229
Service brake pedal. ( <i>See Pedal, service brake.</i> )		
Service brakes. ( <i>See Brake, service.</i> )		
<b>Shackles, lifting:</b>		
<b>M38A1:</b>		
Installation .....	250	300
Removal .....	260	322
<b>M170</b> .....	271	343
Shackles, spring. ( <i>See Springs.</i> )		
<b>Shaft, front propeller with universal joints:</b>		
Data .....	201	239
Description .....	201	239
Installation .....	202	240
Removal .....	202	240
Troubleshooting .....	95	94
<b>Shaft, rear propeller with universal joints:</b>		
Data .....	201	239
Description .....	201	239
Installation .....	203	241
Removal .....	203	241
Troubleshooting .....	95	94

	<i>Para-</i> <i>graphs</i>	<i>Page</i>
<b>Shafts, front axle with universal joints:</b>		
Installation.....	207	245
Removal.....	207	245
<b>Shafts, rear axle:</b>		
Cleaning and packing.....	216	259
Inner oil seal.....	218	262
Installation.....	216	259
Outer oil seal.....	218	262
Removal.....	216	259
<b>Shipment and limited storage:</b>		
Blocking.....	286	358
Domestic shipping instructions.....	283	353
Limited storage instructions.....	284	354
Loading.....	285	355
<b>Shock absorbers. (See Absorbers, shock.)</b>		
<b>Side curtains (M170):</b>		
Installation.....	268	335
Removal.....	268	335
<b>Signal blackout marker lights.....</b>	165	206
<b>Spare wheel. (See Wheel.)</b>		
<b>Spark plugs:</b>		
Cables.....	153	179
Installation.....	153	179
Removal.....	153	179
<b>Special tools and equipment:</b>		
Table I.....	68	57
<b>Speedometer:</b>		
Flexible shaft core replacement.....	178	223
Installation.....	178	223
Removal.....	178	223
<b>Spring pivot bolts. (See Bolts, spring pivot.)</b>		
<b>Spring shackles:</b>		
<b>M38A1:</b>		
Installation.....	242	293
Removal.....	242	293
<b>M170:</b>		
Installation.....	243	294
Removal.....	243	294
<b>Springs:</b>		
<b>M38A1:</b>		
Data.....	239	290
Description.....	239	290
Installation.....	245	297
Organizational maintenance.....	241	291
Removal.....	245	297
Shackles.....	242	293
Troubleshooting.....	101	97
<b>M170:</b>		
Data.....	240	291
Description.....	240	291
Installation.....	246	298
Organizational maintenance.....	241	291
Removal.....	246	298
Shackles.....	243	294
Troubleshooting.....	101	97



	<i>Para-</i> <i>graphs</i>	<i>Page</i>
Stabilizer bar (M170):		
Installation.....	267	333
Removal.....	267	333
Starter:		
Installation.....	155	180
Removal.....	155	180
Starter switch. (See Switches.)		
Starting system:		
Data.....	154	180
Description.....	154	180
Troubleshooting.....	85	86
Steering bellcrank. (See Bellcrank, steering.)		
Steering gear:		
Adjustment.....	230	271
Installation.....	230	271
Maintenance after fording.....	276	349
Removal.....	230	271
Steering knuckle flange bearings. (See Bearings, steering knuckle flange.)		
Steering knuckle flange cap:		
Installation.....	213	253
Removal.....	213	253
Steering knuckle flange oil seal:		
Installation.....	212	252
Removal.....	212	252
Steering system:		
Data.....	222	264
Description.....	222	264
Organizational maintenance.....	223	265
Troubleshooting.....	102	98
Steering wheel:		
Installation.....	229	270
Removal.....	229	270
Stoplight switch. (See Switches.)		
Stopping the vehicle. (See Vehicle.)		
Storage. (See Shipment and limited storage.)		
Switches:		
General.....	172	216
Headlight dimmer.....	183	228
Horn.....	185	229
Ignition.....	181	226
Light.....	182	227
Starter.....	156	183
Stoplight.....	186	229
Troubleshooting.....	90	90
Tables:		
Table I—Special tools and equipment.....	68	57
Table II— Daily "A" and biweekly "B" preventive maintenance services.....	78	71
Table III—Mileage "C" and semiannual—mileage "D" preventive maintenance services.....	79	73
Table IV—Circuit numbers and descriptions.....	171	212
Tabulated data.....	7	18

	<i>Para-</i> <i>graphs</i>	<i>Page</i>
<b>Tail and stop lights:</b>		
Blackout.....	166	207
Service.....	167	209
<b>Tailgate:</b>		
General.....	56	47
Lowering.....	56	47
Raising.....	56	47
<b>Tank, fuel:</b>		
<b>M38A1:</b>		
Installation.....	140	157
Removal.....	140	157
<b>M170:</b>		
Installation.....	141	159
Removal.....	141	159
<b>Thermostat, water temperature:</b>		
Installation.....	132	142
Removal.....	132	142
<b>Throttle control. (See Control, throttle.)</b>		
<b>Throttle rod. (See Rod, throttle.)</b>		
<b>Tie rod ends:</b>		
Installation.....	226	268
Removal.....	226	268
<b>Tie rod with ends:</b>		
Installation.....	225	266
Removal.....	225	266
<b>Timing.....</b>	149	170
<b>Tires and tubes:</b>		
Data.....	248	299
Description.....	248	299
Organizational maintenance.....	249	300
Removal and installation.....	252	304
Spare wheel and tire.....	251	302
Troubleshooting.....	100	97
<b>Toe-in adjustment.....</b>	224	265
<b>Top rails (M170):</b>		
Installation.....	268	335
Removal.....	268	335
<b>Towing pintle:</b>		
M38A1.....	260	322
M170.....	271	343
<b>Towing the vehicle. (See Vehicle.)</b>		
<b>Trailer coupling electrical connector receptacle. (See Receptacle, trailer coupling electrical connector.)</b>		
<b>Transfer:</b>		
Data.....	197	236
Description.....	4, 197	5, 236
Gears, shifting.....	46	36
Installation.....	200	238
Maintenance after fording.....	276	349
Removal.....	199	237
Troubleshooting.....	94	93
<b>Transfer gearshift levers:</b>		
Installation (M38A1).....	124	132
Installation (M170).....	125	135
Operation.....	43, 46	34, 36

	<i>Para-</i> <i>graphs</i>	<i>Page</i>
<b>Transfer gearshift levers—Continued</b>		
Removal (M38A1).....	120	123
Removal (M170).....	121	131
<b>Transmission:</b>		
Data.....	192	232
Description.....	4, 192	5, 232
Installation.....	196	234
Maintenance after fording.....	276	349
Organizational maintenance.....	194	233
Removal.....	195	233
Shifting.....	45	35
Troubleshooting.....	93	93
<b>Transmission gearshift lever:</b>		
Installation (M38A1).....	124	132
Installation (M170).....	125	135
Operation.....	43, 45	34, 35
Removal (M38A1).....	120	123
Removal (M170).....	121	131
<b>Troubleshooting:</b>		
Batteries and lighting system.....	87	87
Clutch.....	92	92
Cooling system.....	88	88
Engine.....	81	79
Exhaust system.....	83	84
Front axle.....	96	94
Fuel and air intake system.....	82	82
Gages.....	90	90
Generating system.....	86	86
Hand brake.....	99	97
Horn.....	89	89
Ignition system.....	84	84
Instruments.....	90	90
Propeller shafts.....	95	94
Rear axle.....	97	95
Scope.....	80	79
Sending units.....	90	90
Service brakes.....	98	95
Shock absorber.....	101	97
Springs.....	101	97
Starting system.....	85	86
Steering system.....	102	98
Switches.....	90	90
Tires.....	100	97
Transfer.....	94	93
Transmission.....	93	93
Universal joint.....	95	94
Wheels.....	100	97
Windshield wipers.....	103	99
<b>Universal joints (See also Shaft, propeller, with universal joints, front or rear and shafts, front axle, with universal joints):</b>		
Assembly.....	204	241
Disassembly.....	204	241
Troubleshooting.....	95	94
<b>Unsatisfactory equipment.....</b>	<b>3</b>	<b>4</b>

Vacuum pump. (See Fuel and vacuum pump.)

Valve, windshield wiper air regulating. (See Windshield wipers.)

Vehicle:

	<i>Para-</i> <i>graphs</i>	<i>Page</i>
Normal driving.....	44	35
Parking.....	48	38
Placing in motion.....	43	34
Reversing.....	49	38
Shifting gears in transfer.....	46	36
Shifting transmission.....	45	35
Stopping.....	47	37
Towing.....	52	39

Warning:

Exhaust system.....	83	84
---------------------	----	----

Water pump:

Installation.....	131	141
Removal.....	131	141

Water pump pulley:

Installation.....	131	141
Removal.....	131	141

Wheel cylinder:

Installation.....	235	282
Removal.....	235	282

Wheel, steering. (See Steering wheel.)

Wheels:

Data.....	248	299
Description.....	248	299
Installation.....	250	300
Maintenance after fording.....	276	349
Organizational maintenance.....	249	300
Removal.....	250	300
Spare wheel.....	251	302
Troubleshooting.....	100	97

Windshield:

M38A1:		
Lowering.....	254	305
Raising.....	254	305
M170.....	263	330

Windshield wipers:

M38A1:		
Adjustable arm.....	259	316
Air regulating valve.....	259	316
Blade.....	259	316
Lines and hoses.....	259	316
Motor.....	259	316
Troubleshooting.....	103	99
M170:		
General.....	270	343
Troubleshooting.....	103	99

Yoke, sleeve universal joint:

General.....	205	244
Installation.....	205	244
Removal.....	205	244

BY ORDER OF THE SECRETARIES OF THE ARMY AND THE AIR FORCE :

M. B. RIDGWAY,  
*General, United States Army,*  
*Chief of Staff.*

OFFICIAL :

JOHN A. KLEIN,  
*Major General, United States Army,*  
*The Adjutant General.*

N. F. TWINING,  
*Chief of Staff, United States Air Force.*

OFFICIAL :

E. E. TORO,  
*Colonel, United States Air Force,*  
*Air Adjutant General.*

DISTRIBUTION :

*Active Army:*

Tec Svc, DA (1)  
Ord Bd (2)  
CONARC (3)  
Army AA Comd (2)  
OS Maj Comd (5)  
OS Base Comd (2)  
Log Comd (3)  
MDW (1)  
Armies (3)  
Corps (2)  
Div (2)  
Brig (2)  
Ord Gp (2)  
Regt/Gp (1)  
Ord Bn (2)  
Bn (1)  
Ord Co (2)  
Co (1)  
Ft & Cp (2)  
Gen & Br Svc Sch (2)  
Ord Sch (50)  
PMST Ord ROTC units (1)  
Gen Depots (2)  
Ord Sec, Gen Depots (5)  
Ord Depots (10)  
POE (2)  
OS Sup Agencies (1)

ORD PG (10)  
Ord Arsenals (5)  
Mil Dist (1)  
Ord Proc Dist (10)  
MAAG (1)  
Mil Msn (1)

*Units organized under following TOE's:*

9-12A, Hq & Hq Co., Maint & Sup Gp, Ammo (1).  
9-17, Ammo Co, Army (1)  
9-45A, Sp Wpn Spt or Depot Bn (1)  
9-46A, Hq & Hq Det, Sp Wpns Spt or Depot Bn (1)  
9-47A, Sp Wpns Spt or Depot Co (1)  
9-49, Sp Wpns Dir Spt Co (1)  
9-57A, Fld Sup Co (1)  
9-229, ORD GM Dir Spt Co (1)  
9-347, Ord Tire Rebuild Co (1)  
9-367, Sup Depot Co (1)  
9-387, Ammo Depot Co (1)

NG: Same as Active Army except allowance is one copy to each unit.

USAR: None.

For explanation of abbreviations used, see SR 320-50-1.